

BIXOLON®

User's Manual

SPP-R400

Mobile Printer

Rev. 1.02

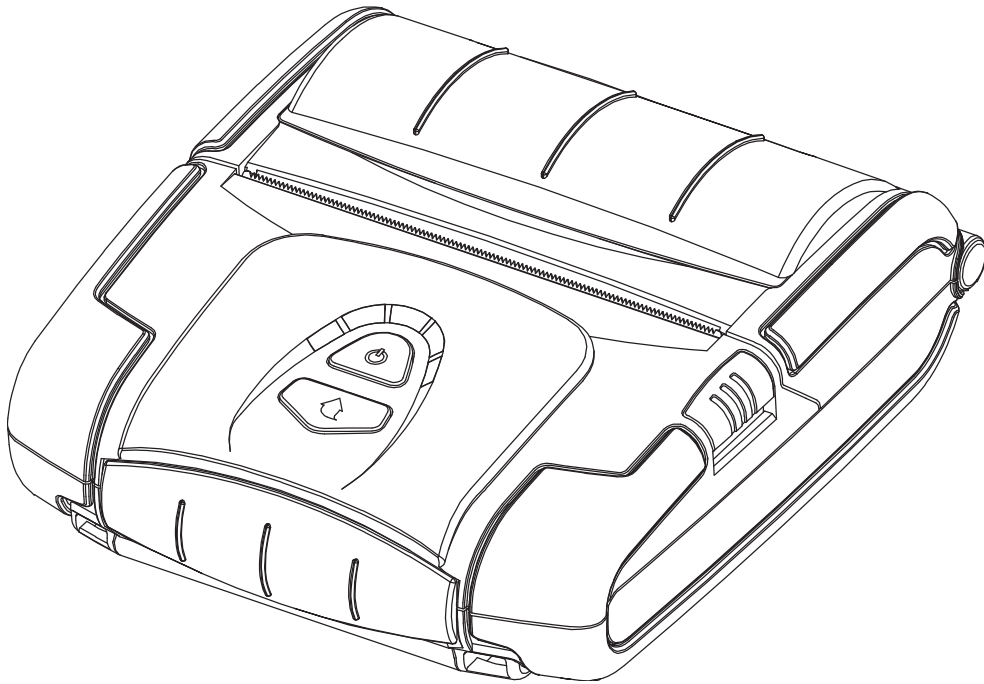

<http://www.bixolon.com>

■ Table of Contents

※ Manual Information & Usage Precautions	3
1. Content Confirmation	10
2. Product Part Names.....	11
3. Installation & Usage.....	12
3-1 Battery Installation	12
3-2 Battery Charging	12
3-2-1 Using Battery Charger	12
3-2-2 Using Single Battery Cradle (Optional).....	13
3-2-3 Using Vehicle Charger (Optional)	13
3-2-4 Using Quad Battery Charger (Optional)	14
3-3 Paper Installation.....	16
3-4 Using Belt Strap	17
3-5 Using Case, Protective Case (Optional).....	18
3-6 Using Shoulder Strap (Optional)	19
3-7 Adjusting Paper Guide	20
3-8 Using Control Panel	21
3-9 Using MSR.....	22
4. Self-Test.....	22
5. Label Printing Function.....	25
5-1 Label Function Setting	25
5-2 Auto Calibration Function	25
6. Peripherals Connection.....	26
6-1 Bluetooth & Wireless LAN Connection.....	26
6-2 Interface Cable Connection.....	26
7. Printer Cleaning	27
8. Appendix.....	28
8-1 Specifications	28
8-2 Certification	29
8-3 Label Types.....	30

■ Manual Information

This user's manual contains basic information for product usage as well as for emergency measures that may be required.

※ The following separate manuals provide more detailed content on various technological issues and areas.

1. Windows CE Module Program Manual

This manual provides information on the dll files required for Windows CE application program development.

2. Windows Driver Manual

This manual provides information on installation and main functions of the Windows Driver for this product.

3. Unified Utility Manual

This manual provides information on the software used to select functions of this product, modify operation conditions, etc.

- VMSM (Virtual Memory Switch Manager)
: As a function that sets the basic operation conditions of the product, the use of non-hardware control, software-based virtual switches is explained.
- NV Image Download Manager
: The downloading of image files, such as logos, intended for repetitive printing is explained.
- Firmware Download Manager
: The downloading and installation of the latest Firmware, which is subject to ongoing modification for the enhancement of product performance, are explained.

4. Bluetooth & Wireless Manual

- Bluetooth
: This manual describes how to connect terminals (PDAs, PCs, etc.) with Bluetooth functionality.
- Wireless LAN
: This manual describes how to connect wireless LAN in infrastructure or ad-hoc mode.

5. Commands Manual

This manual provides information on the protocol and functions of the control commands that can be used with this product.

6. Code Pages Manual

This manual provides information on each character code page that can be used with this product.

We at BIXOLON maintain ongoing efforts to enhance and upgrade the functions and quality of all our products. In following, product specifications and/or user manual content may be changed without prior notice.

■ Safety Precautions

In using the present appliance, please keep the following safety regulations in order to prevent any hazard or material damage.



WARNING

Violating following instructions can cause serious injury or death.

Do not plug several products in one multi-outlet.

- This can provoke over-heating and a fire.
- If the plug is wet or dirty, dry or wipe it before usage.
- If the plug does not fit perfectly with the outlet, do not plug in.
- Be sure to use only standardized multi-outlets.

PROHIBIT

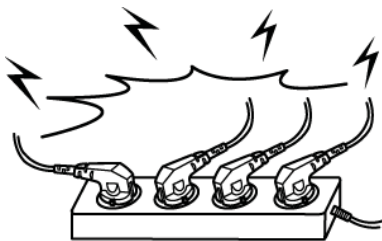

You must use only the supplied adapter.

- It is dangerous to use other adapters.

PROHIBIT



Do not pull the cable to unplug.

- This can damage the cable, which is the origin of a fire or a breakdown of the printer.

PROHIBIT

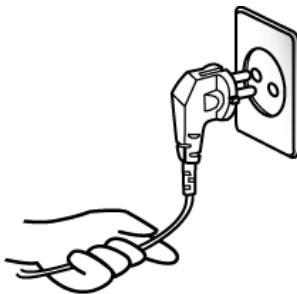

Keep the plastic bag out of children's reach.

- If not, a child may put the bag on his head.

PROHIBIT



Do not plug in or unplug with your hands wet.

- You can be electrocuted.

PROHIBIT

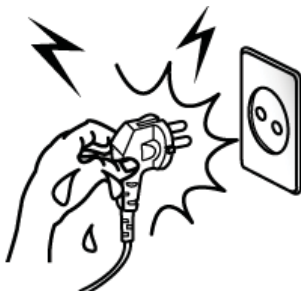

Do not bend the cable by force or leave it under any heavy object.

- A damaged cable can cause a fire.

PROHIBIT

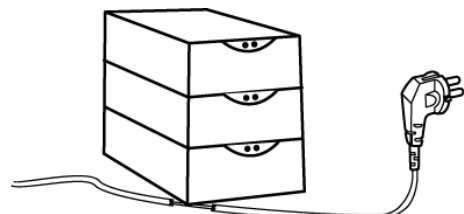



CAUTION

Violating following instructions can cause slight wound or damage the appliance.

If you observe a strange smoke, odor or noise from the printer, unplug it before taking following measures.

- Switch off the printer and unplug the set from the mains.
- After the disappearance of the smoke, call your dealer to repair it.

TO UNPLUG



Keep the desiccant out of children's reach.

- If not, they may eat it.

PROHIBIT



Install the printer on the stable surface.

- If the printer falls down, it can be broken and you can hurt yourself.

PROHIBIT

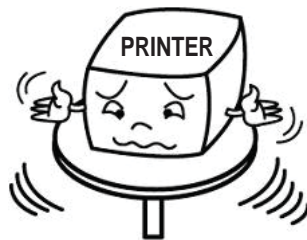

Use only approved accessories and do not try to disassemble, repair or remodel it for yourself.

- Call your dealer when you need these services.
- Do not touch the blade of auto cutter.

DISASSEMBLING PROHIBITED

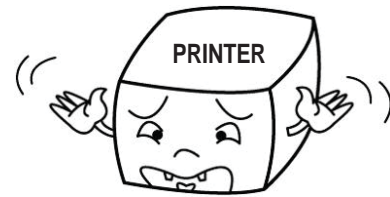

Do not let water or other foreign objects in the printer.

- If this happened, switch off and unplug the printer before calling your dealer.

PROHIBIT



Do not use the printer when it is out of order. This can cause a fire or an electrocution.

- Switch off and unplug the printer before calling your dealer.

TO UNPLUG



■ Battery Safety Precautions

Make sure to review the user manual carefully prior to product use.

Neglecting to heed the following instructions can result in battery overheating, combustion, explosion, damage and/or decline in performance and product life.

⚠ Danger

1. Do not allow water, seawater or moisture to enter or leak into the battery. If the safety mechanism within the battery becomes oxidized, the battery may overcharge with abnormal electrical current and/or voltage so that it may overheat, ignite and/or explode.
2. Do not place the battery near open flames or heating devices, such as stoves. Exposure to excessive heat may cause damage to the resin case and/or insulating materials, thus causing a short circuit within the battery that may result in battery overheating, combustion, and/or explosion.
3. Charge the battery only with the exclusive charger specified (optionally provided) by BIXOLON. The use of an incorrect charger may result in overheating, combustion and/or explosion of the battery.
4. Charging the battery with a modified charger may result in overheating, combustion and/or explosion of the battery by abnormal chemical reaction caused by incorrect polarity.
5. Do not directly connect the battery to an electrical power outlet not specified by BIXOLON or an automobile's cigarette lighter jack. Doing so may result in overheating, combustion and/or explosion of the battery by over-current and/or over-voltage.
6. Do not heat the battery or place it near a fire. Doing so may melt insulation materials, damage the safety mechanism/equipment, and/or ignite the electrolytic solution. There is a potential risk of battery overheating, combustion, and/or explosion.
7. Do not reverse the connection of (+) and (-) electrodes of the battery. Charging the battery in reverse polarity may produce an undesired chemical reaction inside the battery cell, causing unexpected behavior during discharging such as overheating, explosion, or fire.
8. Do not allow the battery's (+) or (-) pole to come into contact with any metal. In addition, do not carry or store the battery with metallic items, such as necklaces and hairpins. Doing so may cause a short circuit of the battery generating an over-current. There is the potential risk to overheat, ignite and/or explode the battery or overheat the metallic items, such as necklaces, hair pins etc.
9. Do not throw the battery or subject it to strong shock. If the safety mechanism in the battery is damaged, the battery may be overcharged and, consequently, an adverse chemical reaction may be generated in the battery. There is a potential risk of battery overheating, combustion, and/or explosion.

10. Do not pierce the battery with a pointed object, such as nail or awl, or strike with a heavy object, such as a hammer, and take care not to step on the battery. There is a potential risk of battery overheating, combustion, and/or explosion caused by an internal short circuit.
11. Do not solder the battery directly. Doing so may melt the insulating materials and/or damage the safety mechanism or safety equipment, resulting in battery overheating, combustion, and/or explosion.
12. Do not disassemble and/or modify the battery. The battery contains safety equipment and a safety mechanism to prevent danger. There is a potential risk of overheating, combustion, and/or explosion caused by disassembly.
13. Do not charge the battery near open flames and/or under direct sunlight. Because exposure to high temperatures triggers the operation of the safety mechanism, the battery may not charge or may overcharge due to destruction of the safety mechanism. There is a potential risk of overheating, combustion, and/or explosion.
14. Do not expose the battery to high temperatures over 60 °C, and do not use or store it in a hot or humid place.

Warning

1. Do not place the battery within the reach of small children to prevent any swallowing accidents. If a small child has swallowed the battery, consult a physician immediately.
2. Do not place the battery in a microwave oven or a high pressure unit. Doing so may cause sudden overheating of the battery and/or the destruction of its seal, resulting in battery overheating, combustion, and/or explosion.
3. Do not use the battery with primary batteries like dry cells or other batteries of different capacity or type. Doing so may cause excessive discharge in use or excessive charge when charging it, resulting in an abnormal chemical reaction within the battery that can cause battery overheating, combustion, and/or explosion. There is a potential risk of overheating, combustion, and/or explosion due to adverse chemical reaction in the battery.
4. If the battery starts to emit strange smells, or if you find unusual symptoms, such as overheating, discoloration and deformation, remove the battery from the product or the charger and discontinue use of the battery. The use of the battery in abnormal status may result in battery overheating, combustion, and/or explosion.
5. If the battery is not charged during a certain time when trying to recharge, discontinue charging. There is a potential risk of overheating, combustion, and/or explosion.
6. If battery leaks its electrolyte or gives off a strange smell, keep the battery away from open flames immediately. The leaked electrolyte may catch fire. There is a potential risk of overheating, combustion, and/or explosion.
7. If the battery is leaking electrolytic solution and any of the solution enters the eyes, immediately wash out with clean water, and then consult a physician to receive treatment. Neglecting to do so can cause permanent eye injuries.

⚠ Caution

Risk of explosion if Battery is replaced by an incorrect type.

Dispose of used Batteries according to the instructions.

1. Do not use or leave the battery in a location exposed to high temperatures or intense direct sunlight, such as within an automobile. Doing so can cause battery overheating and/or combustion. In addition, battery performance and product life may be reduced.
2. The battery contains a safety mechanism to prevent danger. Do not use the battery in a location that is prone to static electricity (above the amount covered by the manufacturer's product warranty) that can cause damage to this safety mechanism. Damage to the safety mechanism can result in battery overheating, combustion, and/or explosion.
3. The temperature ranges for battery usage are as follows. Any usage outside of these ranges can result in battery overheating and/or damage. In addition, battery performance and product life may be reduced.
 - Charging: 0 ~ 40°C
 - Product Usage: -20 ~ 60°C
 - Storage: -20 ~ 60°C (30 days)
 - Long-Term Storage: -20 ~ 40°C (90 days)
4. Please review the exclusive charger manual carefully for charging instructions.
5. If you observe any abnormal symptom, such as strange smell and overheating, on first use after purchasing the product, contact your local dealer immediately.
6. If a child must use the battery, the child's parent or legal guardian should clearly explain the instructions from the user manual prior to use. In addition, the parent or legal guardian should periodically confirm that usage is being conducted in accordance with user manual instruction during use.
7. Store the battery in a location that is out of the reach of small children. During usage, make sure to also place the charger and/or product out of the reach of small children.
8. If the battery is leaking electrolytic solution, and the solution comes in contact with the skin or clothing, immediately wash thoroughly with clean water. Contact with skin can result in skin disorders.
9. Make sure to review the user manual and precautions carefully prior to use. In addition, after carefully reviewing the user manual and precautions, place them in a secure location for future reference when needed.
10. There is a risk of explosion when replacing with an incorrect battery. Only exchange it for another one of the same or equivalent model specified by BIXOLON. Insulate the used battery by attaching insulation tape to its port, and then dispose of the battery according to local regulations.
11. If using the printed side of preprinted paper, this may cause malfunction.

⚠ Recommended

1. Review the user manual for instructions concerning insertion/removal of batteries into/from the product.
2. As the battery is slightly charged upon factory shipment, use it to confirm proper product operation upon purchase. If product operation cannot be confirmed or longer use of the product is required, use the exclusive charger to charge the battery.
3. To avoid improper use of the battery, review the product user manual carefully.
4. Do not charge the battery for long times in excess of the normal charging time indicated in the user manual.
5. If the battery is not to be used for a long period of time, remove it from the product and store in a location with low humidity. If the battery is stored while still inserted in the product in a highly humid location, oxidization may occur along with a decline in battery performance.
6. After product usage, make sure to turn power off. Neglecting to do so can cause a decline in battery performance.
7. A battery that has not been used over a long period of time may not be sufficiently charged. Even if the battery is not to be used, charge the battery to the status recommended by the manufacturer once every six months. Neglecting to do so can cause a decline in battery performance and product life.
8. If the battery terminal is dirty, use a dry cloth to wipe clean prior to use. Neglecting to do so can result in poor connection with the product causing power stoppages or failed charging.
9. Each battery has a life cycle. If the usage time of the produce is shortened, replace with a new battery. Insulate the used battery by attaching insulation tape to its port, and then dispose of the battery according to local regulations.

■ Other Precautions

The copyright for this user manual and various other manuals is property of the BIXOLON Co., Ltd. Any copying or conversion into electronic form and saving of this material without the express written permission of BIXOLON Co., Ltd. is strictly prohibited.

Use of the information contained in this manual is not subject to any patent liability. This manual has been prepared with utmost care and attention to detail but may contain certain errors and/or omissions.

BIXOLON Co., Ltd. is not legally liable for any damages resulting from the use of the information in this manual.

BIXOLON Co., Ltd. and its affiliates are not legally liable (United States excluded) for any damages, loss, costs, and/or expenses that result from the breakdown, malfunction, and/or misuse of the product due to violation or neglect of the operation and maintenance information and instructions provided by the BIXOLON Co., Ltd., as well as from the unauthorized alteration, repair, and/or modification of the product by the user and/or third party.

BIXOLON Co., Ltd. is not legally liable for any damages and/or issues resulting from the use of options and/or parts that are not authentic BIXOLON products or authorized products.

1. Content Confirmation

The following items should all be contained in the printer package. Contact the dealer from which the purchase was made if any item is damaged and/or missing.

※ Basic items

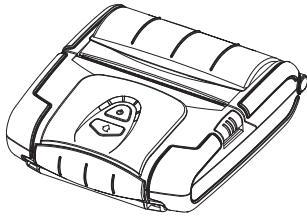

SPP-R400

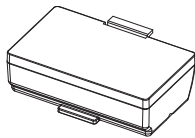

Battery Pack

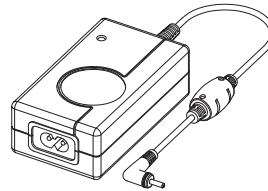

Battery Charger

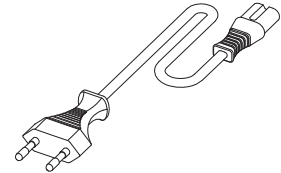

Power cord

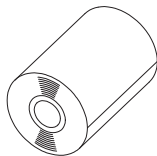

Paper

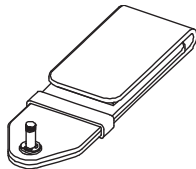

Belt Strap

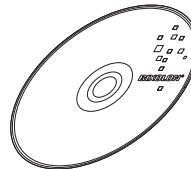

CD

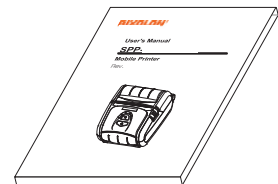

User Manual

※ Optional items

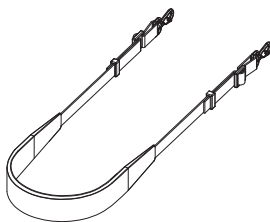

Shoulder Strap

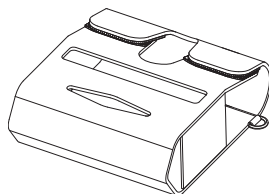

Case

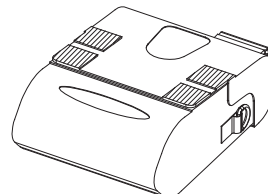

Protective Case

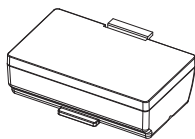

Battery Pack

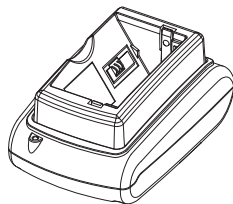

Single Battery Cradle

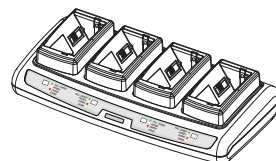

Quad Battery Charger

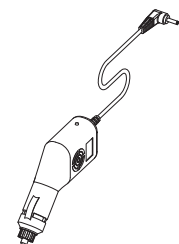

Vehicle Charger

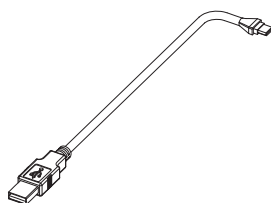

Interface Cable

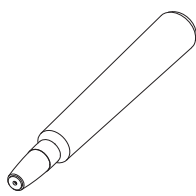

Cleaning Pen

2. Product Part Names

• Front

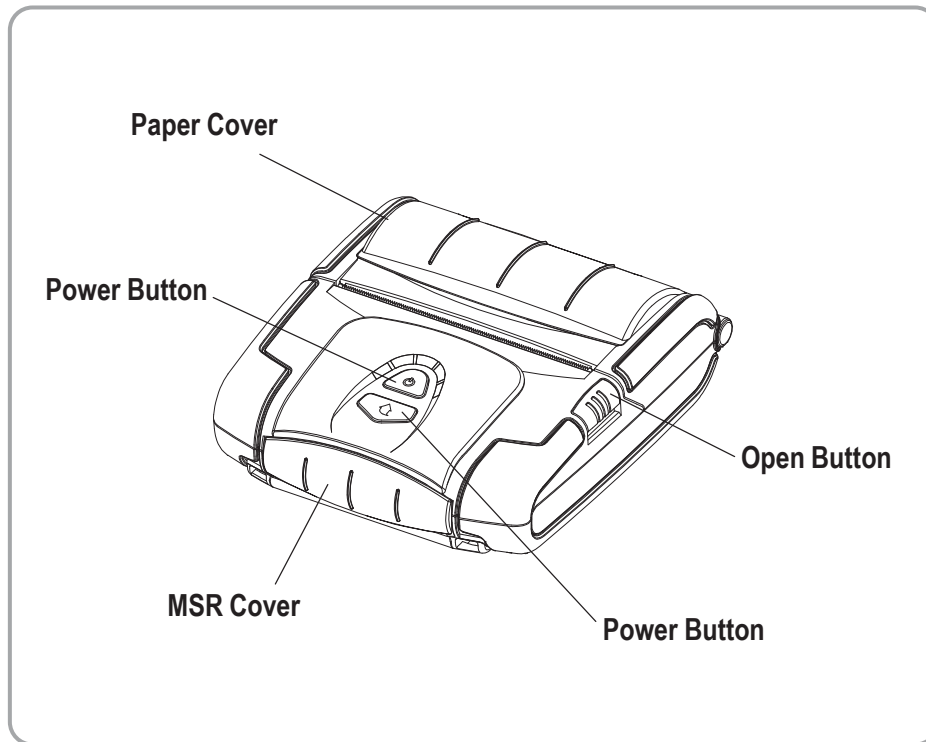

• Rear

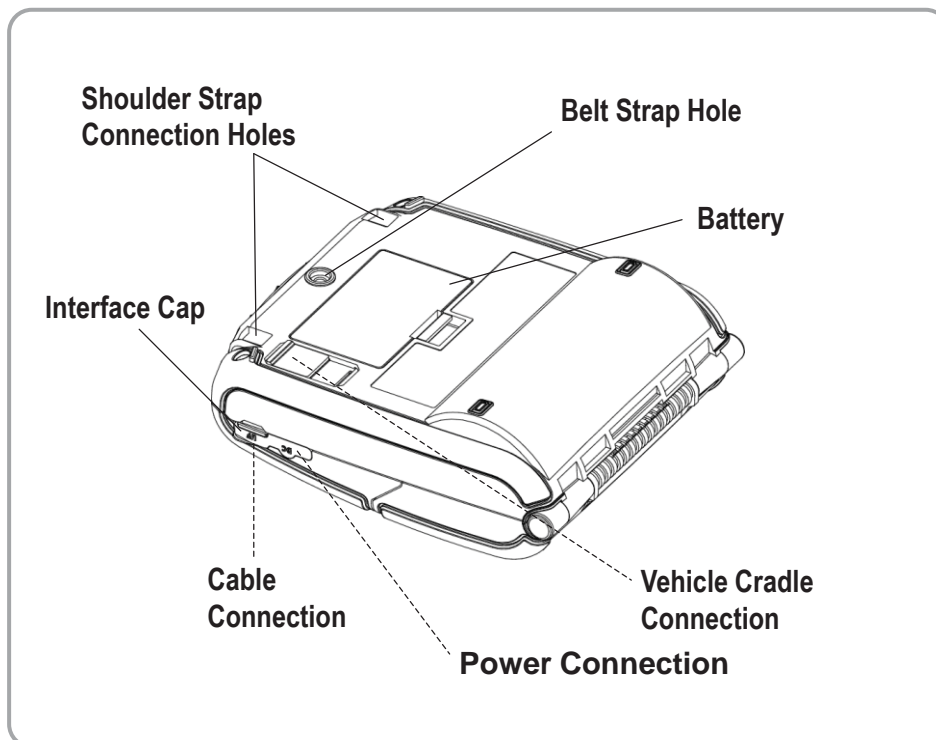

3. Installation & Usage

3-1 Battery Installation

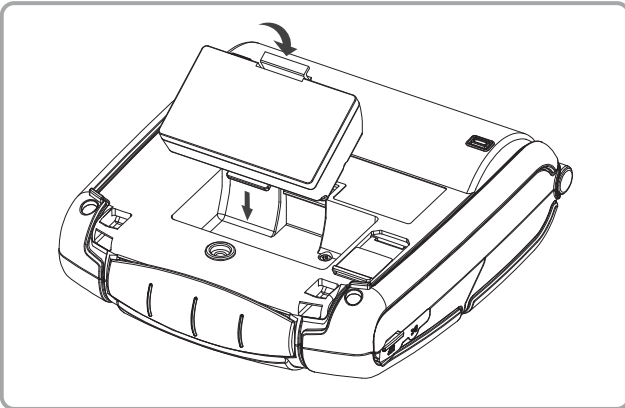

- 1) Insert the battery on the rear side of the printer, aligning the battery hook properly.
- 2) Push the battery into the slot until a snapping sound is heard.

 **NOTE**

As the battery is not charged at the time of purchase, charge the battery before use.

3-2 Battery Charging

3-2-1 Using Battery Charger

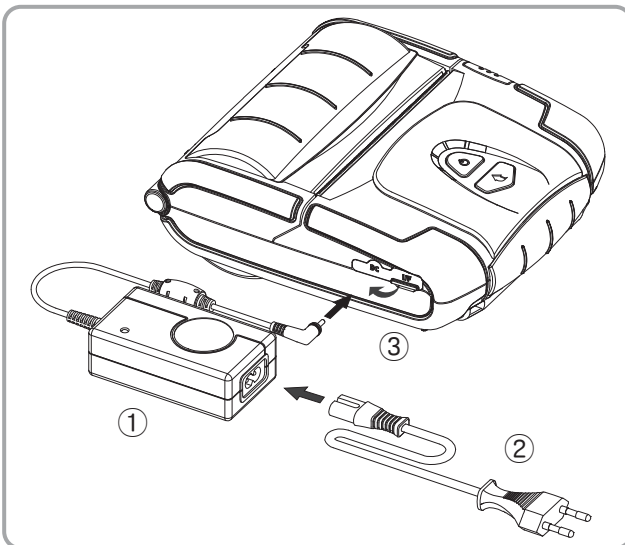

- 1) Turn off the printer power.
- 2) Connect the power cord ② to the battery charger ①, and then connect AC power.
- 3) Open the external interface cap in the direction of ③.
- 4) Connect the battery charger to the power connector.

 **CAUTION**

The printer may be seriously damaged if a battery charger not provided by BIXOLON is used. BIXOLON is not liable for such damage.

 **WARNING**

Turn off the power before charging the battery for the printer.

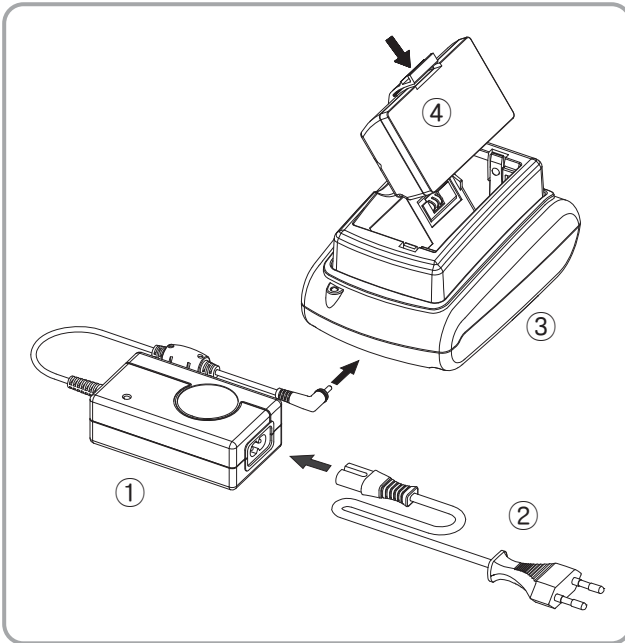
3-2-2 Using Single Battery Cradle (Optional)

- 1) Connect the power cord ② to the battery charger ①.
- 2) Connect the battery charger ① to the power connector of the single battery cradle ③.
- 3) Plug the power cord ② into an electrical outlet.
- 4) Insert the battery ④ into the battery holder ③ until a snapping sound is heard.

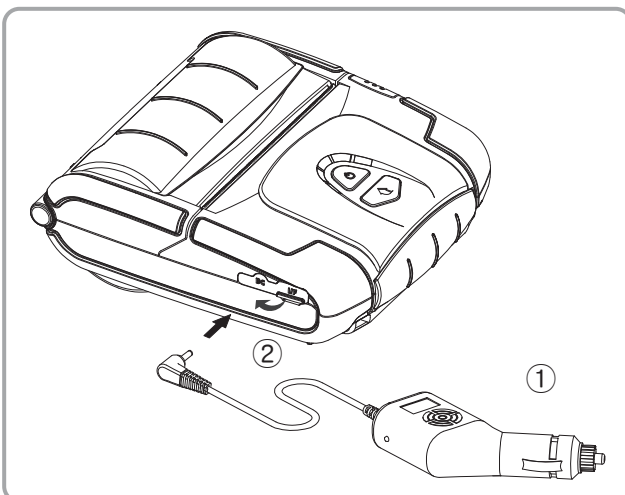
3-2-3 Using Vehicle Charger (Optional)

- 1) Turn off the power to the printer.
- 2) Connect the vehicle charger ① to your car's cigarette lighter jack.
- 3) Open the external interface protection cap in the direction of ②.
- 4) Connect the vehicle charger to the power connector.

⚠ CAUTION

The printer may be seriously damaged if a battery charger not provided by BIXOLON is used. BIXOLON is not liable for such damage.

⚠ WARNING

Turn off the power before charging the battery for the printer.

3-2-4 Using Quad Battery Charger (Optional)

3-2-4-1 Connecting the cables

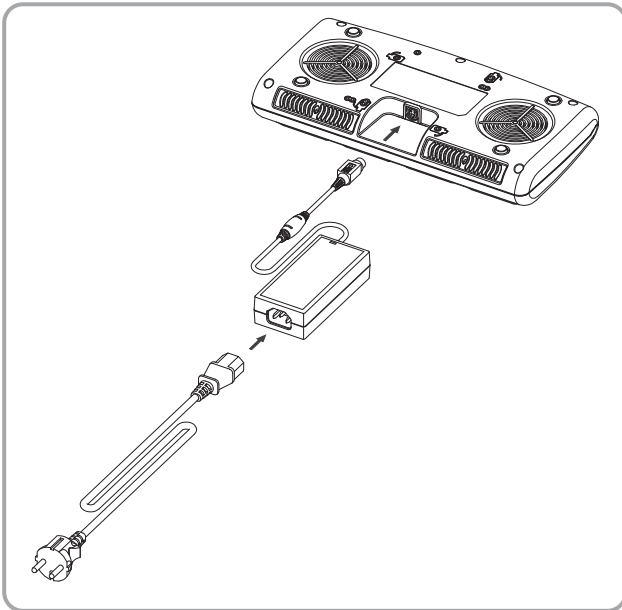

- 1) Connect the power cord to the adaptor, and Connect the adaptor to the power connector of the quad battery charger.
- 2) Plug the power cord into a power Outlet. Input power is 100 ~ 240VAC, 50/60Hz, 1.0A.
- 3) When the power is supplied, the yellow, green and red lamps are on for three seconds and do the self-test.

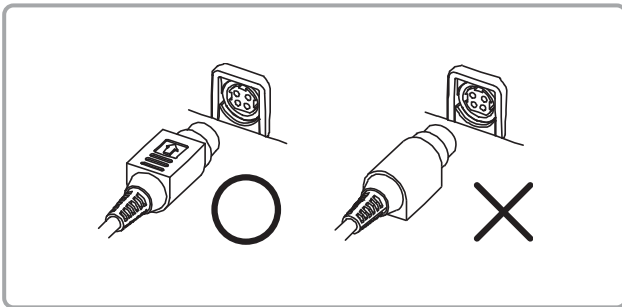

⚠ WARNING

Use only designated AC/DC adaptor.
(12VDC, 3A)

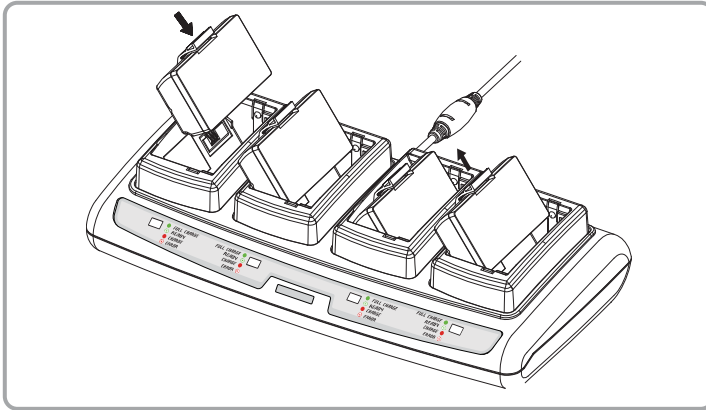
3-2-4-2 Battery Charging

- 1) Insert the battery into the quad battery charger as shown in the figure on the left.
- 2) Gently slide the battery until it reaches the bottom of the charger.
- 3) Charging starts as soon as the battery is completely inserted.
- 4) After charging, remove the battery from the quad battery charger.

 **NOTE**

Battery charging status descriptions are as follows.

Lamp	Charge Status	Charge Time
Red Lamp On	Charging	Within four hours
Green Lamp Blinking	Over 80% Charged	
Green Lamp On	Fully Charged	
Red Lamp Blinking	Error Replace or Reinstall Battery	

 **CAUTION**

1. If the red lamp of the charger blinks, install the battery again.
2. If the red lamp continues to blink despite several attempts (4 ~ 5 times) to install the battery, contact your local dealer.
3. The charging time may vary depending on the type of the charger or ambient temperature.

3-3 Paper Installation

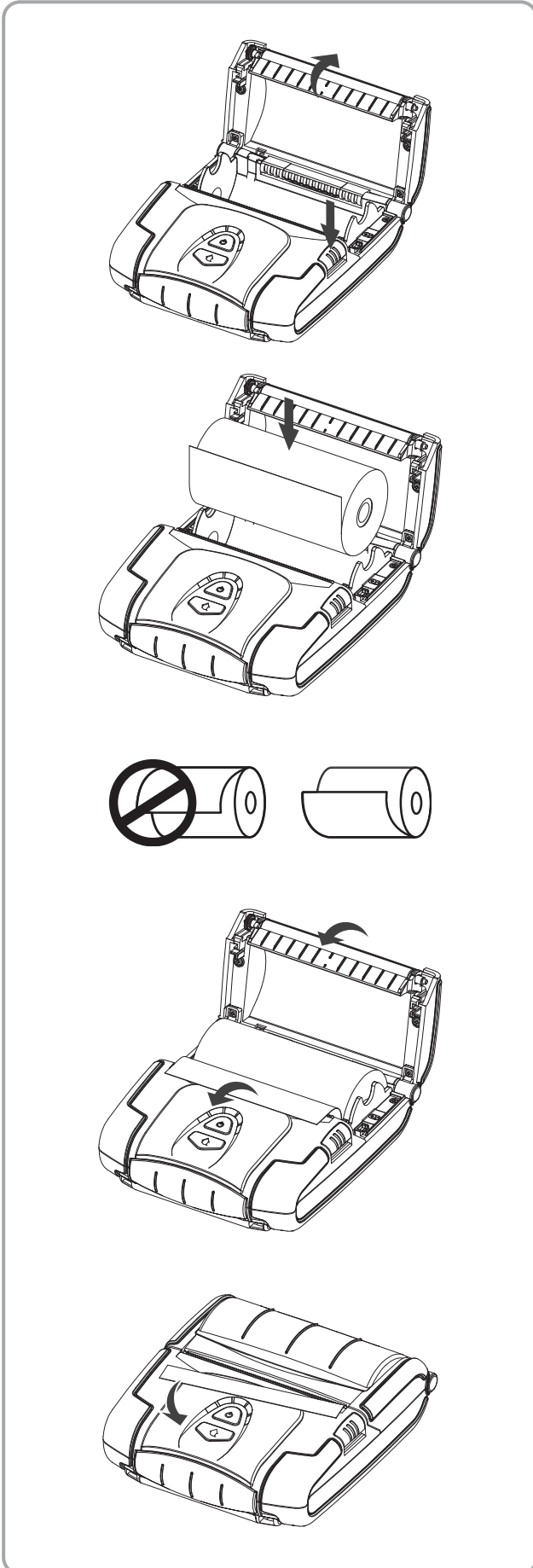

1) Press the Open button to open the paper cover.

2) Insert the paper as shown in the image. (Remove any remaining core of a fully used paper roll.)

3) Take care to align the paper correctly.

4) Pull the paper out as shown in the image and close the paper cover.

5) Tear off any excess paper in the direction of the side of the printer.

3-4 Using Belt Strap

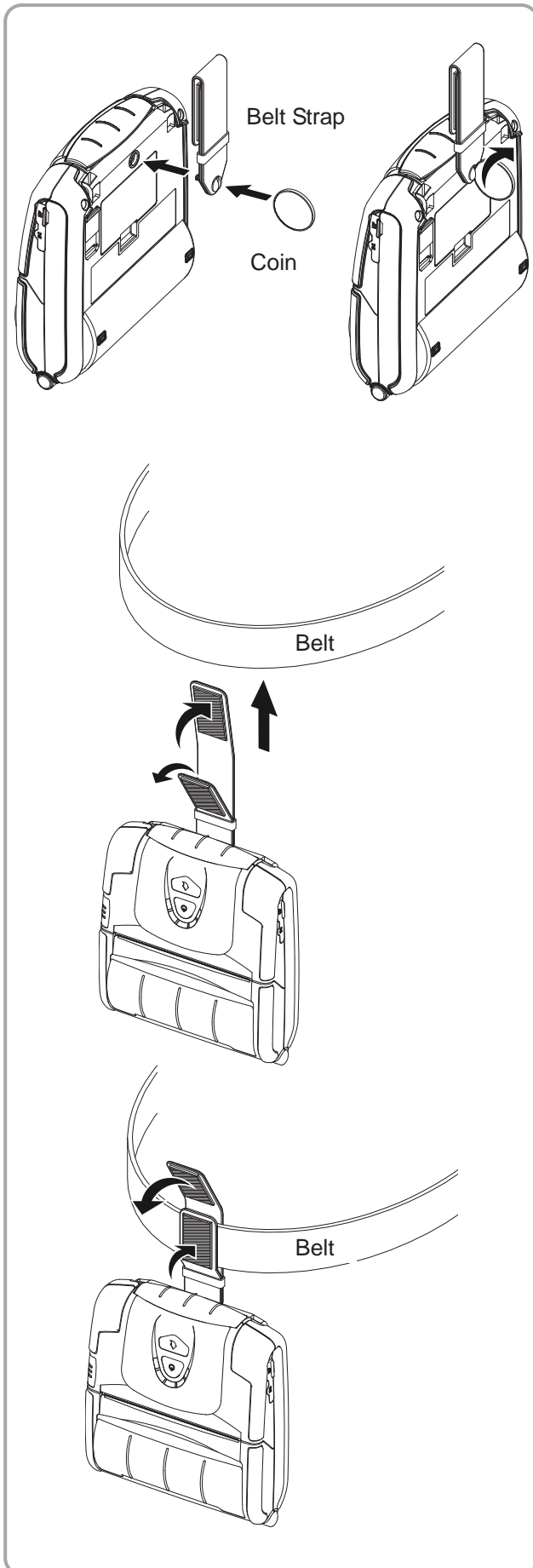

1) Insert the belt strap screw into the belt strap hole.

2) Use a coin to tighten the belt strap screw as shown in the image.

3) Undo the belt strap Velcro.

4) Fasten the belt strap to a belt.

5) Close the Velcro as shown in the image.

3-5 Using Case, Protective Case (Optional)

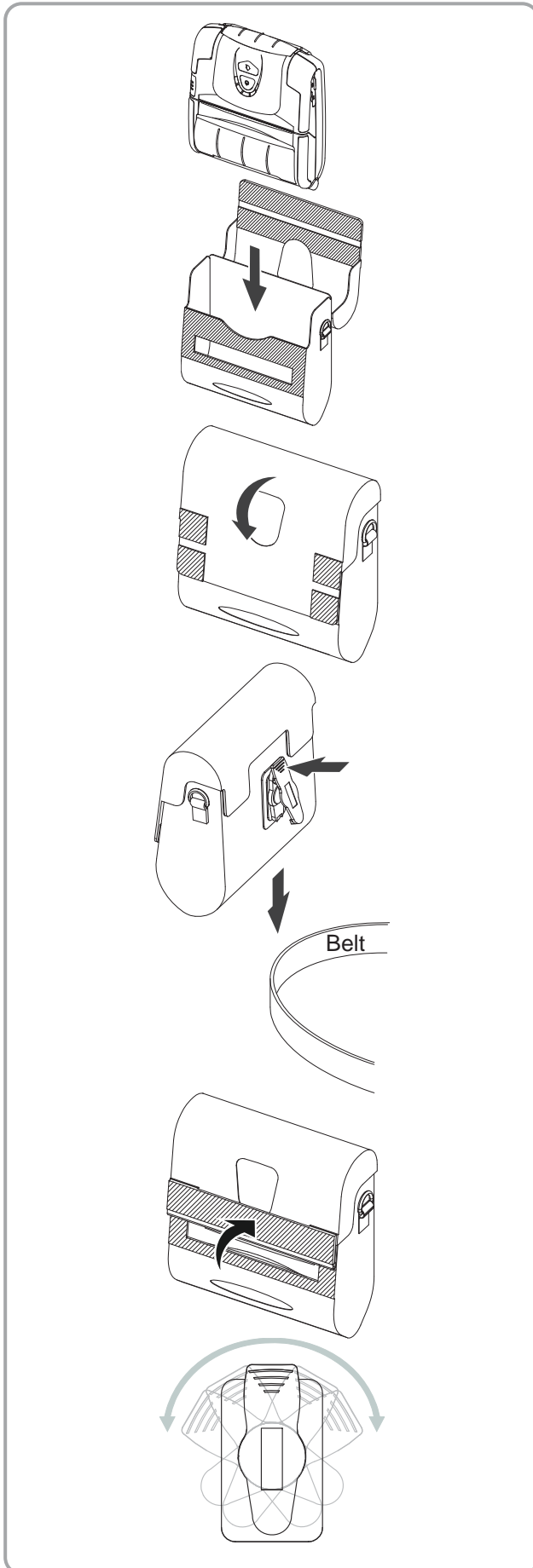

1) Open its top cover.

2) Insert your printer into the case as shown in the figure on the left.

3) Close the Velcro.

4) Attach the printer to the belt using the clip on the back of the case.

5) Open the paper discharger when using the printer as shown in the figure.

 **Note**
The clip of the case can be rotated in two steps of 30° for each step (up to 60°)

3-6 Using Shoulder Strap (Optional)

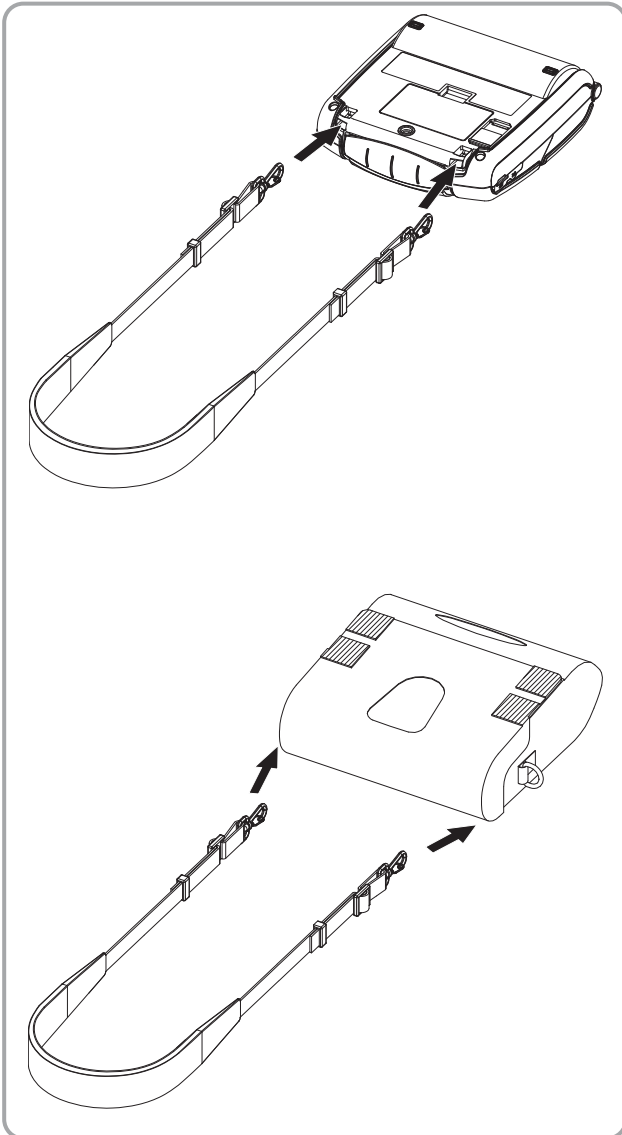

1) Connect the clips of the shoulder strap to the printer as shown in the figure on the left.

2) Connect the clips of the case as shown in the figure on the left.

3-7 Adjusting Paper Guide

112mm → 105mm

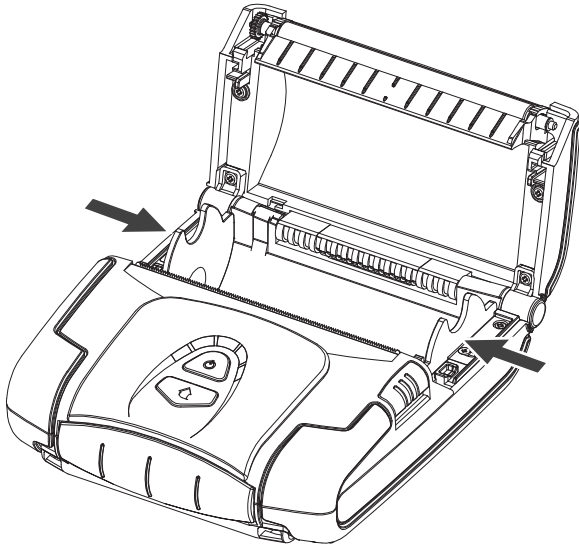

105mm → 112mm

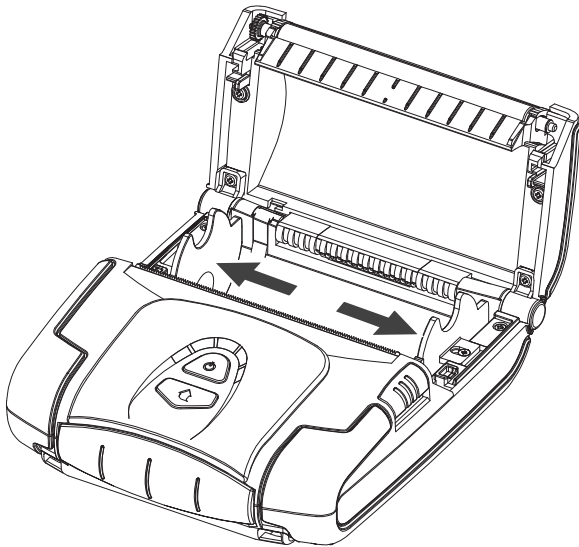

1) In order to use 105mm paper, hold the upper edge of the paper guide and adjust the paper guide for both sides in the direction of the arrow shown in the picture.

2) In order to use 112mm paper, hold the upper edge of the paper guide and adjust the paper guide for both sides in the direction of the arrow shown in the picture

3-8 Using Control Panel

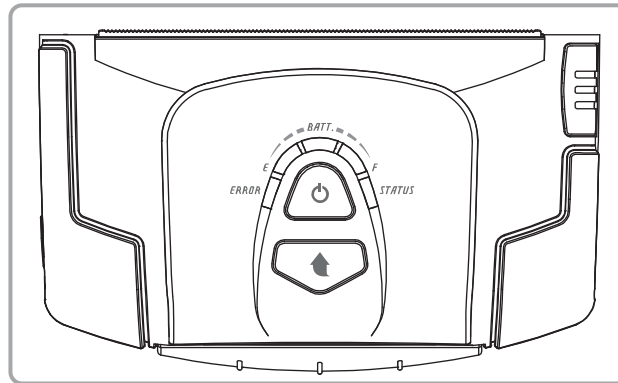

• **Power Button**

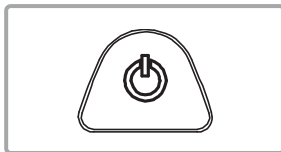

This button is used to turn the printer on/off.

- 1) To turn the printer on, press and hold the button for approximately two seconds when the printer is off.
- 2) To turn the printer off, press and hold the button for approximately two seconds when the printer is on.

• **Paper Feed Button**

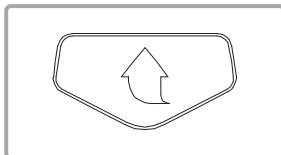

This button is used to feed paper manually, take the self-set and dump hexadecimals.

- 1) To feed paper manually, press this button.
- 2) For information on the self-test, refer to “4. Self-Test”.
- 3) For information on the dump of hexadecimals, refer to “Service Manual”.

• **Battery Status Lamp (Blue or Red)**

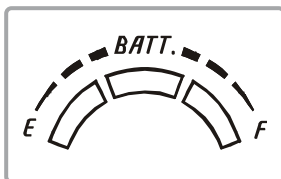

- 1) If three blue lamps are lit, the battery is fully charged.
- 2) If two blue lamps are lit, the battery is half charged.
- 3) If one blue lamp is lit, the battery is at the lowest charge level.
- 4) If the red lamp is lit, the battery must be charged or replaced.

• **Error Lamp (Left-sided)**



- 1) If the red lamp is lit, the paper cover is open.
- 2) If the red lamp is blinking, either the paper has been fully used or the print head is overheated.
(Fill with paper or turn the printer off for at least 10 minutes.)
- 3) If the red lamp continues to blink, it may indicate a more serious problem with the product, and thus an authorized service dealer should be consulted.

• **Bluetooth & Wireless LAN Lamp (Right-sided)**

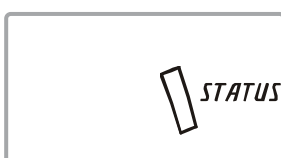

- 1) When using Bluetooth
If the printer is ready for wireless communication with any Bluetooth, the green lamp as well as the battery status lamp is turned on.
- 2) When using wireless LAN
The right indicator shows the signal strength from wireless LAN. The green lamp blinks for acceptable signal strength while the red lamp blinks for weak signal strength.
 - In power save mode, only the Status lamp is lit.

NOTE

The power saving mode is activated after the first communication, with the default time interval being 10 seconds.

3-9 Using MSR

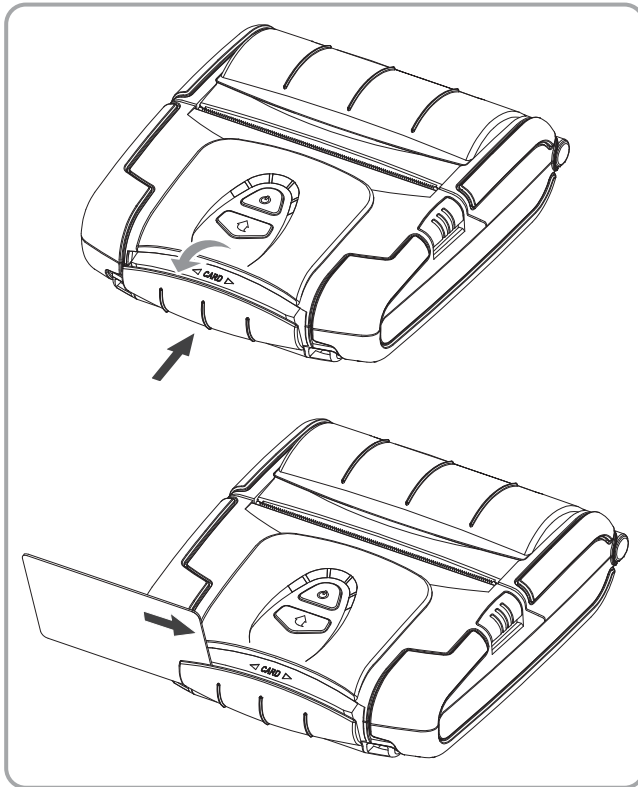

- 1) Press the MSR cover to open.
- 2) Insert the card as shown in the image and swipe in the direction of the arrow. (can be done in both directions)
- 3) When finished using, press the MSR cover to close it.

 **NOTE**

If the card does not register, first check to see if it is properly aligned. When swiping the card, the recommended swiping speed is 100 ~ 1200 mm/sec.

4. Self-Test

Run the self-test when first setting the printer or when encountering a problem, and check the following.

- Control Circuit, Mechanisms, Print Quality, ROM Version, and Memory Switch Settings

If no issue is found with the printer after running the self-test, examine the other devices or peripherals and software. This function is independent of such other devices and software.

• Self-Test Instructions

- 1) Turn the printer power off and close the printer paper cover.
- 2) Pressing the paper feed button and power button simultaneously turns the printer on.
- 3) The printout is produced after releasing the two buttons.
- 4) To add a printout of the ASCII pattern, press the paper feed button once more.
- 5) After the ASCII pattern is printed out, the self-test is automatically terminated.

5. Label Printing Function

5-1 Label Function Setting

Label paper and black mark paper available at the label mode.

- **Setting Operations**

- 1) Turn on the printer power.
- 2) Open the paper cover and press and hold down the paper feed button for longer than two seconds.
- 3) After the buzzer tone is emitted, insert paper and close the cover.
- 4) Repeat the steps above to return to receipt mode.

- **Setting Via Memory Switch**

- Please refer to the memory switch changing section of the Commands Manual.

5-2 Auto Calibration Function

The label printing function requires the recognition of label paper gaps and black mark paper black bar in order to print.

If label paper gaps are not properly recognized, use the auto calibration function.

- **Auto Calibration Instructions**

- 1) Turn the printer power off while in label print mode.
- 2) Press and hold down the paper feed button and then press the power button.
- 3) After the following printout is outputted, press the power button to perform auto calibration.

Select the mode
Auto Calibration: Power Button
Self Test: Feed Button

- 4) Three pages of label paper are outputted when performing auto calibration.

6. Peripherals Connection

This product can communicate with peripherals by using Bluetooth, wireless LAN or external interface cable (USB or serial cable).

6-1 Bluetooth & Wireless LAN Connection



- 1) The printer can be connected to devices equipped with Bluetooth communication capacity (PDAs, PCs, etc.).
- 2) Use the Bluetooth connection function supported by the device to connect to the printer.
- 3) The printer can be connected to other stations, such as PDAs and PCs supporting wireless LAN communication in Ad-hoc mode and AP in Infrastructure mode.

 **NOTE**

Refer to the Bluetooth Wireless LAN Manual for detailed information on its connection. You can check the bluetooth environment (authentication, encryption, connection mode) and the wireless LAN environment (IP, SSID, authentication, encryption) via the self-test page.

6-2 Interface Cable Connection

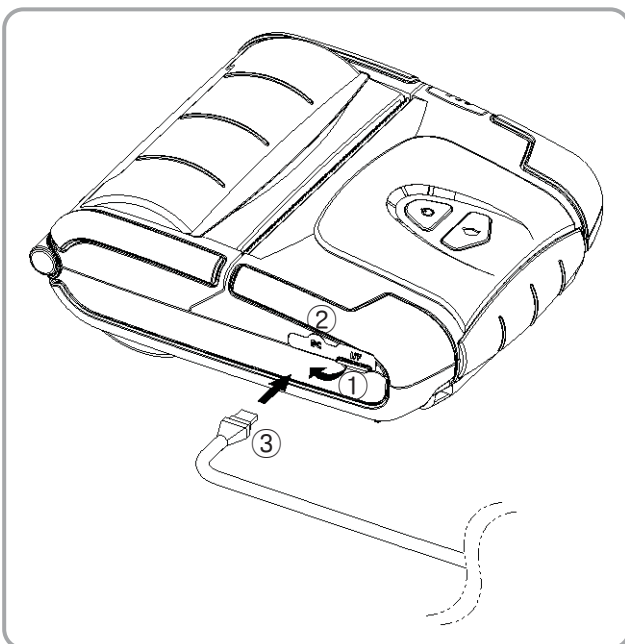

- 1) Open the external interface connector protection cap in the direction of the arrow (①).
- 2) Connect the external communication cable (option) (③) to the connector (②).

 **NOTE**

Only use USB or serial cable (option) provided by BIXOLON.

- 3) Connect the interface cable to the USB port of the device (PDAs, PCs, etc.).

 **NOTE**

The interface cable that can be connected with the printer is available in both USB and Serial type.

Refer to the service manual for detailed interface cable specifications.

7. Printer Cleaning

If the interior of the printer is dusty, print quality can decline.
In such a case, follow the instructions below to clean the printer.

⚠ CAUTION

- Make sure to turn the printer power off prior to cleaning.
- As the print head gets very hot during printing, if intending to clean the print head, turn the printer power off and wait approximately 10 minute before commencement.
- When cleaning the print head, take care not to touch the heated portion of the print head.
→ The print head is susceptible to damage from static electricity, etc.
- Take care not to allow the print head to become scratched and/or damaged in any way.



- 1) Open the paper cover and remove any paper that may be present.
- 2) Wipe the print head with a cleaning pen.
- 3) Use a cloth moistened with an alcohol solution to clean the paper sensor area and remove any paper remnants and/or dust.
- 4) Insert paper into the printer 1~2 minutes after completing the cleaning process and close the printer cover.

8. Appendix

8-1 Specifications

Item	Description	
Printing	Printing Method	Thermal printing
	Printing Speed	80 mm/sec
	Resolution	203 DPI
	Paper Supply Mode	Easy paper loading
	Character Size	Font A: 12 x 24 Font B: 9 x 17 Font C: 9 x 24
	Characters Per Line	Font A: 48 Font B/C: 64
	Character Set	English: 95 Expanded Graphics: Standard(ENG) -128 x 33 pages Others(KOR,CHN,JPN) - 128 x 20 pages International: 32
	Barcode	1 Dimension: UPC A, UPC E, CODE 39, CODE 93, Code 128, EAN 8, EAN 13, ITF, Codabar 2 Dimension: PDF417, DATAMATRIX, MAXI, QR Code
	Emulation	BXL/POS
	Driver	Windows XP / WEPOS / 2003 Server / VISTA / 2008 Server / 7 / 8
	SDK	Windows XP / WEPOS / 2003 Server / VISTA / 2008 Server / 7 / 8 / Windows CE 5.0 and later
	Sensor	Paper End, Paper Cover Open Switch, Front/Rear Black Mark
	Cutter Type	Tear-Bar
	Language	User language supported
Paper	Paper Type	Thermal paper
	Width	104.5 ± 0.5 mm (4.11" ± 0.2") 111.5 ± 0.5 mm (4.39" ± 0.2")
	Diameter	Max. ø57 mm (2.24")
	Thickness	0.07 ± 0.003 mm
Reliability	TPH	50 km
	Battery	Rechargeable up to 300 times
Communications	Interface	Serial/USB, Bluetooth Class2 V2.0 +EDR, Wireless LAN 802.11 b/g * Communication is enabled only for devices with Bluetooth or Wireless LAN function.
Battery Charger	Input	Voltage: 100 ~ 250 VAC Current: 0.5A (Max. at 110VA)
	Output	Voltage: 8.4 VDC Current: 0.8A * The charging current and the charging time may vary depending on the type of charger (option).
Battery	Cell	Lithium-ion
	Voltage	7.2 V, 7.4 V
	Charging Capacity	2600mAh
	Charging Time	Within four hours
Usage Conditions	Temperature	-15~50°C (5~122°F)
	Humidity	10~80% RH (No condensation)
Dimensions	Printer	147mm x 171.4mm x 66.7mm (5.79" x 6.75" x 2.63")
Weight	Printer	Printer: 595g (1.31lbs) Printer + Battery: 697g (1.54lbs) Printer + Battery + Paper: 939g (2.07lbs) Shipping Package: Approximately 1530g (3.37lbs)
Accessories	Basic Package	Battery Pack, Battery charger, Belt strap, Paper
	Sold Separately	Shoulder Strap, Case, Protective Case, Battery Pack, Single Battery Cradle, Quad Battery Charger, Vehicle Charger, Interface Cable, Cleaning Pen

8-2 Certification

1) WEEE (Waste Electrical and Electric Equipment)



This mark shown on the product or its literature indicates that the corresponding item should not be discarded at the end of its working life with other household waste. To prevent possible harm to the environment or human health from uncontrolled waste disposal, please separate marked items from other types of waste and recycle them responsibly to promote the sustained reuse of material resources. Household users should contact either the retailer where they purchased this product, or their local government office for details of where and how they can conduct environmentally safe recycling of such items. Commercial users should contact their suppliers and check the terms and conditions of purchase contracts. This product should not be combined with other commercial waste for disposal.

2) Rating Label Symbol Information



■ ■ ■ DC (Direct current)

3) This equipment is indooruse and all the communication hiring are limited to inside of the building.

4) The switch is the disconnecting device. Turn off switch from any hazard.

5) The following Bluetooth mark and QD ID B019948 is only applicable to models with the Bluetooth SIG qualification.



Warning

Lithium-Ion Battery pack

<Warning> The battery has the potential risk of overheating, fire and/or explosion. To avoid such risks, observe the following instructions:

- A visibly swollen battery may be dangerous. Contact BIXOLON or your local dealer.
- Only use an eligible charger.
- Keep away from open flames. (Do not place in a microwave.)
- Do not leave the battery pack inside a vehicle in summertime.
- Do not store or use in a hot and humid place like a sauna with sleeping rooms.
- Do not place the battery pack on a quilt, an electric blanket or a carpet for a long time.
- Do not store the battery pack switched on in an enclosed place for a long time.
- Do not allow the battery port to touch metal items, such as necklace, coin, key or clock etc.
- Use the lithium secondary cell guaranteed by mobile phone manufacturer or BIXOLON.
- Do not disassemble, compress or pierce the battery pack.
- Do not drop the battery pack from a high place or subject it to strong shock.
- Do not expose the battery to high temperatures over 60°C.
- Do not expose to humidity.

Disposal Directions

- Do not dispose of waste battery packs recklessly.
- Do not burn or throw in fire to dispose of the battery pack.
There is a risk of fire and/or explosion.
- How to dispose of battery packs may vary depending on countries or regions.
Dispose of it in the correct method.

Recommendation for Charging

- Do not charge your battery pack in a way not mentioned in the instruction manual.
Doing so may result in fire or explosion.

FCC compliance Information

This device complies with part 15 of FCC Rules. Operation is subject to the following two conditions: (1) This device may not cause harmful interference, and (2) This device must accept any interference received, including interference that may cause undesired operation.

Information to the user

NOTE: This equipment has been tested and found to comply with the limits for a Class B digital device, pursuant to part 15 of the FCC Rules.

These limits are designed to provide reasonable protection against harmful interference in a residential installation.

This equipment generates, uses and can radiate radio frequency energy and, if not installed and used in accordance with the instructions, may cause harmful interference to radio communications. However, there is no guarantee that interference will not occur in a particular installation. If this equipment does cause harmful interference to radio or television reception, which can be determined by turning the equipment off and on, the user is encouraged to try to correct the interference by one or more of the following measures:

- Reorient or relocate the receiving antenna.
- Increase the separation between the equipment and receiver.
- Connect the equipment into an outlet on a circuit different from that to which the receiver is connected.
- Consult the dealer or an experienced radio/TV technician for help.

This device is not intended for use in the direct field of view at visual display workplace. To avoid incommoding reflexions at visual display workplaces this device must not be placed in the direct field of view

8-3 Label Types

The labels used on this product are composed of the following materials;

- BIXOLON logo label: PC
- Rating Label: PP
- Other labels: PET