

DATALOGIC

Heron™ HD3130

Linear Imager



Product Reference Guide

Datalogic ADC, Inc.

959 Terry Street
Eugene, OR 97402
USA

Telephone: (541) 683-5700

Fax: (541) 345-7140

©2015 Datalogic ADC, Inc.

An Unpublished Work - All rights reserved. No part of the contents of this documentation or the procedures described therein may be reproduced or transmitted in any form or by any means without prior written permission of Datalogic ADC, Inc. or its subsidiaries or affiliates ("Datalogic" or 'Datalogic ADC"). Owners of Datalogic products are hereby granted a non-exclusive, revocable license to reproduce and transmit this documentation for the purchaser's own internal business purposes. Purchaser shall not remove or alter any proprietary notices, including copyright notices, contained in this documentation and shall ensure that all notices appear on any reproductions of the documentation.

Should future revisions of this manual be published, you can acquire printed versions by contacting your Datalogic representative. Electronic versions may either be downloadable from the Datalogic website (www.datalogic.com) or provided on appropriate media. If you visit our website and would like to make comments or suggestions about this or other Datalogic publications, please let us know via the "Contact Datalogic" page.

Disclaimer

Datalogic has taken reasonable measures to provide information in this manual that is complete and accurate, however, Datalogic reserves the right to change any specification at any time without prior notice.

Datalogic and the Datalogic logo are registered trademarks of Datalogic S.p.A. in many countries, including the U.S.A. and the E.U. All other brand and product names may be trademarks of their respective owners.

Patents

See www.patents.datalogic.com for patent list.



Table of Contents

INTRODUCTION	1
About the Scanner	1
Using the Heron Reader	1
About this Manual	2
Overview	2
Manual Conventions	3
Technical Support	3
Datalogic Website Support	3
Reseller Technical Support	3
Telephone Technical Support	3
SETUP	5
Unpacking	5
Setting Up the Scanner	5
Connect Host Interface	6
Stand Installation	8
Using as a Hands-Free Stand	9
Interface Selection	11
Configuring the Interface	11
Customizing Configuration Settings	14
Using the Programming Bar Codes	14
Interface Settings	15
Configuring Other Features	15
Software Version Transmission	15
CONFIGURATION USING BAR CODES	17
Configuration Parameters	17
Global Interface Features	19
Host Commands — Obey/Ignore	19
USB Suspend Mode	20
RS-232 ONLY INTERFACE 21	
RS-232 Standard Factory Settings	21
Baud Rate	21
Stop Bits	22
Parity	23
Handshaking Control	24
RS-232/USB-COM INTERFACES 25	
Standard Factory Settings	25
Intercharacter Delay	26
Beep On ASCII BEL	27
Beep On Not on File	27
ACK NAK Options	28
ACK Character	29
NAK Character	29
ACK NAK Timeout Value	30
ACK NAK Retry Count	31
ACK NAK Error Handling	32
Indicate Transmission Failure	33
Disable Character	33
Enable Character	34
KEYBOARD INTERFACE 35	
Country Mode	36
Caps Lock State	39
Numlock	39

Keyboard Numeric Keypad	40
Keyboard Send Control Characters	41
Wedge Quiet Interval	42
Intercharacter Delay	43
Intercode Delay	44
USB Keyboard Speed	45
USB-OEM INTERFACE 47	
Introduction	47
Standard Factory Settings	47
USB-OEM Device Usage	48
USB-OEM Interface Options	48
DATA FORMAT 49	
Global Prefix/Suffix	50
Global AIM ID	51
GS1-128 AIM ID	51
Label ID	52
Label ID: Pre-loaded Sets	52
Label ID: Set Individually Per Symbology	53
Label ID Control	53
Label ID Symbology Selection	54
Case Conversion	60
Character Conversion	60
READING PARAMETERS 61	
Double Read Timeout	62
Label Gone Timeout	64
LED and Speaker Indicators	65
Power On Alert	65
Audio Jingles	65
Audio Jingle Enable	66
Select Audio Jingle for Power-up Event	67
Select Audio Jingle for Good Read Event	68
Select Audio Jingle for Enter Stand Mode	69
Select Audio Jingle for Exit Stand Mode	70
Select Audio Jingle for Transmit Error Sound	71
Good Read: When to Indicate	72
Good Read Beep Type	73
Good Read Beep Frequency	73
Good Read Speaker Volume	74
Good Read Beep Length	75
RGB LED Settings	76
Enable/Disable RGB LED	76
Good Read LED Color	77
RGB Good Read Raising Time	77
RGB Good Read Falling Time	78
RGB Good Read Holding Time	78
RGB Auto Delay	79
Scanning Features	80
Scan Mode	80
Stand Mode Triggered Timeout	81
Scanning Active Time	82
Stand Mode Flash	83
Flash On Time	83
Flash Off Time	84
Stand Mode Sensitivity	84
SYMBOLOGIES 85	
Introduction	85
Standard Factory Settings for Symbologies	85
Disable All Symbologies	86
Coupon Control	86
UPC-A	87
UPC-A Enable/Disable	87
UPC-A Check Character Transmission	87

Expand UPC-A to EAN-13	88
UPC-A Number System Character Transmission	88
In-Store Minimum Reads	89
UPC-E	90
UPC-E Enable/Disable	90
UPC-E Check Character Transmission	90
Expand UPC-E to EAN-13	91
Expand UPC-E to UPC-A	91
UPC-E Number System Character Transmission	92
UPC-E Minimum Read	92
EAN 13	93
EAN 13 Enable/Disable	93
EAN 13 Check Character Transmission	93
EAN-13 Flag 1 Character	94
EAN-13 ISBN Conversion	94
ISSN Enable/Disable	95
EAN 13 Minimum Reads	95
EAN 8	96
EAN 8 Enable/Disable	96
EAN 8 Check Character Transmission	96
Expand EAN 8 to EAN 13	97
EAN 8 Minimum Reads	97
UPC/EAN Global Settings	98
UPC/EAN Decoding Level	98
UPC/EAN Price Weight Check	99
UPC-A Minimum Reads	100
Add-Ons	101
Optional Add-ons	101
Optional Add-On Timer	102
P2 Add-Ons Minimum Reads	103
P5 Add-Ons Minimum Reads	104
GS1 DataBar™ Omnidirectional	105
GS1 DataBar Omnidirectional Enable/Disable	105
GS1 DataBar Omnidirectional GS1-128 Emulation	105
GS1 DataBar Omnidirectional Minimum Reads	106
GS1 DataBar™ Expanded	107
GS1 DataBar Expanded Enable/Disable	107
GS1 DataBar Expanded GS1-128 Emulation	107
GS1 DataBar Expanded Minimum Reads	108
GS1 DataBar Expanded Length Control	109
GS1 DataBar Expanded Set Length 1	109
GS1 DataBar Expanded Set Length 2	110
GS1 DataBar™ Limited	111
GS1 DataBar Limited Enable/Disable	111
GS1 DataBar Limited GS1-128 Emulation	111
GS1 DataBar Limited Minimum Reads	112
Code 39	113
Code 39 Enable/Disable	113
Code 39 Check Character Calculation	114
Code 39 Check Character Transmission	115
Code 39 Start/Stop Character Transmission	115
Code 39 Full ASCII	116
Code 39 Quiet Zones	117
Code 39 Minimum Reads	118
Code 39 Decoding Level	119
Code 39 Length Control	120
Code 39 Set Length 1	121
Code 39 Set Length 2	122
Code 39 Interdigit Ratio	123
Code 39 Stitching	125
Code 32 (Italian Pharmaceutical)	125
Code 32 Enable/Disable	125

Code 32 Feature Setting Exceptions	126
Code 32 Check Character Transmission	126
Code 32 Start/Stop Character Transmission	126
Code 39 CIP (French Pharmaceutical)	127
Code 39 CIP Enable/Disable	127
Code 128	127
Code 128 Enable/Disable	127
Expand Code 128 to Code 39	128
Code 128 Check Character Transmission	128
Code 128 Function Character Transmission	129
Code 128 Sub-Code Change Transmission	129
Code 128 Quiet Zones	130
Code 128 Minimum Reads	131
Code 128 Decoding Level	132
Code 128 Length Control	133
Code 128 Set Length 1	134
Code 128 Set Length 2	135
Code 128 Stitching	135
GS1-128	136
GS1-128 Enable	136
Interleaved 2 of 5 (I 2 of 5)	137
I 2 of 5 Enable/Disable	137
I 2 of 5 Check Character Calculation	138
I 2 of 5 Check Character Transmission	139
I 2 of 5 Minimum Reads	140
I 2 of 5 Decoding Level	141
I 2 of 5 Length Control	142
I 2 of 5 Set Length 1	143
I 2 of 5 Set Length 2	144
I 2 of 5 Zero Pattern	144
Interleaved 2 of 5 CIP HR	145
Interleaved 2 of 5 CIP HR Enable/Disable	145
Datalogic 2 of 5	146
Datalogic 2 of 5 Enable/Disable	146
Datalogic 2 of 5 Check Character Calculation	146
Datalogic 2 of 5 Check Character Transmission	147
Datalogic 2 of 5 Minimum Reads	147
Datalogic 2 of 5 Decoding Level	148
Datalogic 2 of 5 Length Control	148
Datalogic 2 of 5 Set Length 1	149
Datalogic 2 of 5 Set Length 2	150
Datalogic 2 of 5 Interdigit Ratio	151
Codabar	153
Codabar Enable/Disable	153
Codabar Check Character Calculation	153
Codabar Check Character Transmission	154
Codabar Start/Stop Character Transmission	154
Codabar Start/Stop Character Set	155
Codabar Start/Stop Character Match	155
Codabar Quiet Zones	156
Codabar Minimum Reads	157
Codabar Decoding Level	158
Codabar Length Control	159
Codabar Set Length 1	160
Codabar Set Length 2	161
Codabar Interdigit Ratio	162
ABC Codabar	164
ABC Codabar Enable/Disable	164
ABC Codabar Concatenation Mode	164
ABC Codabar Dynamic Concatenation Timeout	165
ABC Codabar Force Concatenation	165
Code 11	166

Code 11 Enable/Disable	166
Code 11 Check Character Calculation	167
Code 11 Check Character Transmission	167
Code 11 Minimum Reads	168
Code 11 Length Control	169
Code 11 Set Length 1	169
Code 11 Set Length 2	170
Code 11 Interdigit Ratio	171
Code 11 Decoding Level	173
Standard 2 of 5	174
Standard 2 of 5 Enable/Disable	174
Standard 2 of 5 Check Character Calculation	174
Standard 2 of 5 Check Character Transmission	175
Standard 2 of 5 Minimum Reads	175
Standard 2 of 5 Decoding Level	176
Standard 2 of 5 Length Control	176
Standard 2 of 5 Set Length 1	177
Standard 2 of 5 Set Length 2	178
Industrial 2 of 5	179
Industrial 2 of 5 Enable/Disable	179
Industrial 2 of 5 Check Character Calculation	179
Industrial 2 of 5 Check Character Transmission	180
Industrial 2 of 5 Length Control	180
Industrial 2 of 5 Set Length 1	181
Industrial 2 of 5 Set Length 2	182
Industrial 2 of 5 Minimum Reads	183
IATA	184
IATA Enable/Disable	184
IATA Check Character Transmission	184
ISBT 128	185
ISBT 128 Concatenation	185
ISBT 128 Concatenation Mode	185
ISBT 128 Dynamic Concatenation Timeout	186
ISBT 128 Force Concatenation	187
ISBT 128 Advanced Concatenation Options	187
MSI	188
MSI Enable/Disable	188
MSI Check Character Calculation	188
MSI Check Character Transmission	189
MSI Length Control	189
MSI Set Length 1	190
MSI Set Length 2	191
MSI Minimum Reads	192
MSI Decoding Level	193
Code 93	194
Code 93 Enable/Disable	194
Code 93 Check Character Calculation	194
Code 93 Check Character Transmission	195
Code 93 Length Control	195
Code 93 Set Length 1	197
Code 93 Set Length 2	198
Code 93 Minimum Reads	199
Code 93 Decoding Level	200
Code 93 Quiet Zones	201
Codablock F	202
Codablock F Enable/Disable	202
Codablock F EAN Enable/Disable	202
Codablock F AIM Check	203
Codablock F Length Control	203
Codablock F Set Length 1	204
Codablock F Set Length 2	205
Code 4	206

Code 4 Enable/Disable	206
Code 4 Check Character Transmission	206
Code 4 Hex to Decimal Conversion	207
Code 5	207
Code 5 Enable/Disable	207
Code 5 Check Character Transmission	208
Code 5 Hex to Decimal Conversion	208
Code 4 and Code 5 Common Configuration Items	209
Code 4 and 5 Decoding Level	209
Code 4 and Code 5 Minimum Reads	210
Follett 2 of 5	211
Follett 2 of 5 Enable/Disable	211
BC412	211
BC412 Enable/Disable	211
BC412 Check Character Calculation	212
BC412 Minimum Reads	212
BC412 Decoding Level	213
BC412 Length Control	214
BC412 Set Length 1	214
BC412 Set Length 2	215
REFERENCES.....	217
RS-232 Parameters	218
RS-232 Only	218
RS-232/USB COM Parameters	219
Keyboard Interface	226
Wedge Quiet Interval	226
Intercharacter Delay	227
Intercode Delay	228
Data Format	229
Data Editing	229
Global Prefix/Suffix	230
Global AIM ID	231
Label ID	232
Character Conversion	236
Reading Parameters	237
Label Gone Timeout	237
RGB LED Features	238
Scanning Features	241
Scan Mode	241
Scanning Active Time	242
Flash On Time	243
Flash Off Time	244
Symbologies	245
Decoding Levels	245
Set Length	245
TECHNICAL SPECIFICATIONS.....	249
LED and Beeper Indications	251
Programming Mode	252
Troubleshooting	252
Error Codes	253
Standard Cable Pinouts	254
Stand Dimensions	255
Stand Base Plate Template	256
STANDARD DEFAULTS.....	257
Default Exceptions	268
SAMPLE BAR CODES	271
1D Bar Codes	271
GS1 DataBar (RSS)	273
GS1 DataBar-14	273

KEYPAD.....	275
SCANCODE TABLES.....	279
Control Character Emulation	279
Single Press and Release Keys	279
Interface Type PC AT PS/2 or USB-Keyboard	280
Interface Type PC AT PS/2 Alt Mode or USB-Keyboard Alt Mode	282
Microsoft Windows Codepage 1252	284
Index	285

NOTES



Chapter 1

Introduction

About the Scanner

Bridging the gap between man and machine, the Heron™ HD3130 linear imager brings high style along with technology to the modern point of sale. Distinctive features such as side and top lights, polyphonic speaker and stylish top covers, as well as Green Spot technology, characterize this innovative reader.

Perfect for use as both a handheld and a presentation style reader, the Heron imager is lightweight and ergonomically shaped for handheld use and includes an auto-sensing stand in the package.

Developed to satisfy the most demanding reading requirements for linear reading at POS checkout, the Heron linear imager is available as an all-in-one multi-interface solution (RS-232, USB and Wedge).

The Heron™ HD3130 Linear Imager has several new features. See "[Reading Parameters](#)" on page 61 for information on setting these features:

- The reader's attractive illumination (top and sides) selectively changes color to indicate its status.
- The user has the option to use personal jingles (a short user-defined tune uploaded via Datalogic Aladdin™ configuration software) instead of the normal beep tone.

Using the Heron Reader

Heron readers automatically scan barcodes at a distance. Simply aim and pull the trigger. Code scanning is performed along the center of the light bar emitted from the reading window. This bar must cover the entire code.

Effective scanning is obtained by tilting the scanner with respect to the barcode to avoid direct reflections, which impair the reading performance (see Figure 1A below). A successful read is signaled by an audible tone or a jingle (previously uploaded), plus a good-read green spot. The side and upper illuminators become green (unless another color has been configured with Datalogic Aladdin™ configurator).

Once the reader is correctly inserted into the stand, it is immediately ready to automatically read any code present in its reading area without pressing the trigger. Furthermore, a green aiming light (Datalogic's patented 'Green Spot') is continuously emitted to facilitate the positioning of the bar code to be read (shown in Figure 1B).

To guarantee single code reading, consecutive reading of the same code requires the code to be removed from the reading area (no decoding) before the reader will accept the same code again.

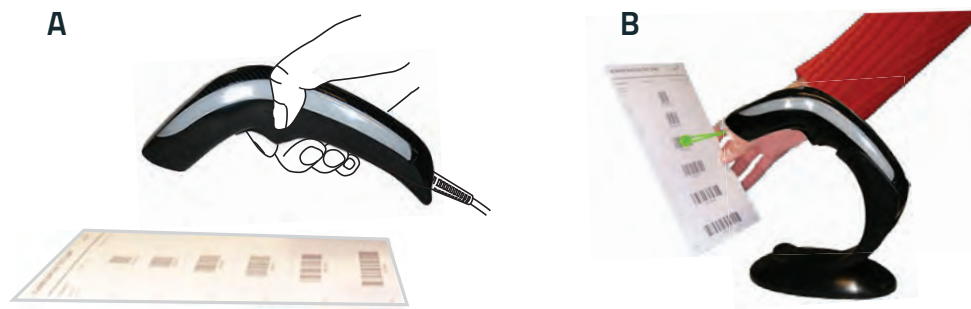
Figure 1. Correct positioning of scanner

About this Manual

This Product Reference Guide (PRG) is provided for users seeking advanced technical information, including connection, programming, maintenance and specifications. The Quick Reference Guide (QRG) and other publications associated with this product are downloadable free of charge from the website listed on the back cover of this manual.

Typically, units are factory-programmed for the most common terminal and communications settings. If you need to modify any programmable settings, custom configuration can be accomplished by scanning the programming bar codes within this guide.

Programming can alternatively be performed using the Datalogic Aladdin™ Configuration application, which is available from the Datalogic website listed on the back cover of this manual. This multi-platform utility program allows device configuration using a PC. It communicates to the device using a serial or USB cable and can also create configuration bar codes to print.

Overview

[Chapter 1, Introduction](#) provides a product overview, unpacking instructions, and cable connection information.

[Chapter 2, Setup](#) presents information about unpacking and setting up the scanner, and interface configuration bar codes and details.

[Chapter 3, Configuration Using Bar Codes](#) provides instructions and bar code labels for customizing your scanner. There are different sections for interface types, general features, data formatting, and symbology-specific features.

[Chapter 4, References](#) provides details concerning programmable features.

[Appendix A, Technical Specifications](#) lists physical and performance characteristics, as well as environmental and regulatory specifications. It also provides standard cable pin-outs and descriptions of the functions and behaviors of the scanner's LED and Speaker indicators.

[Appendix B, Standard Defaults](#) references common factory default settings for scanner features and options.

[Appendix C, Sample Bar Codes](#) offers sample bar codes of several common symbologies.

[Appendix D, Keypad](#) includes numeric bar codes to be scanned for certain parameter settings.

[Appendix E, Scancode Tables](#) lists control character emulation information for Wedge and USB Keyboard interfaces.

Manual Conventions

The symbols listed below are used in this manual to notify the reader of key issues or procedures that must be observed when using the scanner:



NOTE

Notes contain information necessary for properly diagnosing, repairing and operating the scanner.



CAUTION

The CAUTION symbol advises you of actions that could damage equipment or property.

Technical Support

Datalogic Website Support

The Datalogic website (www.datalogic.com) is the complete source for technical support and information for Datalogic products. The site offers product support, warranty information, product manuals, product tech notes, software updates, demos, and instructions for returning products for repair.

Reseller Technical Support

An excellent source for technical assistance and information is an authorized Datalogic reseller. A reseller is acquainted with specific types of businesses, application software, and computer systems and can provide individualized assistance.

Telephone Technical Support

If you do not have internet or email access, you may contact Datalogic technical support at (541) 349-8283 or check the back cover of your manual for more contact information.

Current versions of the Product Reference Guide (PRG), Quick Reference Guide (QRG), the Datalogic Aladdin™ Configuration application, software/firmware and any additional manuals, instruction sheets and utilities for this product can be downloaded from the website listed on the back cover of this manual. Alternatively, printed copies or product support CDs may be purchased through your Datalogic reseller.

NOTES



Chapter 2 Setup

Unpacking

Check carefully to ensure the scanner and any cables or accessories ordered are present and undamaged. If any damage occurred during shipment, contact Technical Support on page 3.

KEEP THE PACKAGING. Should the unit ever require service, it should be returned in its original shipping container.

Setting Up the Scanner

Follow the steps provided in this section to connect and get your scanner up and communicating with its host:

1. Connect the Interface Cable at the scanner as shown in Figure 2. To disconnect the cable, insert a paper clip or similar object into the opening shown (item #3).
2. Connect the other end to the Host (see the next section, [Connect Host Interface on page 6](#) and Figure 3).
3. Modify "[Customizing Configuration Settings](#)" on page 14 (only if modifications are needed from factory settings).

Figure 2. Cable Connection/Disconnection at the Scanner



Connect Host Interface

The scanner kit you ordered to match your interface should provide a compatible cable for your installation. If this is not so, contact [Technical Support](#).

The scanner can communicate using the following interfaces:

RS-232 Serial Connection

Turn off power to the terminal/PC and connect the scanner to the terminal/PC serial port via the RS-232 cable as shown in Figure 3. If the terminal will not support POT (Power Off the Terminal) to supply scanner power, use the approved power supply (AC Adapter). Plug the AC Adapter barrel connector into the socket on the RS-232 cable connector and the AC Adapter plug into a standard power outlet.

RS-232: The scanner can communicate with a standard or Wincor-Nixdorf (W-N) RS-232 host.

RS-232 OPOS: This interface is used for OPOS/UPOS/JavaPOS systems.

Keyboard Wedge Connection

The Keyboard Wedge cable has a 'Y' connection from the scanner. Connect the female to the male end from the keyboard and the remaining end at the keyboard port at the terminal/PC.

Keyboard Wedge (KBW) : When connected using this interface, the host interprets scanned data as keystrokes and supports several international keyboards (for the Windows® environment). See "[Country Mode](#)" on page 36 for a full listing.

USB Connection

Connect the scanner to a USB port on the terminal/PC using the correct USB cable for the interface type you ordered.

USB : Select to communicate either by USB OEM, USB COM STD, or USB Keyboard interface types by scanning the appropriate interface type bar codes available in this manual. The default interface is USB-KBD, or RS-232-STD.

Figure 3. Connection to the Host

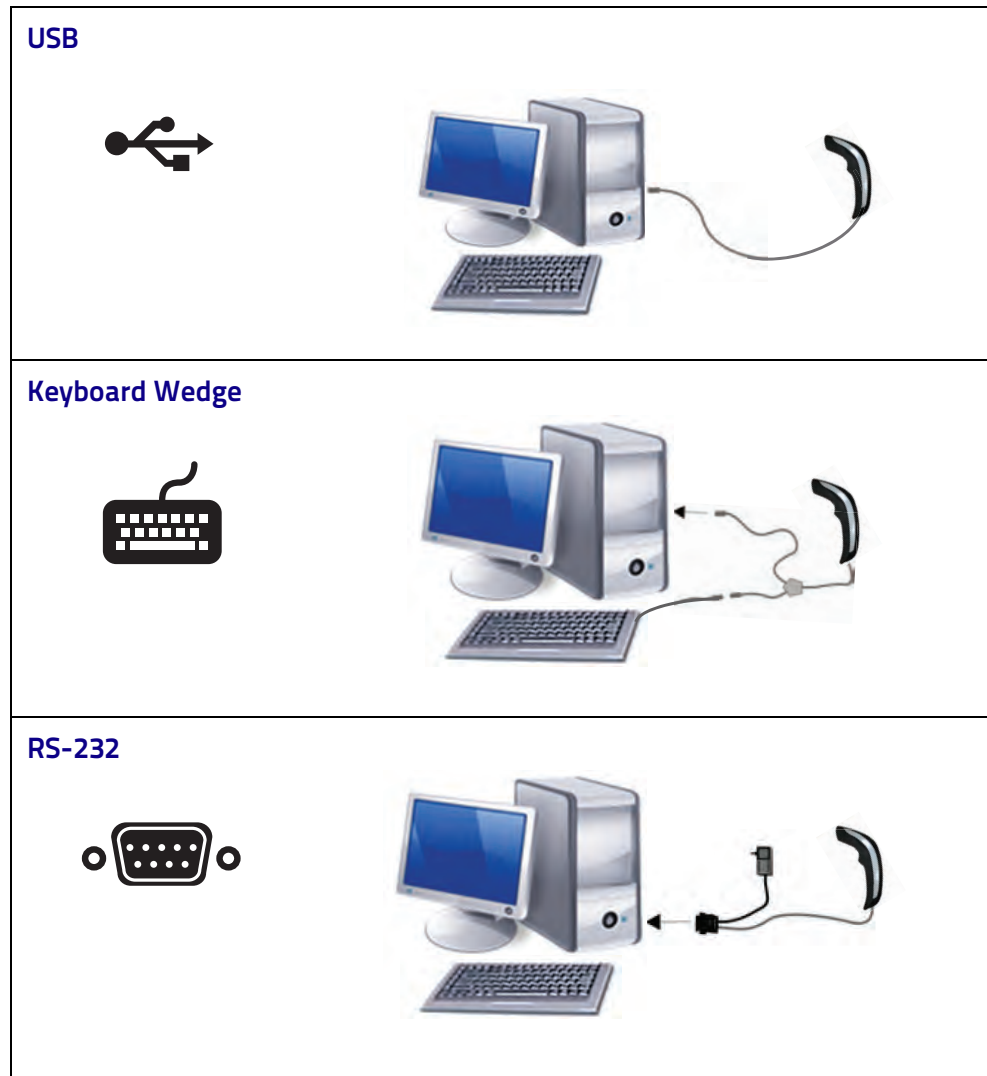
**NOTE**

Specific cables are required for connection to different hosts. The connections illustrated in Figure 3 are examples only. Actual connectors may vary from those illustrated, but the steps to connect the scanner remain the same.

Stand Installation

The stand can be affixed to a flat surface such as a desk or countertop. If needed, it can also be easily removed.

To install the stand:

1. Remove the protective film from the rubber feet and adhere them to the corresponding recessed areas on the bottom surface of the stand.
2. Turn to "Stand Base Plate Template" on page 256. Place the mask at the desired position of the stand base on the desk.
3. Use a pen to mark the location of the small holes (shown in red) on the desk surface. Remove the mask before installing the screws.



4. Screw the 2 wood screws into the desk, centering in the marked holes. Leave about 4–5 mm of the screw protruding from the upper surface of the desk.



NOTE

It is recommended to use two n.2 wood screws ISO 7050, diameter. 3.5 mm, length 16 mm or equivalent. On hard surfaces, an electric screwdriver can be used for easier installation of the screws.

5. Set the stand in place on the screws by aligning the large holes (circled in blue) with the screw heads.

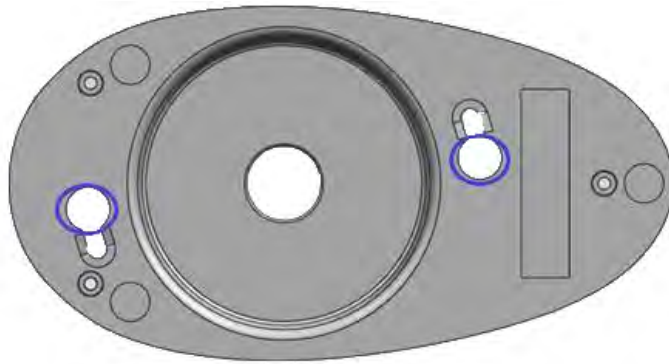

6. Rotate the stand counterclockwise until you feel it lock into place.
7. If the rotation is obstructed, or if the stand does not lock into place, remove the stand and adjust the height of the screws. Retry.
8. To remove the stand, rotate clockwise and lift to detach.

Insertion Into Stand

Place the reader into the stand, taking care to insert the handle into the stand clip as shown.



Correct insertion will be signaled by a beep; then, the reader will be ready to read bar codes.

Using as a Hands-Free Stand

The Heron HD3130 Stand can be used as a hands-free stand.

Once the reader is correctly inserted into the stand, it is immediately ready to automatically read any code present in its reading area without pressing the trigger. A green aiming light is continuously emitted to facilitate the positioning of the bar code to be read. Adjust the stand position as needed, as shown in the following section.

Adjusting the Stand Position

The stand can easily be adjusted to change the inclination of the reader while in the stand.

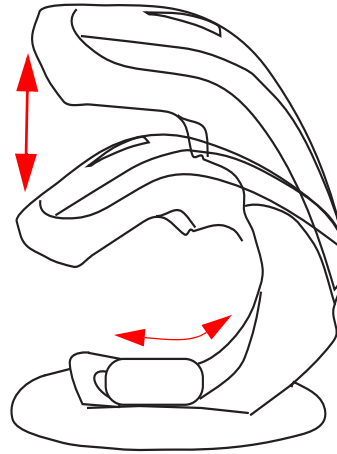

To adjust the stand:

1. With fingers, loosen the screw on the bottom of the stand by turning it counterclockwise.



2. Set the stand upright and slide to adjust to the desired position.



3. Re-tighten the screw to secure the stand.

Interface Selection

Upon completing the physical connection between the scanner and its host, proceed directly to "Configuring the Interface" on page 11 for information and programming for the interface type the scanner is connected to (for example: RS-232, Keyboard Wedge, USB, etc.) and scan the appropriate bar code in that section to select your system's correct interface type.

The scanner, depending upon the model, will support one of the following sets of host interfaces:

USB Models (2.0 full speed)

- USB-KBD
- USB-COM STD
- USB-OEM
- USB-KBD-ALT

RS-232 / Keyboard Wedge Models

- RS-232 (Standard, Wincor-Nixdorf, OPOS)
- Keyboard Wedge

Configuring the Interface

Scan the programming bar code from the following section which selects the appropriate interface type to match the system the scanner will be connected to. Next, proceed to the corresponding chapter in this manual (also listed in the table) to configure any desired settings and features associated with that interface.



NOTE



Unlike some other programming features and options, interface selections require that you scan only one programming bar code label. **DO NOT** scan an ENTER/EXIT bar code prior to scanning an interface selection bar code.

Some interfaces require the scanner to start in the disabled state when powered up. If additional scanner configuration is desired while in this state, pull the trigger and hold it for five seconds. The scanner will change to a state that allows programming with bar codes.

Table 1. Available Interfaces

RS-232		FEATURES
RS-232 standard interface	 Select RS232-STD	Set RS-232 Interface Features starting on page 21
 Select RS232-WN	RS-232 Wincor-Nixdorf	
RS-232 for use with OPOS/UPOS/JavaPOS	 Select RS-232 OPOS	
 Select USB-COM-STD ^a	USB Com to simulate RS-232 standard interface	
USB-OEM		FEATURES
USB-OEM (can be used for OPOS/UPOS/JavaPOS)	 Select USB-OEM	Set USB-OEM Interface Features starting on page 47

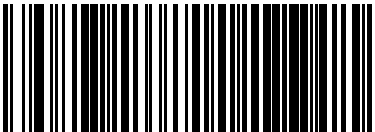
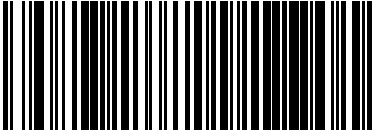
a. Download the correct USB Com driver from www.datalogic.com

KEYBOARD	FEATURES
<p>AT, PS/2 25-286, 30-286, 50, 50Z, 60, 70, 80, 90 & 95 w/Standard Key Encoding</p>  <p>Select KBD-AT</p>	<p>Set KEYBOARD WEDGE Interface Features starting on page 35</p>
 <p>Select KBD-AT-NK</p> <p>Keyboard Wedge for IBM AT PS2 with standard key encoding but without external keyboard</p>	
<p>AT, PS/2 25-286, 30-286, 50, 50Z, 60, 70, 80, 90 & 95 w/Alternate Key</p>  <p>Select KBD-AT-ALT</p>	
 <p>Select KBD-AT-ALT-NK</p> <p>Keyboard Wedge for IBM AT PS2 with alternate key encoding but without external keyboard</p>	
<p>USB Keyboard with standard key encoding</p>  <p>Select USB Keyboard</p>	
 <p>Select USB Alternate Keyboard</p> <p>USB Keyboard with alternate key encoding</p>	

Customizing Configuration Settings

Using the Programming Bar Codes

This manual contains feature descriptions and bar codes which allow you to reconfigure your scanner. Some programming bar code labels, like "Resetting the Product Configuration to Defaults" on page 16, require only the scan of that single label to enact the change. Most of the programming labels in this manual, however, require the scanner to be placed in Programming Mode prior to scanning them. Scan an ENTER/EXIT bar code once to enter Programming Mode. Once the scanner is in Programming Mode, you can scan a number of parameter settings before scanning the ENTER/EXIT bar code a second time, which will then accept your changes, exit Programming Mode and return the scanner to normal operation.



NOTE

There are some exceptions to the typical programming sequence described above. Please read the description and setting instructions carefully when configuring each given programmable feature.

Datalogic Aladdin™ Utility

Programming can alternatively be performed using the Datalogic Aladdin™ Configuration application which is available for free download from the Datalogic website listed on the back cover of this manual. This multi-platform utility program allows device configuration using a PC. It communicates to the device using a serial or USB cable and can also create configuration bar codes to print.

Datalogic Aladdin™ is a multi-platform utility program providing a quick and user-friendly configuration method via the RS-232/USB-COM interface. The Aladdin utility is available on the Datalogic website. Aladdin allows you to program the scanner by selecting configuration commands through a user-friendly graphical interface running on a PC. These commands are sent to the scanner over the selected communication interface, or they can be printed as bar codes to be scanned.

Aladdin also provides the ability to perform a software upgrade for the connected device (see the Datalogic Aladdin™ Help On-Line for more details).

Interface Settings

The scanner is typically factory-configured with a set of default features standard to the interface type you ordered. See "Interface Selection" on page 11.

[Global Interface Features, starting on page 19](#) provides settings configurable by all interface types. If your installation requires you to further customize your scanner, you can select other options through use of the instructions and programming bar codes available in the appropriate section for your interface.

- [RS-232 ONLY Interface, starting on page 21](#)
- [RS-232/USB-COM Interfaces, starting on page 25](#)
- [Keyboard Interface, starting on page 35](#)
- [USB-OEM Interface, starting on page 47](#)

Configuring Other Features

If your installation requires different programming than the standard factory default settings, the following sections of this manual allow configuration of non-interface-specific settings you might require:

Configuration Using Bar Codes: General Features includes programming for scanning, speaker and LED indicators and other such universal settings.

Reading Parameters: Reading Parameters include programming for scanning, speaker and LED indicators and other universal settings.

Symbologies: Includes options concerning the bar code label types (symbologies). These settings allow you to enable/disable symbologies, set label lengths, require check digit, etc.

Software Version Transmission

The software version of the device can be transmitted over the RS-232, Keyboard and USB interfaces by scanning the following label.



Transmit Software Version

Resetting the Product Configuration to Defaults

If you aren't sure what programming options are in your scanner, or you've changed some options and want to restore the Custom Default Configuration that may have been saved in the scanner, scan the [Restore Custom Default Configuration](#) bar code below. This will restore the custom configuration for the currently active interface.



NOTE

Custom defaults are based on the interface type. Configure the scanner for the correct interface before scanning this label.

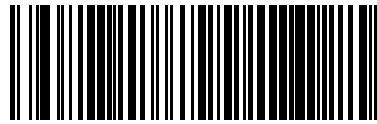

Restore Custom Default Configuration

If you aren't sure what programming options are in your scanner, or you've changed some options and want to restore the Factory Configuration, you have two options. You can scan the [Restore USA Factory Configuration](#) bar code or the [Restore EU Factory Configuration](#) bar code below. Both labels restore the scanner configuration to the factory settings including the interface type. The USA label restores Label IDs to those historically used in the USA. The EU label restores Label IDs to those historically used in Europe. The Label ID sets for USA and EU are shown in the Label ID section of this manual.



CAUTION

Scanning either of the "Restore Factory Configuration" commands below will result in the loss of any custom configuration settings for your device.

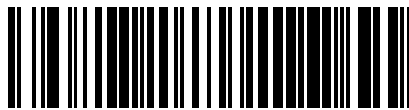

Restore USA Factory Configuration

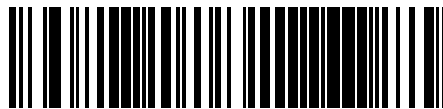

Restore EU Factory Configuration

The programming section on the following pages lists the factory default settings for each of the menu commands (indicated by shaded blocks and bold text).



Chapter 3

Configuration Using Bar Codes

This and following sections provide programming bar codes to configure your scanner by changing the default settings. For details about additional methods of programming, see "Customizing Configuration Settings" on page 14.



NOTE

You must first enable your scanner to read bar codes in order to use this section. If you have not done this, go to Setup, starting on page 5 and complete the appropriate procedure.

Configuration Parameters

Once the scanner is set up, you can change the default parameters to meet your application needs. Refer to "Resetting the Product Configuration to Defaults" on page 16 for initial configuration in order to set the default values and select the interface for your application.

The following configuration parameters are divided into logical groups, making it easy to find the desired function based on its reference group.

Interface Configuration:

- "RS-232 ONLY Interface" on page 21
- "RS-232/USB-COM Interfaces" on page 25
- "Keyboard Interface" on page 35
- "USB-OEM Interface" on page 47

Parameters common to all interface applications:

- "Global Prefix/Suffix" on page 50
- "Data Format" on page 49 offers advanced configuration options for customization of scanned data output.
- "Reading Parameters" on page 61 control various operating modes and indicators status functioning.

Symbology-specific parameters:

"Symbologies" on page 85 defines options for all symbologies and provides the programming bar codes necessary for configuring these features.



NOTE

You must first enable your scanner to read bar codes in order to use this section. If you have not done this, go to Setup, starting on page 5 and complete the appropriate procedure.



To program features:

1. Scan the ENTER/EXIT PROGRAMMING bar code, available at the top of each programming page, when applicable.
2. Scan the bar code to set the desired programming feature. You may need to cover unused bar codes on the page, and possibly the facing page, to ensure that the scanner reads only the bar code you intend to scan.
3. If additional input parameters are needed, go to [Appendix D, Keypad](#), and scan the appropriate characters from the keypad.



NOTE

Additional information about many features can be found in the "References" chapter.

If you make a mistake before the last character, scan the CANCEL bar code to abort and not save the entry string. You can then start again at the beginning.

4. Complete the programming sequence by scanning the ENTER/EXIT PROGRAMMING bar code to exit Programming Mode.

For more detailed descriptions, programming information and examples for setting selected configuration items, see [References, starting on page 217](#).

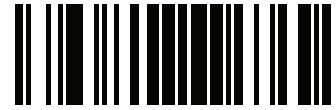

Global Interface Features

The following interface features are configurable by all interface types. To set features specific to your interface, turn to that section of this manual.

HOST COMMANDS — OBEY/IGNORE on page 19
USB SUSPEND MODE on page 20

Host Commands — Obey/Ignore

This option specifies whether the scanner will obey or ignore host commands. When set to ignore, the scanner will ignore all host commands except for those necessary for:

- service mode
- flash programming mode
- keeping the interface active
- transmission of labels.

	 Host Commands = Obey
 Host Commands = Ignore	



Enter/Exit Programming Mode

USB Suspend Mode

This setting enables/disables the ability of the USB interface to enter suspend mode.

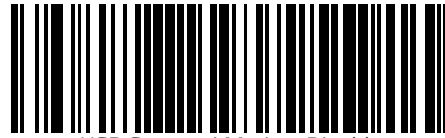
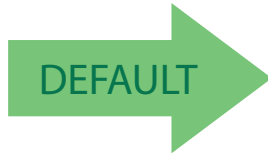

USB Suspend Mode = Disable

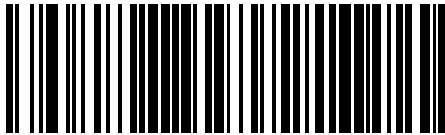

USB Suspend Mode = Enable

RS-232 ONLY Interface

Use the programming bar codes in this chapter if modifications to the standard RS-232 interface settings are necessary to meet your system’s requirements. Additional settings which apply to both the RS-232 and USB interfaces are available in [Chapter 5, RS-232/USB-COM Interfaces](#).

BAUD RATE on page 21	PARITY on page 23
STOP BITS on page 22	HANDSHAKING CONTROL on page 24

RS-232 Standard Factory Settings

Reference [Appendix B, Standard Defaults](#) for a listing of standard factory settings.

Baud Rate

Baud rate is the number of bits of data transmitted per second. Set the scanner's baud rate to match the baud rate setting of the host device. With an improper baud rate setting, data may not reach the host correctly.

	 <p>Baud Rate = 1200</p>
 <p>Baud Rate = 2400</p>	
	 <p>Baud Rate = 4800</p>
 <p>Baud Rate = 9600</p>	



Baud Rate (continued)

	 Baud Rate = 19,200
 Baud Rate = 38,400	
	 Baud Rate = 57,600
 Baud Rate = 115,200	

Stop Bits

The stop bit(s) at the end of each transmitted character marks the end of transmission of one character and prepares the receiving device for the next character in the serial data stream. The number of stop bits selected (one or two) depends on the number the receiving terminal is programmed to accommodate. Set the number of stop bits to match host device requirements.

	 1 Stop Bit
 2 Stop Bits	

Parity

This feature specifies parity required for sending and receiving data. A parity check bit is the most significant bit of each ASCII coded character. Select the parity type according to host device requirements.

- Select None when no parity bit is required.
- Select Odd parity and the parity bit value is set to 0 or 1, based on data, to ensure that an odd number of 1 bits are contained in the coded character.
- Select Even parity and the parity bit value is set to 0 or 1, based on data, to ensure that an even number of 1 bits are contained in the coded character.



	 <p>Parity = None</p>
 <p>Parity = Even</p>	
	 <p>Parity = Odd</p>



Handshaking Control

The data interface consists of an RS-232 port designed to operate either with or without the hardware handshaking lines, Request to Send (RTS), and Clear to Send (CTS). Handshaking Control includes the following options:

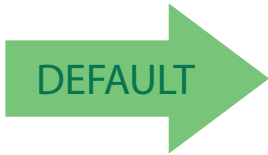
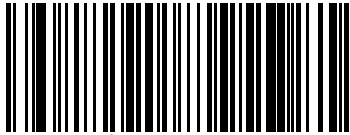
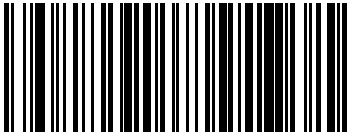
- RTS — RTS is asserted during transmissions. CTS is ignored.
- RTS/CTS — RTS is asserted during transmissions. CTS gates transmissions.
- RTS/XON/XOFF — RTS is asserted during transmissions. CTS is ignored. XON and XOFF gate transmissions.
- RTS On/CTS — RTS is always asserted. CTS gates transmissions.
- RTS/CTS Scan Control — RTS is asserted during transmissions. CTS gates transmissions and controls enable and disable state of scanner.

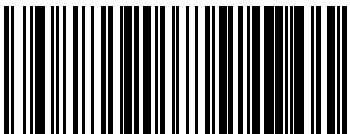
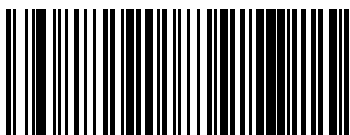
	 <p>Handshaking Control = RTS</p>
 <p>Handshaking Control = RTS/CTS</p>	
	 <p>Handshaking Control = RTS/XON/XOFF</p>
 <p>Handshaking Control = RTS On/CTS</p>	
	 <p>Handshaking Control = RTS/CTS Scan Control</p>

RS-232/USB-COM Interfaces

The programming bar codes in this chapter allow modifications to the standard RS-232 and USB-Com interfaces.

INTERCHARACTER DELAY on page 26
BEEP ON ASCII BEL on page 27
BEEP ON NOT ON FILE on page 27
ACK NAK OPTIONS on page 28
ACK CHARACTER on page 29
NAK CHARACTER on page 29
ACK NAK TIMEOUT VALUE on page 30
ACK NAK RETRY COUNT on page 31
ACK NAK ERROR HANDLING on page 32
INDICATE TRANSMISSION FAILURE on page 33
DISABLE CHARACTER on page 33
ENABLE CHARACTER on page 34

Standard Factory Settings

Reference [Appendix B, Standard Defaults](#) for a listing of standard factory settings.



Intercharacter Delay

This parameter specifies the intercharacter delay between the end of one character and the beginning of the next. The delay can be set within a range of zero (0) to 990 milliseconds in 10ms increments. A setting of zero specifies no delay. See "Label ID: Pre-loaded Sets" on page 232 for more detailed programming instructions.

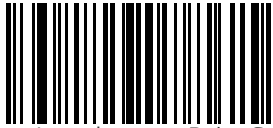
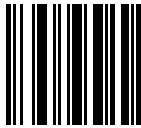
	 <p>Intercharacter Delay = No Delay</p>
 <p>Select Intercharacter Delay Setting</p>	<p>To configure this feature, scan the ENTER/EXIT bar code above, then the bar code at left followed by digits from the Alphanumeric characters in Appendix D, Keypad representing your desired character(s). End by scanning the ENTER/EXIT bar code again.</p>
<p>Make a mistake? Scan the CANCEL bar code to abort and not save the entry string. You can then start again at the beginning.</p>	 <p>CANCEL</p>

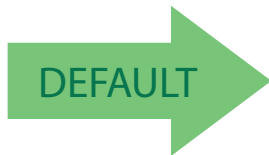

00 = No Intercharacter Delay

Beep On ASCII BEL

When this parameter is enabled, the scanner issues a beep when a <BEL> character is detected on the RS-232 serial line. <BEL> is issued to gain a user's attention to an illegal entry or other important event.

 Beep On ASCII BEL = Disable	
	 Beep On ASCII BEL = Enable

Beep On Not on File

This option enables/disables the action of the scanner to sound a three beep sequence upon receiving a Not-On-File (NOF) host command.

 Beep On Not On File = Disable	
	 Beep On Not On File = Enable



ACK NAK Options

This enables/disables the ability of the scanner to support the RS-232 ACK/NAK protocol. When configured, the scanner and/or host sends an “ACK” when it receives data properly, and sends “NAK” when the data is in error.

Options are:

- Disable
- Enable for label transmission — The scanner expects an ACK/NAK response from the host when a label is sent.
- Enable for host-command acknowledge — The scanner will respond with ACK/NAK when the host sends a command.
- Enable for label transmission and host-command acknowledge

	 <p>ACK/NAK Protocol = Disable ACK/NAK</p>
 <p>ACK/NAK Protocol = Enable for label transmission</p>	
	 <p>ACK/NAK Protocol = Enable for host-command acknowledge</p>
 <p>ACK/NAK Protocol = Enable for label transmission and host-command acknowledge</p>	

ACK Character

This setting specifies an ASCII character or hex value to be used as the ACK character. ASCII characters or any hex value from 0 to 0xFF can be selected. See "ACK Character" on page 220 for more detailed programming instructions.



NOTE

Setting to previously defined characters such as XON, XOFF, or host commands conflicts with normal operation of these characters. 8-bit data is not recognized when the option Stop Bits on page 22 has been set as 7 Data Bits.

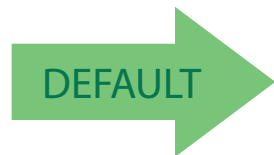

0x06 'ACK' Character

NAK Character

This setting specifies an ASCII character or hex value to be used as the NAK character. ASCII characters or any hex value from 0 to 0xFF can be selected. See "NAK Character" on page 221 for more detailed programming instructions.



NOTE

Setting to previously defined characters such as XON, XOFF, or host commands conflicts with normal operation of these characters. 8-bit data is not recognized when the option Stop Bits on page 22 has been set as 7 Data Bits.

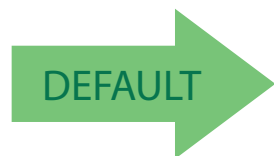

0x15 'NAK' Character



ACK NAK Timeout Value

This option specifies the amount of time the scanner waits for an ACK character from the host following label transmission. The selectable timeout range is 200 milliseconds to 15,000ms (15 seconds) in 200ms increments. A selection of 0 disables the timeout. See "ACK NAK Timeout Value" on page 222 for more detailed programming instructions.

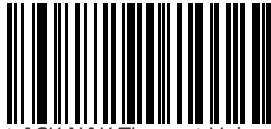

Select ACK NAK Timeout Value Setting

To configure this feature, scan the ENTER/EXIT bar code above, then the bar code at left followed by digits from the Alphanumeric characters in **Appendix D, Keypad** representing your desired character(s). End by scanning the ENTER/EXIT bar code again.

Make a mistake? Scan the CANCEL bar code to abort and not save the entry string. You can then start again at the beginning.



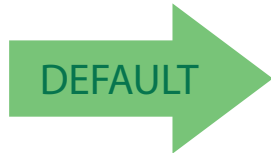

CANCEL



01 ACK NAK Timeout value is 200ms

ACK NAK Retry Count

This feature specifies the number of times the scanner retries a label transmission due to a retry condition. The selectable range is from 1 to 254 retries. A selection of 0 disables the count, and a selection of 255 specifies unlimited retries. See "ACK NAK Retry Count" on page 223 for more detailed programming instructions.

 Select ACK NAK Retry Count Setting	To configure this feature, scan the ENTER/EXIT bar code above, then the bar code at left followed by digits from the Alphanumeric characters in Appendix D, Keypad representing your desired character(s). End by scanning the ENTER/EXIT bar code again.
Make a mistake? Scan the CANCEL bar code to abort and not save the entry string. You can then start again at the beginning.	 CANCEL

003 = 3 Retries





ACK NAK Error Handling

This feature specifies the method the scanner uses to handle receive errors detected while waiting for an ACK character from the host.

Options are:

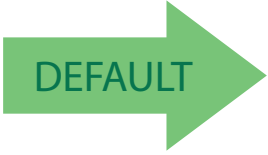
- Ignore errors detected
- Process error as valid ACK character
- Process error as valid NAK character

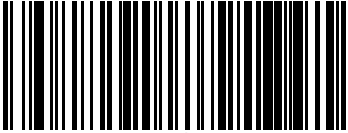
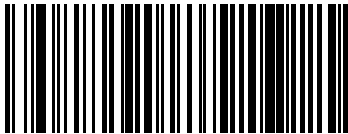
	 ACK NAK Error Handling = Ignore Errors Detected
 ACK NAK Error Handling = Process Error as Valid ACK Character	
	 ACK NAK Error Handling = Process Error as Valid NAK Character

Indicate Transmission Failure

This option enables/disables the scanner's ability to sound an error beep to indicate a transmission failure while in ACK/NAK mode.

	 Indicate Transmission Failure = Disable Indication
 Indicate Transmission Failure = Enable Indication	

Disable Character

Specifies the value of the RS-232 host command used to disable the scanner. ASCII characters or any hex value from 0 to 0xFF can be selected. See "Disable Character" on page 224 for more detailed programming instructions.

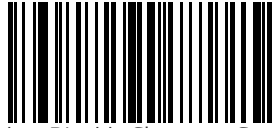

Setting to previously defined characters such as XON, XOFF, or host commands conflicts with normal operation of these characters.

 Select Disable Character Setting	
---	--

0x44 = Disable Character is 'D'



Enable Character

Specifies the value of the RS-232 host command used to enable the scanner. ASCII characters or any hex value from 0 to 0xFF can be selected. See "Enable Character" on page 225 for more detailed programming instructions.



NOTE

Setting to previously defined characters such as XON, XOFF, or host commands conflicts with normal operation of these characters.

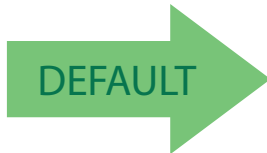

0x45 = Enable Character is 'E'

Keyboard Interface

Use the programming bar codes in this chapter to select options for USB Keyboard and Wedge Interfaces. Reference [Appendix B, Standard Defaults](#) for a listing of standard factory settings. Information about control character emulation which applies to keyboard interfaces is listed in [Appendix E, Scancode Tables](#).

COUNTRY MODE on page 36
CAPS LOCK STATE on page 39
NUMLOCK on page 39
KEYBOARD NUMERIC KEYPAD on page 40
KEYBOARD SEND CONTROL CHARACTERS on page 41
WEDGE QUIET INTERVAL on page 42
INTERCODE DELAY on page 44
USB KEYBOARD SPEED on page 45



Country Mode

This feature specifies the country/language supported by the keyboard. The Country Mode setting is ignored if the interface uses alternate key encoding.

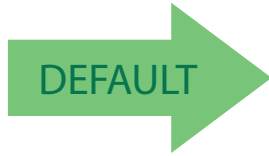

Country Mode = U.S.

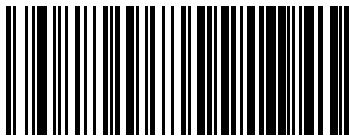

Country Mode = Belgium

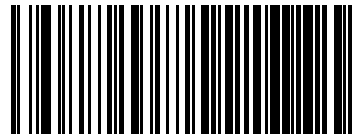

Country Mode = Britain

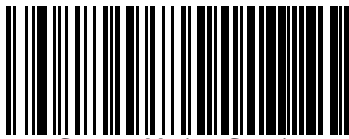

Country Mode = Croatia

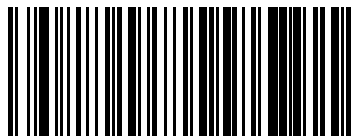

Country Mode = Czech Republic

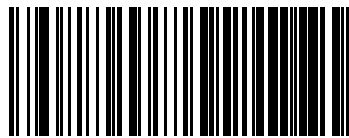

Country Mode = Denmark

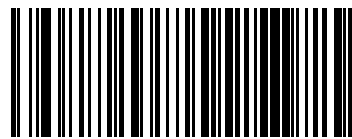

Country Mode = France

Country Mode (continued)



Country Mode = Germany

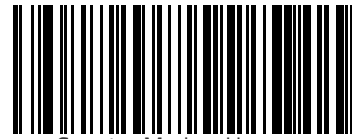

Country Mode = Hungary

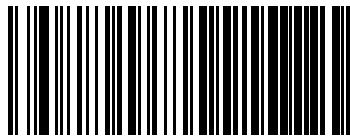

Country Mode = Italy

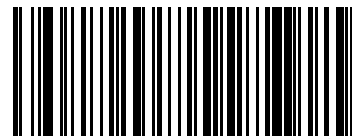

Country Mode = Japanese 106-key

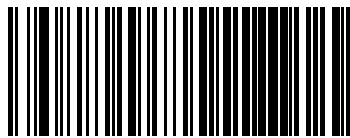

Country Mode = Norway

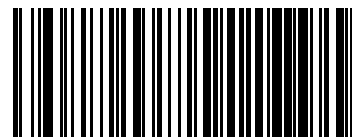

Country Mode = Poland

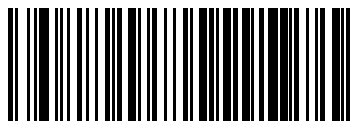

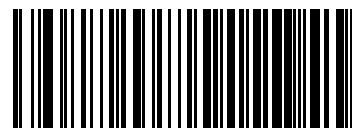

Country Mode = Portugal



Country Mode = Romania

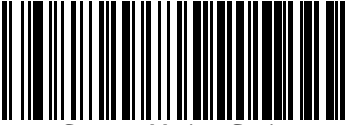
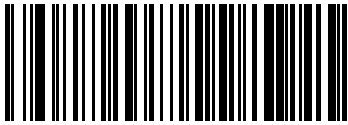
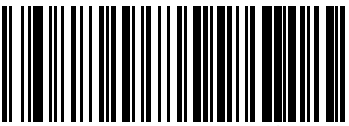
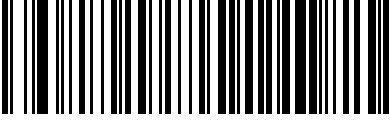

Country Mode (continued)

	 Country Mode = Slovakia
 Country Mode = Spain	
	 Country Mode = Sweden
 Country Mode = Switzerland	
	 Country Mode = French Canadian
 Country Mode = Lithuania	

Caps Lock State

This option specifies the format in which the scanner sends character data. This applies to Keyboard Wedge interfaces. This does not apply when an alternate key encoding keyboard is selected. This does not apply to USB Keyboard.

	 Caps Lock State = Caps Lock OFF
 Caps Lock State = Caps Lock ON	
	 Caps Lock State = AUTO Caps Lock Enable

Numlock

This option specifies the setting of the Numbers Lock (Numlock) key while in Keyboard Wedge interface. This only applies to alternate key encoding interfaces. It does not apply to USB Keyboard.

	 Numlock = Numlock key unchanged
 Numlock = Numlock key toggled	



Keyboard Numeric Keypad

This feature specifies if numeric characters will be sent using the standard keys or the numeric keypad.

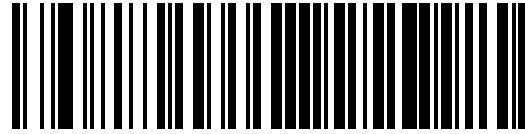
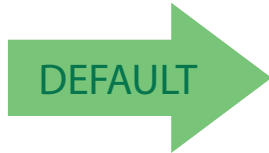

Keyboard Numeric Keypad = Standard Keys

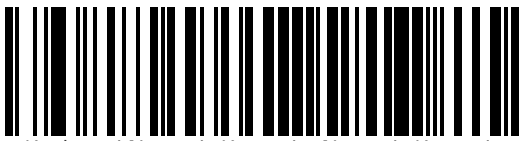

Keyboard Numeric Keypad = Numeric Keypad

Keyboard Send Control Characters

This feature is used by the Keyboard Wedge and USB Keyboard interfaces. It specifies how the scanner transmits ASCII control characters to the host. Reference [Appendix E, Scancode Tables](#) for more information about control characters.

Options are as follows:

Send Ctrl+Key : ASCII characters from 00H to 0x1FH inclusive are transmitted in the format Ctrl+Key. Special keys are available in the range from 81H to A1.

Send Ctrl+Shift+Key : The behavior is the same as above, but control keys are sent in the format Ctrl+Shift+Keys.

Send Special Function Key : Send characters between 00H and 1FH according to the special function key mapping table (see "[Interface Type PC AT PS/2 Alt Mode or USB-Keyboard Alt Mode](#)" on page 282). This is used to send keys that are not in the normal ASCII set. A unique set is provided for each available scancode set.

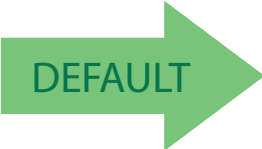
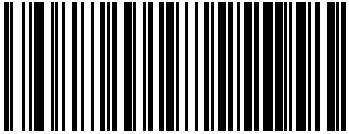
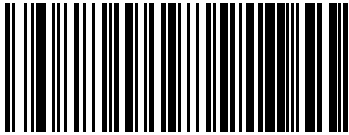
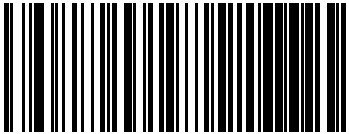
	 <p>Keyboard Send Control Characters = Send Ctrl+Key</p>
 <p>Keyboard Send Control Characters = Send Ctrl+Shift+Key</p>	
	 <p>Keyboard Send Control Characters = Send Special Function Key :</p>



Wedge Quiet Interval

This option specifies the amount of time to look for keyboard activity before the scanner breaks the keyboard connection in order to transmit data to host. The selectable range for this feature is from 0 to 990ms in 10ms increments. See "Wedge Quiet Interval" on page 226 for more detailed programming instructions.



NOTE

This feature applies **ONLY** to the Keyboard Wedge interface.

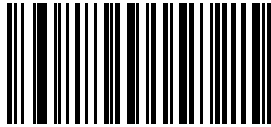

Select Wedge Quiet Interval Setting

To configure this feature, scan the ENTER/EXIT bar code above, then the bar code at left followed by digits from the Alphanumeric characters in [Appendix D, Keypad](#) representing your desired character(s). End by scanning the ENTER/EXIT bar code again.

Make a mistake? Scan the CANCEL bar code to abort and not save the entry string. You can then start again at the beginning.

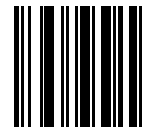

CANCEL

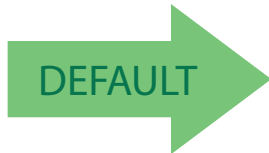

10 = Quiet Interval of 100 ms

Intercharacter Delay

This parameter specifies the intercharacter delay between the end of one character and the beginning of the next. The delay can be set within a range of zero (0) to 990 milliseconds in 10ms increments. A setting of zero specifies no delay. See "Intercharacter Delay" on page 227 for more detailed programming instructions.

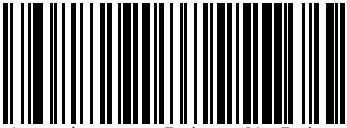
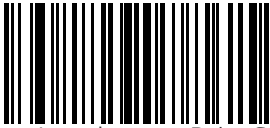
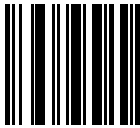
	 Intercharacter Delay = No Delay
 Select Intercharacter Delay Setting	To configure this feature, scan the ENTER/EXIT bar code above, then the bar code at left followed by digits from the Alphanumeric characters in Appendix D, Keypad representing your desired character(s). End by scanning the ENTER/EXIT bar code again.
Make a mistake? Scan the CANCEL bar code to abort and not save the entry string. You can then start again at the beginning.	 CANCEL

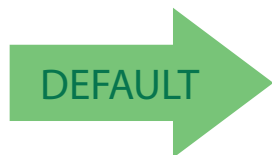
00 = No Intercharacter Delay



Intercode Delay

Specifies the delay between labels transmitted to the host for this interface. The selectable range for this feature is from 0 to 99 seconds. See "Intercode Delay" on page 228 for more detailed programming instructions.



Set Intercode Delay

To configure this feature, scan the ENTER/EXIT bar code above, then the bar code at left followed by digits from the Alphanumeric characters in [Appendix D, Keypad](#) representing your desired character(s). End by scanning the ENTER/EXIT bar code again.

Make a mistake? Scan the CANCEL bar code to abort and not save the entry string. You can then start again at the beginning.

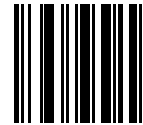

CANCEL

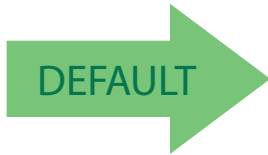

00 = No Wedge Intercode Delay



USB Keyboard Speed

This option specifies the USB poll rate for a USB Keyboard.

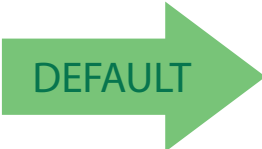
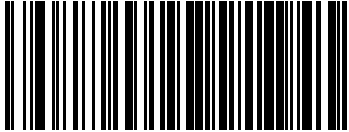
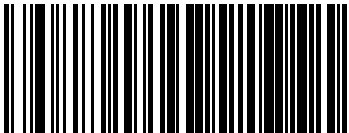
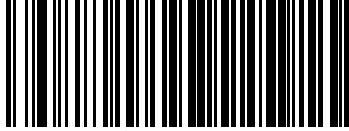

This feature applies **ONLY** to the USB Keyboard interface.

NOTE

	 USB Keyboard Speed = 1ms
 USB Keyboard Speed = 2ms	
	 USB Keyboard Speed = 3ms
 USB Keyboard Speed = 5ms	
	 USB Keyboard Speed = 7ms
 USB Keyboard Speed = 10ms	

NOTES

USB-OEM Interface

USB-OEM DEVICE USAGE on page 48
USB-OEM INTERFACE OPTIONS on page 48

Introduction

Feature settings for USB interfaces differ depending upon which host type the scanner will be connected with. Use the feature settings in this chapter to specifically configure for the USB-OEM interface. Other USB interfaces are included in the appropriate chapter for their host type.

Standard Factory Settings

Reference [Appendix B, Standard Defaults](#) for a listing of standard factory settings.



USB-OEM Device Usage

The USB-OEM protocol allows for the scanner to be identified as one of two different types of bar code scanners. Depending on what other scanners you may already have connected to a USB-OEM POS, you may need to change this setting to enable all devices to communicate.

Options are:

- Tabletop Scanner
- Handheld Scanner



NOTE

It may be necessary to switch device usage when connecting two scanners of the same type to a POS system.

	 USB-OEM Device Usage = Tabletop Scanner
 USB-OEM Device Usage = Handheld Scanner	

USB-OEM Interface Options

This setting provides for an interface specific control mechanism.

Options are:

- Obey — Obey Scanner Configuration Host Commands
- Ignore — Ignore Scanner Configuration Host Commands

	 USB-OEM Interface Options = Obey
 USB-OEM Interface Options = Ignore	

Data Format



GLOBAL PREFIX/SUFFIX on page 50
GLOBAL AIM ID on page 51
LABEL ID starting on page 52 <ul style="list-style-type: none">•Label ID: Pre-loaded Sets on page 52•Label ID: Set Individually Per Symbology on page 53•Label ID Control on page 53•Label ID Symbology Selection on page 54
CASE CONVERSION on page 60
CHARACTER CONVERSION on page 60

The features in this chapter can be used to build specific user-defined data into a message string. See "[References](#)" starting on page 217 for more detailed instructions on setting these features.

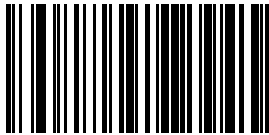
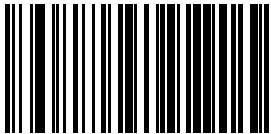

Global Prefix/Suffix

Up to 20 ASCII characters may be added as a prefix (in a position before the bar code data) and/or as a suffix (in a position following the bar code data). See "Global Prefix/Suffix" on page 230 for more detailed programming instructions.

<p>To configure this feature, scan the ENTER/EXIT bar code above, then the bar code at left followed by digits from the Alphanumeric characters in Appendix D, Keypad representing your desired character(s). End by scanning the ENTER/EXIT bar code again.</p>	 <p>Set Global Prefix</p>
 <p>Set Global Suffix</p>	<p>To configure this feature, scan the ENTER/EXIT bar code above, then the bar code at left followed by digits from the Alphanumeric characters in Appendix D, Keypad representing your desired character(s). End by scanning the ENTER/EXIT bar code again.</p>
<p>Make a mistake? Scan the CANCEL bar code to abort and not save the entry string. You can then start again at the beginning.</p>  <p>CANCEL</p>	

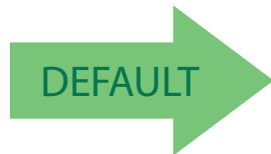

No Global Prefix
Global Suffix = 0x0D(CR)



Global AIM ID



This feature enables/disables addition of AIM IDs for all symbology types.

NOTE

AIM label identifiers (as opposed to custom characters you select yourself as with label identifiers) can be included with scanned bar code data. See "Global AIM ID" on page 231 for more detailed programming instructions.

GS1-128 AIM ID

If Global AIM ID is disabled, the AIM ID for GS1-128 can be enabled/disabled independently. The AIM ID for GS1-128 is a]C1,]C2 or]C3. AIM IDs for other symbologies can be enabled/disabled independently as well. Contact Customer Support for assistance.



Label ID

A Label ID is a customizable code of up to three ASCII characters (each can be one of hex 0x01–0xFF), used to identify a bar code (symbology) type. It can be appended previous to or following the transmitted bar code data depending upon how this option is enabled. This feature provides options for configuring custom Label IDs as a pre-loaded set (see "Label ID: Pre-loaded Sets" on page 52) or individually per symbology (see "Label ID: Set Individually Per Symbology" on page 53). If you wish to program the scanner to always include an industry standard label identifier for ALL symbology types, see the previous feature "Global AIM ID" on page 51.

Label ID: Pre-loaded Sets

The scanner supports two pre-loaded sets of Label IDs, the USA set and the EU set. See "Label ID: Pre-loaded Sets" on page 232 for more information concerning the pre-loaded sets that are provided.



CAUTION

When changing from one Label ID set to another, all other scanner configuration settings, including the host interface type, will be erased and set to the factory defaults. Any custom configuration or custom defaults will be lost.

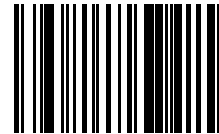
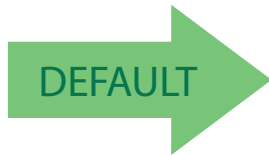

Label ID Pre-loaded Set = USA Set

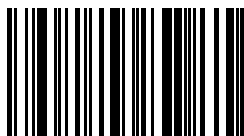

Label ID Pre-loaded Set = EU Set

Label ID: Set Individually Per Symbology

This feature configures a Label ID individually for a single symbology.



NOTE

This setting requires the scanning of bar codes from multiple sections. See "Label ID: Set Individually Per Symbology" on page 234 for more detailed programming instructions.

Label ID Control

This option controls whether a Label ID is disabled, or sent as a prefix or suffix for a given symbology type.

	 <p>Label ID Transmission = Disable</p>
 <p>Label ID Transmission = Enable as Prefix</p>	
	 <p>Label ID Transmission = Enable as Suffix</p>
 <p>CANCEL</p>	<p>Make a mistake? Scan the CANCEL bar code to abort and not save the entry string. You can then start again at the beginning.</p>



Label ID Symbology Selection

This option selects the symbology for which a Label ID is to be configured. See "Label ID: Set Individually Per Symbology" on page 234 for full instructions.

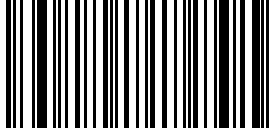
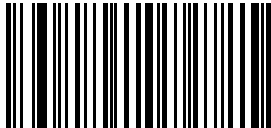
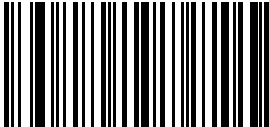
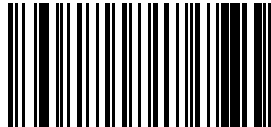
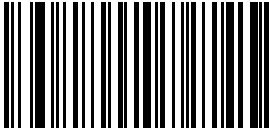
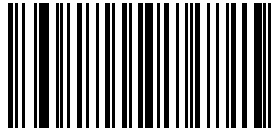
	 <p>Set UPC-A Label ID Character(s)</p>
 <p>Set UPC-A/P2 Label ID Character(s)</p>	
	 <p>Set UPC-A/P5 Label ID Character(s)</p>
 <p>Set UPC-E Label ID Character(s)</p>	
	 <p>Set UPC-E/P2 Label ID Character(s)</p>
 <p>Set UPC-E/P5 Label ID Character(s)</p>	

Label ID Symbology Selection (continued)

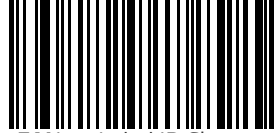
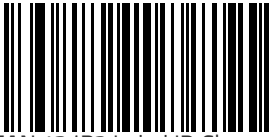
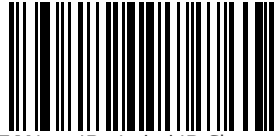
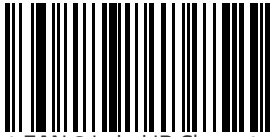
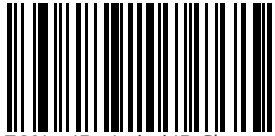
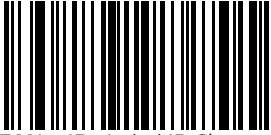
	 <p>Set EAN 13 Label ID Character(s)</p>
 <p>Set EAN 13/P2 Label ID Character(s)</p>	
	 <p>Set EAN 13/P5 Label ID Character(s)</p>
 <p>Set EAN 8 Label ID Character(s)</p>	
	 <p>Set EAN 8/P2 Label ID Character(s)</p>
 <p>Set EAN 8/P5 Label ID Character(s)</p>	



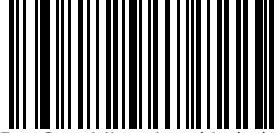
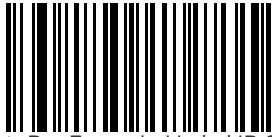
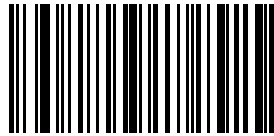
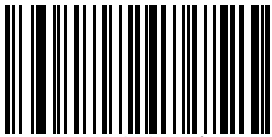
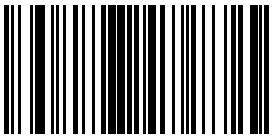
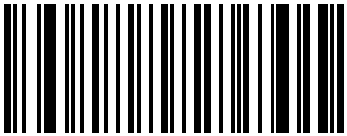

Label ID Symbology Selection (continued)

	 <p>Set GS1 DataBar Omnidirectional Label ID Character(s)</p>
 <p>Set GS1 DataBar Expanded Label ID Character(s)</p>	
	 <p>Set GS1 DataBar Limited Label ID Character(s)</p>
 <p>Set Code 39 Label ID Character(s)</p>	
	 <p>Set Code 32 Label ID Character(s)</p>
 <p>Set Code 39 CIP Label ID Character(s)</p>	

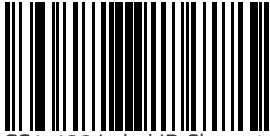

Label ID Symbology Selection (continued)

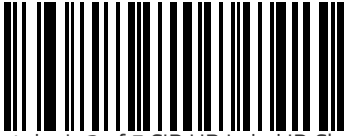
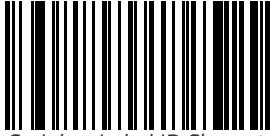
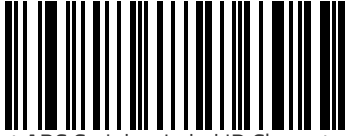
 <p>Set Code 128 Label ID Character(s)</p>	
	 <p>Set GS1-128 Label ID Character(s)</p>
 <p>Set Interleaved 2 of 5 Label ID Character(s)</p>	
	 <p>Set Interleaved 2 of 5 CIP HR Label ID Character(s)</p>
 <p>Set Datalogic 2 of 5 CIP HR Label ID Character(s)</p>	
	 <p>Set Codabar Label ID Character(s)</p>
 <p>Set ABC Codabar Label ID Character(s)</p>	

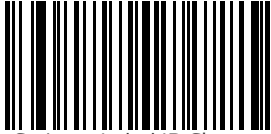
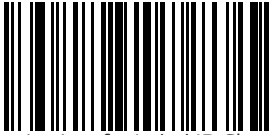
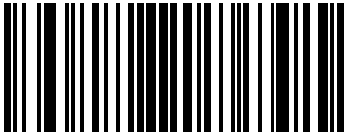
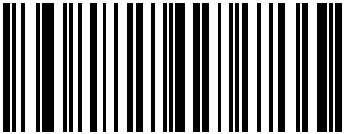
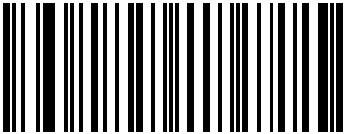
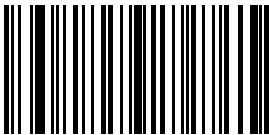
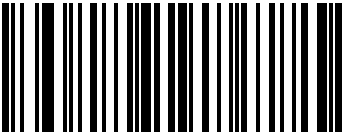
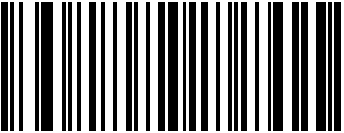

Label ID Symbology Selection (continued)

 <p>Set Code 11 Label ID Character(s)</p>	
	 <p>Set Standard 2 of 5 Label ID Character(s)</p>
 <p>Set Industrial 2 of 5 Label ID Character(s)</p>	
	 <p>Set ISSN Label ID Character(s)</p>
 <p>Set IATA Label ID Character(s)</p>	
	 <p>Set Concatenated ISBT 128 Label ID Character(s)</p>
 <p>Set MSI Label ID Character(s)</p>	
	 <p>Set Code 93 Label ID Character(s)</p>

Label ID Symbology Selection (continued)

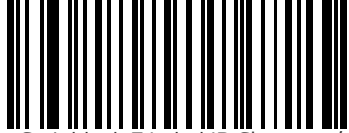
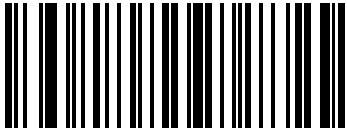
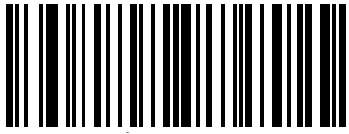
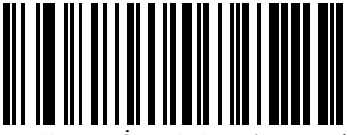
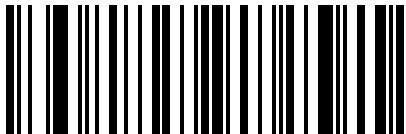
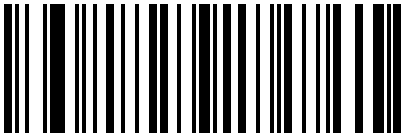
 <p>Set Codablock F Label ID Character(s)</p>	
	 <p>Set Code 4 Label ID Character(s)</p>
 <p>Set Code 5 Label ID Character(s)</p>	
	 <p>Set Follett 2 of 5 Label ID Character(s)</p>
 <p>Set ISBN Label ID Character(s)</p>	
	 <p>Set Concatenated ISBT Label ID Character(s)</p>



Case Conversion

This feature allows conversion of the case of all alphabetic characters to upper or lower case.



NOTE

Case conversion affects **ONLY** scanned bar code data, and does not affect Label ID, Prefix, Suffix, or other appended data.

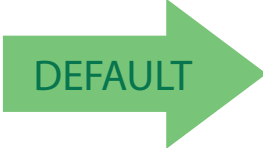
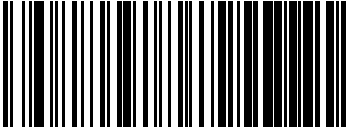
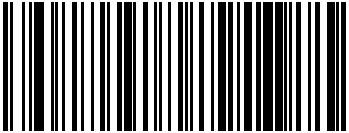
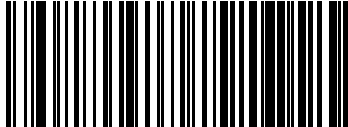
	 Case Conversion = Disable (no case conversion)
 Case Conversion = Convert to upper case	
	 Case Conversion = Convert to lower case

Character Conversion

Character conversion is an eight byte configuration item. The eight bytes are 4 character pairs represented in hexadecimal ASCII values. The first character in the pair is the character that will be converted. The second character in the pair is the character to convert to. If the character to convert in a pair is FF, then no conversion is done. See "[Character Conversion](#)" on page 236 for more detailed programming instructions.

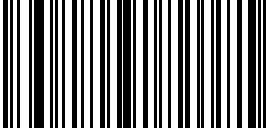
	 Configure Character Conversion
--	--

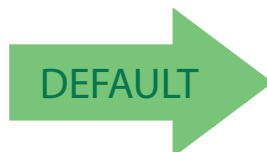

OxFFFFFFFFFFFFFFFF
(No character conversion)

Reading Parameters

DOUBLE READ TIMEOUT on page 62	ENABLE/DISABLE RGB LED on page 76
LABEL GONE TIMEOUT on page 64	GOOD READ LED COLOR on page 77
LED AND SPEAKER INDICATORS on page 65	RGB GOOD READ RAISING TIME on page 77
POWER ON ALERT on page 65	RGB GOOD READ FALLING TIME on page 78
AUDIO JINGLE ENABLE on page 66	RGB GOOD READ HOLDING TIME on page 78
SELECT AUDIO JINGLE FOR POWER-UP EVENT on page 67	RGB AUTO DELAY on page 79
SELECT AUDIO JINGLE FOR GOOD READ EVENT on page 68	SCAN MODE on page 80
GOOD READ: WHEN TO INDICATE on page 72	STAND MODE TRIGGERED TIMEOUT on page 81
GOOD READ BEEP TYPE on page 73	SCANNING ACTIVE TIME on page 82
GOOD READ BEEP FREQUENCY on page 73	STAND MODE FLASH on page 83
GOOD READ SPEAKER VOLUME on page 74	FLASH ON TIME on page 83
GOOD READ BEEP LENGTH on page 75	FLASH OFF TIME on page 84
	STAND MODE SENSITIVITY on page 84







Double Read Timeout

To prevent a double read of the same label, the Double Read Timeout sets the minimum time allowed between reads of labels of the same symbology and data. If the unit reads a label and sees the same label again within the Double Read Timeout, the second read of the label will be ignored. Double Read Timeout does not apply to scan modes that require a trigger pull for each label that is read.

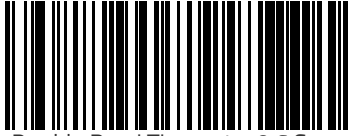
	 Double Read Timeout = 0.1 Second
 Double Read Timeout = 0.2 Second	
	 Double Read Timeout = 0.3 Second
 Double Read Timeout = 0.4 Second	

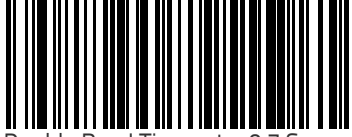
Double Read Timeout (continued)

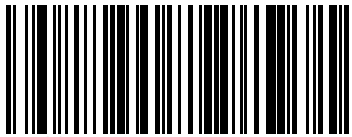
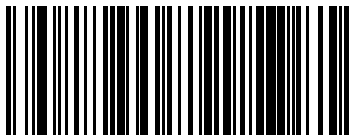
	 <p>Double Read Timeout = 0.5 Second</p>
 <p>Double Read Timeout = 0.6 Second</p>	
	 <p>Double Read Timeout = 0.7 Second</p>
 <p>Double Read Timeout = 0.8 Second</p>	
	 <p>Double Read Timeout = 0.9 Second</p>
 <p>Double Read Timeout = 1 Second</p>	



Label Gone Timeout

This feature sets the time after the last label segment is seen before the scanner prepares for a new label. The timeout can be set within a range of 10 milliseconds to 2,550 milliseconds (2.55 seconds) in 10ms increments. Label Gone Timeout does not apply to scan modes that require a trigger pull for each label that is read. See "Label Gone Timeout" on page 237 for more detailed programming instructions.



To configure this feature, scan the ENTER/EXIT bar code above, then the bar code at left followed by digits from the Alphanumeric characters in [Appendix D, Keypad](#) representing your desired character(s). End by scanning the ENTER/EXIT bar code again.

Make a mistake? Scan the CANCEL bar code to abort and not save the entry string. You can then start again at the beginning.

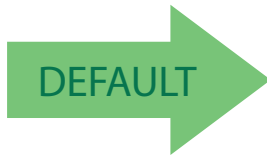

016 = Timeout of 160 ms

LED and Speaker Indicators

Power On Alert

Disables or enables the indication (from the Speaker) that the scanner is receiving power.

	 Power On Alert = Disable (No Audible Indication)
 Power On Alert = Power-up Beep	

Audio Jingles

The scanner can be set up to sound a predefined “jingle” (a short, user-defined tune uploaded via Datalogic Aladdin™ configuration software) or traditional beep sounds to indicate good read and power-up events.

To upload a jingle in Aladdin:

1. Install Datalogic Aladdin™ (v 1.7.0.0.0 or later) on your computer.
2. Connect the scanner you want to program to the computer.
3. Use Device Autodetection to allow Aladdin to search for your reader, or click on Offline Configuration to select the file for your device.
4. After the Configuration screen opens, click on the music icon in the menu bar in the upper right-hand part of the screen:

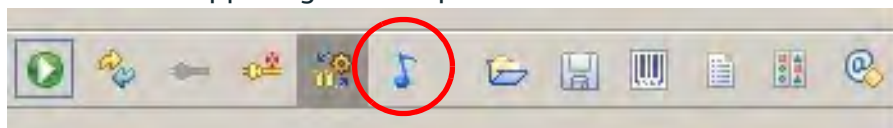

You will be prompted to specify a sound file to upload. The supported format of audio files is WAV uncompressed PCM. Best quality is obtained using stereo audio files with 16 bit encoding.

Up to 15 jingles can be uploaded and programmed.



Audio Jingle Enable

This option determines whether the scanner will sound predefined “Jingles” (a short, user-defined tune uploaded via Datalogic Aladdin™ configuration software) or traditional beep sounds to indicate good read.

See below for parameters to define which preloaded Jingle to sound upon power-up or good read events. Additional items such as enter stand mode, exit stand mode, and error beep can also be programmed using Datalogic Aladdin.

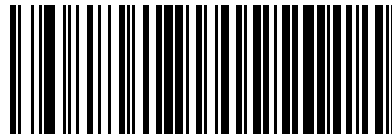
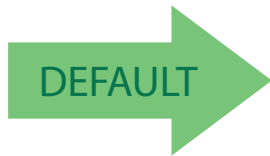

Audio Jingle = Disable (Use traditional beep sounds)

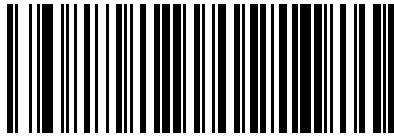

Audio Jingle = Enable Jingles

Select Audio Jingle for Power-up Event

Selects which preloaded Jingle to use to indicate scanner power-up.



Audio Jingles must be enabled (using the previous option) for this selection to take effect.

After uploading up to fifteen (15) Jingles to the scanner using the Datalogic Aladdin™ configuration utility, use this setting to specify which of the Jingles (1-15) or the built-in sound will be used to indicate scanner power-up. The built-in (default) sound for power-up is Dialtone.wav.

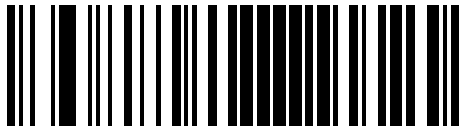
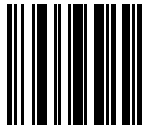
 Select Audio Jingle on Power-up	To configure this feature, scan the ENTER/EXIT bar code above, then the bar code at left followed by two digits from the Alphanumeric characters in Appendix D, Keypad representing the desired Jingle #. End by scanning the ENTER/EXIT bar code again.
Make a mistake? Scan the CANCEL bar code to abort and not save the entry string. You can then start again at the beginning.	 CANCEL

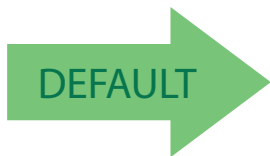

00 = Use built-in power-up sound



Select Audio Jingle for Good Read Event

This parameter selects which preloaded Jingle to use in indicating a good read event.



"Audio Jingle Enable" on page 66 must be selected for this configuration item to take effect.

NOTE

After uploading up to fifteen (15) Jingles to the scanner using the Datalogic Aladdin™ configuration utility, use this setting to designate which of the Jingles (1–15) will be sounded when the scanner performs a good read.



Select Audio Jingle on Good Read

To configure this feature, scan the ENTER/EXIT bar code above, then the bar code at left followed by two digits from the Alphanumeric characters in [Appendix D, Keypad](#) representing the desired Jingle #. End by scanning the ENTER/EXIT bar code again.

Make a mistake? Scan the CANCEL bar code to abort and not save the entry string. You can then start again at the beginning.

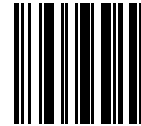

CANCEL

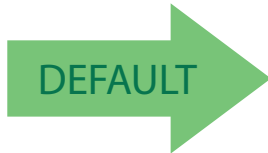

00 = Use built-in Good Read Jingle (Shutter.wav)

Select Audio Jingle for Enter Stand Mode

This parameter selects which preloaded Jingle to use in indicating an Enter Stand Mode event.



"Audio Jingle Enable" on page 66 must be selected for this configuration item to take effect.

NOTE

After uploading up to fifteen (15) Jingles to the scanner using the Datalogic Aladdin™ configuration utility, use this setting to designate which of the Jingles (1–15) will be sounded when the scanner enters Stand Mode.

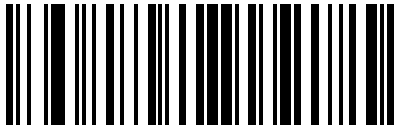
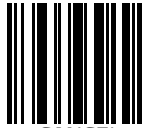
 Select Audio Jingle on Enter Stand Mode	To configure this feature, scan the ENTER/EXIT bar code above, then the bar code at left followed by two digits from the Alphanumeric characters in Appendix D, Keypad representing the desired Jingle #. End by scanning the ENTER/EXIT bar code again.
Make a mistake? Scan the CANCEL bar code to abort and not save the entry string. You can then start again at the beginning.	 CANCEL

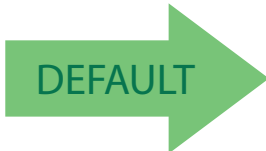

00 = Use built-in Enter Stand Mode indication



Select Audio Jingle for Exit Stand Mode

This parameter selects which preloaded Jingle to use in indicating an Exit Stand Mode event.



"Audio Jingle Enable" on page 66 must be selected for this configuration item to take effect.

NOTE

After uploading up to fifteen (15) Jingles to the scanner using the Datalogic Aladdin™ configuration utility, use this setting to designate which of the Jingles (1–15) will be sounded when the scanner exits Stand Mode.

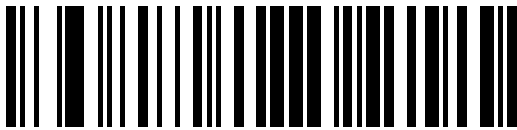

Select Audio Jingle on Exit Stand Mode

To configure this feature, scan the ENTER/EXIT bar code above, then the bar code at left followed by two digits from the Alphanumeric characters in [Appendix D, Keypad](#) representing the desired Jingle #. End by scanning the ENTER/EXIT bar code again.

Make a mistake? Scan the CANCEL bar code to abort and not save the entry string. You can then start again at the beginning.



CANCEL

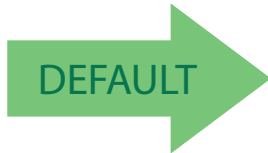

00 = Use built-in Exit Stand Mode indication

Select Audio Jingle for Transmit Error Sound



This parameter selects which preloaded Jingle to use to indicate a Transmit Error sound.



"Audio Jingle Enable" on page 66 must be selected for this configuration item to take effect.

NOTE

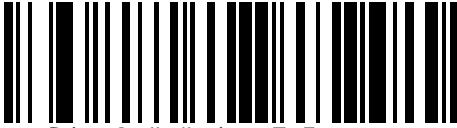
After uploading up to fifteen (15) Jingles to the scanner using the Datalogic Aladdin™ configuration utility, use this setting to designate which of the Jingles (1–15) will be sounded when the scanner performs a good read.

 Select Audio Jingle on Tx Error event	To configure this feature, scan the ENTER/EXIT bar code above, then the bar code at left followed by two digits from the Alphanumeric characters in Appendix D, Keypad representing the desired Jingle #. End by scanning the ENTER/EXIT bar code again.
Make a mistake? Scan the CANCEL bar code to abort and not save the entry string. You can then start again at the beginning.	 CANCEL

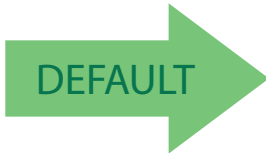

00 = Use built-in Transmit Error Sound indication



Good Read: When to Indicate

This feature specifies when the scanner will provide indication (beep or Jingle and/or LED) upon successfully reading a bar code. Choices are:

- Good Read = Indicate after decode
- Good Read = Indicate after transmit
- Good Read = Indicate after CTS goes inactive, then active



This option, which uses CTS, is only valid for RS-232 interfaces.

NOTE

	 Indicate Good Read = After Decode
 Indicate Good Read = After Transmit	
	 Indicate Good Read = After CTS Goes Inactive, Then Active

Good Read Beep Type

Specifies whether the good read beep has a mono or bitonal beep sound.

	 Good Read Beep Type = Mono
 Good Read Beep Type = Bitonal	

Good Read Beep Frequency

Adjusts the good read beep to sound at a selectable low, medium or high frequency, selectable from the list below. (Controls the speaker's pitch/tone.)

	 Good Read Beep Frequency = Low
 Good Read Beep Frequency = Medium	
	 Good Read Beep Frequency = High







Good Read Speaker Volume

Selects the speaker volume (loudness) upon a good read jingle or beep. There are three selectable volume levels.

	 <p>Good Read Speaker Volume = Speaker Off</p>
 <p>Good Read Speaker Volume = Low</p>	
	 <p>Good Read Speaker Volume = Medium</p>
 <p>Good Read Speaker Volume = High</p>	

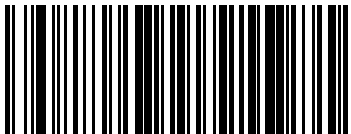
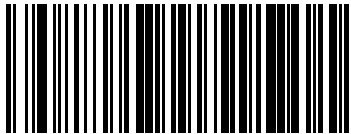
Good Read Beep Length

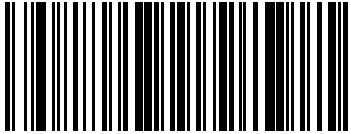
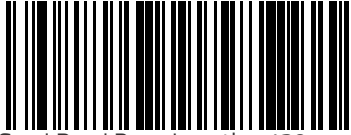
Specifies the duration of a good read beep.

	 Good Read Beep Length = 60 msec
 Good Read Beep Length = 80 msec	
	 Good Read Beep Length = 100 msec
 Good Read Beep Length = 120 msec	
	 Good Read Beep Length = 140 msec
 Good Read Beep Length = 160 msec	



Good Read Beep Length (continued)

	 Good Read Beep Length = 180 msec
 Good Read Beep Length = 200 msec	

RGB LED Settings

The following configuration Items specify settings for the RGB (Red Green Blue) LEDs, which are used to indicate Good Read and Auto Presentation Mode (colors change when Scanner is in Idle mode).

Enable/Disable RGB LED

Enable/Disable RGB LED as a good read indicator..

	 RGB LED = Disable
 RGB LED = Enable	

Good Read LED Color

Specifies the color of the RGB Good Read LED.

	 Good Read LED Color = Red
 Good Read LED Color = Green	
	 Good Read LED Color = Blue

RGB Good Read Raising Time

Specifies the time it will take for the RGB good read to change the status from an Off state to Brightness state.

See "RGB Good Read Raising/Falling Time" on page 238 for more detailed programming instructions.

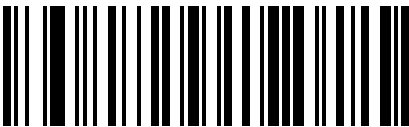
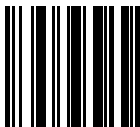
 Set RGB Good Read Raising Time	To configure this feature, scan the ENTER/EXIT bar code above, then the bar code at left followed by two digits from the Alphanumeric characters in Appendix D, Keypad representing your desired character(s). End by scanning the ENTER/EXIT bar code again.
Make a mistake? Scan the CANCEL bar code to abort and not save the entry string. You can then start again at the beginning.	 CANCEL



00 = No time



RGB Good Read Falling Time

Specifies the time for the RGB good read to change the status from the Brightness state to the Off state.

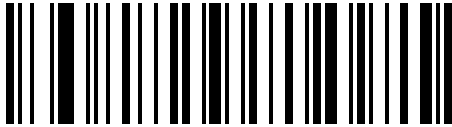
See "RGB Good Read Raising/Falling Time" on page 238 for more detailed programming instructions.



Set RGB Good Read Falling Time

To configure this feature, scan the ENTER/EXIT bar code above, then the bar code at left followed by digits from the Alphanumeric characters in [Appendix D, Keypad](#) representing your desired character(s). End by scanning the ENTER/EXIT bar code again.

Make a mistake? Scan the CANCEL bar code to abort and not save the entry string. You can then start again at the beginning.

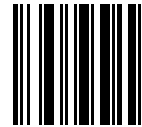

CANCEL

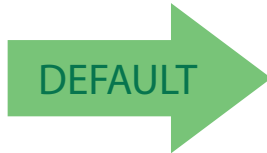

14 = 20 seconds Falling Time

RGB Good Read Holding Time

Specifies how long the RGB good read will stay in Brightness state. See "RGB Good Read Holding Time" on page 239 for more information.

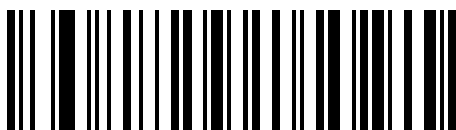

Set RGB Good Read Holding Time

To configure this feature, scan the ENTER/EXIT bar code above, then the bar code at left followed by digits from the Alphanumeric characters in [Appendix D, Keypad](#) representing your desired character(s). End by scanning the ENTER/EXIT bar code again.

Make a mistake? Scan the CANCEL bar code to abort and not save the entry string. You can then start again at the beginning.

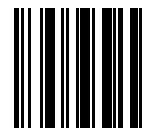

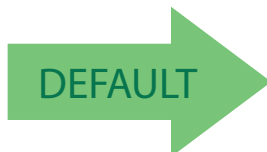

CANCEL



14 = 20 seconds Holding Time

RGB Auto Delay

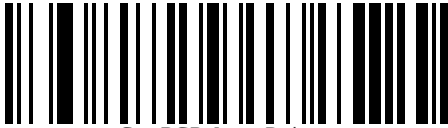
Specifies the delay time for running the RGB auto mode after the scanner has gone into an idle state (no label reading, label programming or communication with Host). The value 0x00 means Auto Mode is disabled. See "RGB Auto Delay Time" on page 240 for more information.

 Set RGB Auto Delay	To configure this feature, scan the ENTER/EXIT bar code above, then the bar code at left followed by digits from the Alphanumeric characters in Appendix D, Keypad representing your desired character(s). End by scanning the ENTER/EXIT bar code again.
Make a mistake? Scan the CANCEL bar code to abort and not save the entry string. You can then start again at the beginning.	 CANCEL

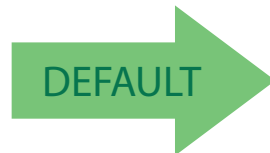

04 = 2 seconds Auto Delay



Scanning Features

Scan Mode

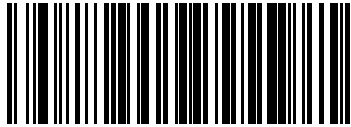
See "Scan Mode" on page 241 for more detailed programming instructions.



Scan Mode = Trigger Single

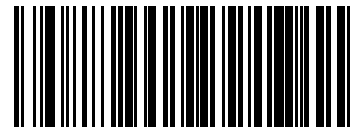

Scan Mode = Trigger Hold Multiple

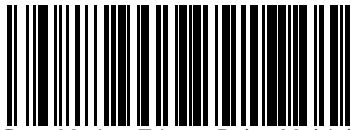

Scan Mode = Trigger Pulse Multiple

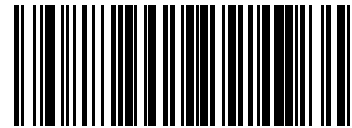

Scan Mode = Flashing

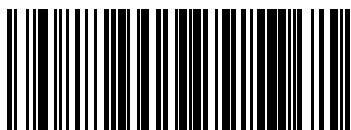

Scan Mode = Always On

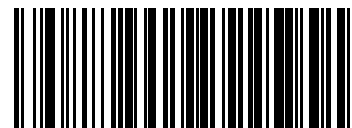





Scan Mode = Stand Mode

Stand Mode Triggered Timeout

This feature specifies the time to remain in “Trigger Single” mode after the trigger is pulled while in “Stand Mode”.

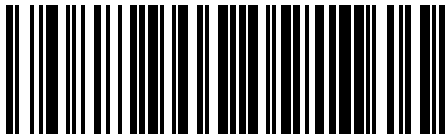
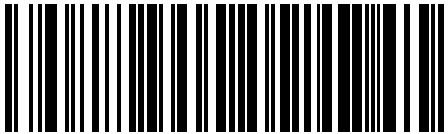
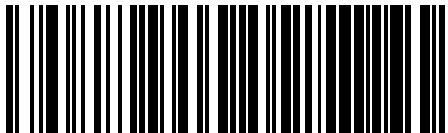

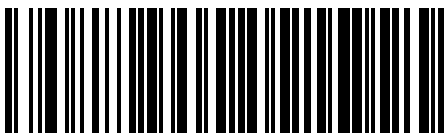
This timeout is only used when the Scan Mode is configured as Stand Mode.

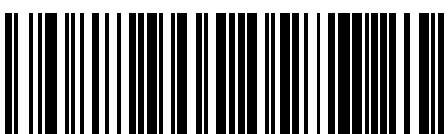
 Stand Mode Triggered Timeout = 0.5 Seconds	
	 Stand Mode Triggered Timeout = 1.5 Seconds
 Stand Mode Triggered Timeout = 2 Seconds	
	 Stand Mode Triggered Timeout = 3 Seconds
 Stand Mode Triggered Timeout = 4 Seconds	
	 Stand Mode Triggered Timeout = 6 Seconds



Stand Mode Triggered Timeout (continued)

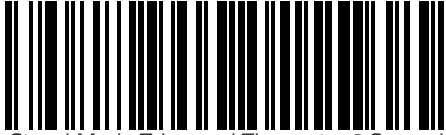

Stand Mode Triggered Timeout = 8 Seconds

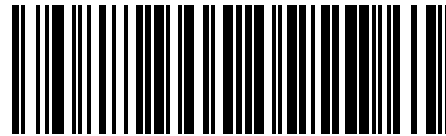

Stand Mode Triggered Timeout = 0
Do Not Switch Back to Stand Mode



NOTE

When set to 0, the scanner will remain in single trigger mode after the trigger is pulled. It will return to object sense mode after a reset.

Scanning Active Time

This setting specifies the amount of time that the reader stays in scan ON state once the state is entered. The range for this setting is from 1 to 255 seconds in 1-second increments. See "Scanning Active Time" on page 242 for more detailed programming instructions.

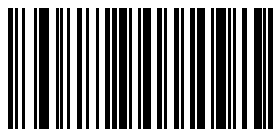

Select Scanning Active Time Setting

To configure this feature, scan the ENTER/EXIT bar code above, then the bar code at left followed by digits from the Alphanumeric characters in [Appendix D, Keypad](#) representing your desired character(s). End by scanning the ENTER/EXIT bar code again.

Make a mistake? Scan the CANCEL bar code to abort and not save the entry string. You can then start again at the beginning.

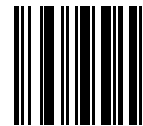

CANCEL

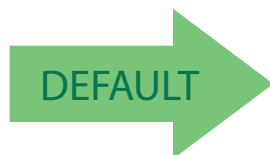

005 = Scanning is active for 5 Seconds



Stand Mode Flash

Enables/disables the LED flash when the reader is in Stand Mode.

	 <p>Stand Mode Flash = Disable</p>
 <p>Stand Mode Flash = Enable</p>	

Flash On Time

This feature specifies the ON time for the indicator LED while in Flash Mode. The selectable range is 100 to 9,900 milliseconds (0.1 to 9.9 seconds), in 100 millisecond increments. See "Flash On Time" on page 243 for more detailed programming instructions.

 <p>Select Flash ON Time Setting</p>	<p>To configure this feature, scan the ENTER/EXIT bar code above, then the bar code at left followed by digits from the Alphanumeric characters in Appendix D, Keypad representing your desired character(s). End by scanning the ENTER/EXIT bar code again.</p>
<p>Make a mistake? Scan the CANCEL bar code to abort and not save the entry string. You can then start again at the beginning.</p>	 <p>CANCEL</p>

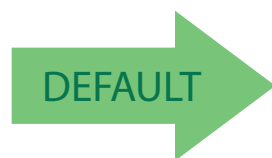

10 = Flash is ON for 1 Second

Flash Off Time

This feature specifies the OFF time for the indicator LED while in Flash Mode. The selectable range is 100 to 9,900 milliseconds (0.1 to 9.9 seconds), in 100 millisecond increments. See "Flash Off Time" on page 244 for more detailed programming instructions.

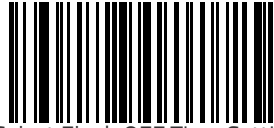
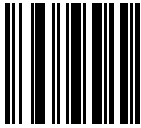

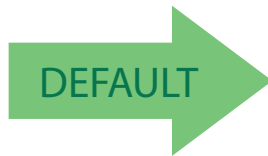
 <p>Select Flash OFF Time Setting</p>	<p>To configure this feature, scan the ENTER/EXIT bar code above, then the bar code at left followed by digits from the Alphanumeric characters in Appendix D, Keypad representing your desired character(s). End by scanning the ENTER/EXIT bar code again.</p>
<p>Make a mistake? Scan the CANCEL bar code to abort and not save the entry string. You can then start again at the beginning.</p>	 <p>CANCEL</p>



06 = Flash is OFF for 600ms

Stand Mode Sensitivity

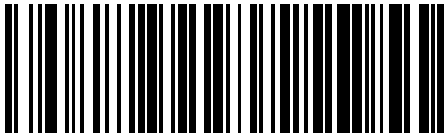
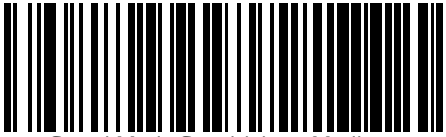
Sets the sensitivity level for stand mode wakeup. Choices are low, medium and high.

	 <p>Stand Mode Sensitivity = Low</p>
 <p>Stand Mode Sensitivity = Medium</p>	
	 <p>Stand Mode Sensitivity = High</p>

Symbologies

Introduction

The scanner supports the following symbologies (bar code types). Options for each symbology are included in this chapter.

UPC-A on page 87	Datalogic 2 of 5 on page 146
UPC-E on page 90	Codabar on page 153
EAN 13 on page 93	ABC Codabar on page 164
EAN 13 on page 93 (JAN 13)	Code 11 on page 166
EAN 8 on page 96 (JAN 8)	Standard 2 of 5 on page 174
Add-Ons on page 101	Industrial 2 of 5 on page 179
GS1 DataBar™ Omnidirectional on page 105	IATA on page 184
GS1 DataBar™ Expanded on page 107	ISBT 128 on page 185
GS1 DataBar™ Limited on page 111	MSI on page 188
Code 39 on page 113	Code 93 on page 194
Code 32 (Italian Pharmaceutical) on page 125	Codablock F on page 202
Code 39 CIP (French Pharmaceutical) on page 127	Code 4 on page 206
Code 128 on page 127	Code 5 on page 207
GS1-128 on page 136	Follett 2 of 5 on page 211
Interleaved 2 of 5 (I 2 of 5) on page 137	BC412 on page 211
Interleaved 2 of 5 CIP HR on page 145	

Standard Factory Settings for Symbologies

Default settings are indicated at each feature/option with a green arrow. Also reference [Appendix B, Standard Defaults](#) for a listing of the most widely used set of standard factory settings. That section also provides space to record any custom settings needed or implemented for your system.



Disable All Symbologies

Scan this label to disable all symbologies.

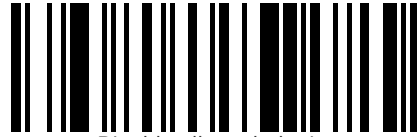

Disable all symbologies

Coupon Control

This feature is used to control the method of processing coupon labels.

Options are:

- Allow all — allow all coupon bar codes to be decoded
- Enable only UPC/EAN — enables only UPC/EAN coupon decoding
- Enable only GS1 DataBar — enables only GS1 DataBar coupon decoding

To set this feature:

1. Scan the Enter/Exit bar code.
2. Scan either the enable or disable bar code below. You'll need to cover any unused bar codes on this and the facing page to ensure that the scanner sees only the bar code you intend to scan.
3. Complete the programming sequence by scanning the Enter/Exit bar code.

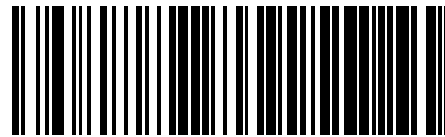

Coupon Control = Allow all

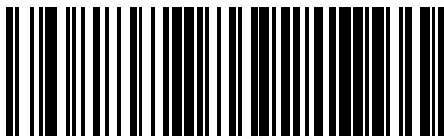

Coupon Control = Enable only UPC/EAN

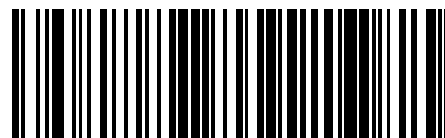

Coupon Control = Enable only GS1 DataBar

UPC-A

The following options apply to the UPC-A symbology.



UPC-A Enable/Disable

When disabled, the scanner will not read UPC-A bar codes.

	 UPC-A = Disable
 UPC-A = Enable	

UPC-A Check Character Transmission

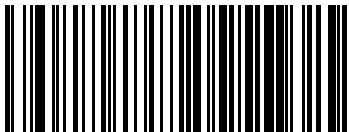
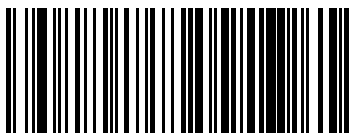
Enable this option to transmit the check character along with UPC-A bar code data.

	 UPC-A Check Character Transmission = Don't Send
 UPC-A Check Character Transmission = Send	



Expand UPC-A to EAN-13

Expands UPC-A data to the EAN-13 data format. Selecting this feature also changes the symbology ID to match those required for EAN-13.

	<p>UPC-A to EAN-13 = Don't Expand</p>
<p>UPC-A to EAN-13 = Expand</p>	

UPC-A Number System Character Transmission

This feature enables/disables transmission of the UPC-A number system character.

	<p>UPC-A Number System Character = Do not transmit</p>
<p>UPC-A Number System Character = Transmit</p>	

In-Store Minimum Reads

This feature specifies the minimum number of consecutive times an in-store label must be decoded before it is accepted as good read.

In-store labels are defined as UPC-A labels with a number-system character of 2 or 4 as well as EAN 8 and EAN 13 labels with a Flag1 character of 2 or an EAN 13 label starting with the three characters '980'.

	 In-Store Minimum Reads = 1
 In-Store Minimum Reads = 2	
	 In-Store Minimum Reads = 3
 In-Store Minimum Reads = 4	





UPC-E

The following options apply to the UPC-E symbology.

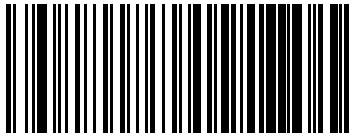

UPC-E Enable/Disable

When disabled, the scanner will not read UPC-E bar codes.

	 <p>UPC-E = Disable</p>
 <p>UPC-E = Enable</p>	

UPC-E Check Character Transmission

Enable this option to transmit the check character along with UPC-E bar code data.

	 <p>UPC-E Check Character Transmission = Don't Send</p>
 <p>UPC-E Check Character Transmission = Send</p>	

Expand UPC-E to EAN-13

Expands UPC-E data to the EAN-13 data format. Selecting this feature also changes the symbology ID to match those required for EAN-13.

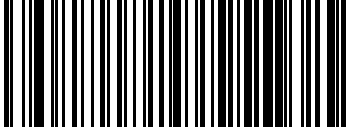
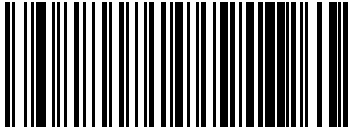
	 UPC-E to EAN-13 = Don't Expand
 UPC-E to EAN-13 = Expand	

Expand UPC-E to UPC-A



Expands UPC-E data to the UPC-A data format.

	 UPC-E to UPC-A = Don't Expand
 UPC-E to UPC-A = Expand	





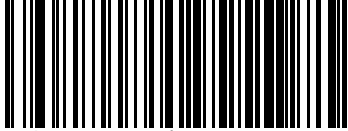
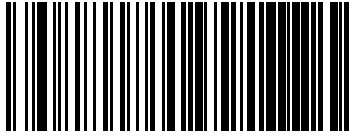

UPC-E Number System Character Transmission

This feature enables/disables transmission of the UPC-E system number character.

	 UPC-E Number System Character = Do not transmit
 UPC-E Number System Character = Transmit	

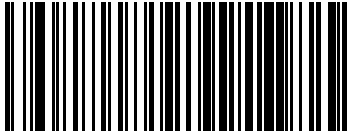
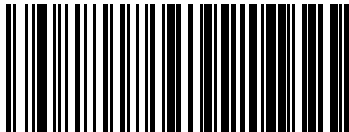
UPC-E Minimum Read

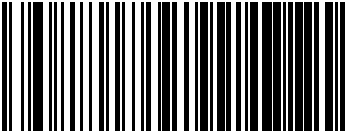
This feature specifies the minimum number of consecutive times a UPC-E label must be decoded before it is accepted as good read.

	 UPC-E Minimum Reads = 1
 UPC-E Minimum Reads = 2	
	 UPC-E Minimum Reads = 3
 UPC-E Minimum Reads = 4	

EAN 13

The following options apply to the EAN 13 (Jan 13) symbology.



EAN 13 Enable/Disable

When disabled, the scanner will not read EAN 13/JAN 13 bar codes.

	 EAN 13 = Disable
 EAN 13 = Enable	

EAN 13 Check Character Transmission

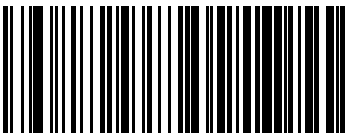
Enable this option to transmit the check character along with EAN 13 bar code data.

	 EAN 13 Check Character Transmission = Don't Send
 EAN 13 Check Character Transmission = Send	



EAN-13 Flag 1 Character

Enables/disables transmission of an EAN/JAN13 Flag1 character. The Flag 1 character is the first character of the label.

	 <p>EAN-13 Flag 1 Char= Don't transmit</p>
 <p>EAN-13 Flag 1 Char= Transmit</p>	

EAN-13 ISBN Conversion

This option enables/disables conversion of EAN 13/JAN 13 Bookland labels starting with 978 to ISBN labels.

	 <p>EAN-13 ISBN Conversion = Disable</p>
 <p>EAN-13 ISBN Conversion = Convert to ISBN</p>	

ISSN Enable/Disable

Enables/disables conversion of EAN/JAN13 Bookland labels starting with 977 to ISSN labels.

	 <p>ISSN = Disable</p>
 <p>ISSN = Enable</p>	

EAN 13 Minimum Reads

This feature specifies the minimum number of consecutive times an EAN 13 label must be decoded before it is accepted as good read.

	 <p>EAN 13 Minimum Reads = 1</p>
 <p>EAN 13 Minimum Reads = 2</p>	
	 <p>EAN 13 Minimum Reads = 3</p>
 <p>EAN 13 Minimum Reads = 4</p>	



EAN 8

The following options apply to the EAN 8 (Jan 8) symbology.



EAN 8 Enable/Disable

When disabled, the scanner will not read EAN 8/JAN 8 bar codes.

	 EAN 8 = Disable
 EAN 8 = Enable	

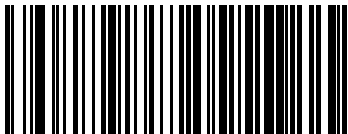
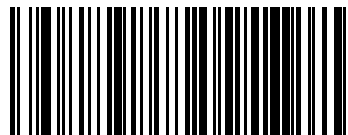

EAN 8 Check Character Transmission

Enable this option to transmit the check character along with EAN 8 bar code data.

	 EAN 8 Check Character Transmission = Don't Send
 EAN 8 Check Character Transmission = Send	

Expand EAN 8 to EAN 13

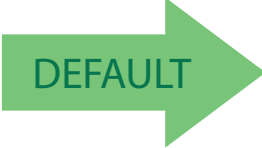
Enable this option to expand EAN 8/JAN 8 labels to EAN 13/JAN 13.

	 <p>Expand EAN 8 to EAN 13 = Disable</p>
 <p>Expand EAN 8 to EAN 13 = Enable</p>	

EAN 8 Minimum Reads

This feature specifies the minimum number of consecutive times an EAN 8 (Jan 8) label must be decoded before it is accepted as good read.

	 <p>EAN 8 Minimum Reads = 1</p>
 <p>EAN 8 Minimum Reads = 2</p>	
 <p>EAN 8 Minimum Reads = 3</p>	 <p>EAN 8 Minimum Reads = 3</p>
 <p>EAN 8 Minimum Reads = 4</p>	



UPC/EAN Global Settings

This section provides configuration settings for UPC-A, UPC-E, EAN 13 and EAN 8 symbologies, and affects all of these unless otherwise marked for each feature description.

UPC/EAN Decoding Level

Decoding Levels are used to configure a bar code symbology decoder to be very aggressive to very conservative depending on a particular customer's needs. See "Decoding Levels" on page 245 for more detailed programming instructions.

 <p>UPC/EAN Decoding Level = 1</p>	
	 <p>UPC/EAN Decoding Level = 2</p>
 <p>UPC/EAN Decoding Level = 3</p>	
	 <p>UPC/EAN Decoding Level = 4</p>
 <p>UPC/EAN Decoding Level = 5</p>	

UPC/EAN Price Weight Check

This feature enables/disables calculation and verification of price/weight check digits.

Options are

- Disabled
- Enable 4-digit price-weight check-digit calculation
- Enable 5-digit price-weight check-digit calculation
- Enable European 4-digit price-weight check-digit calculation
- Enable European 5-digit price-weight check-digit calculation

	 Price Weight Check = Disabled
 Price Weight Check = 4-digit price-weight check	
 Price Weight Check = 5-digit price-weight check	 Price Weight Check = 5-digit price-weight check
 Price Weight Check = European 4-digit price-weight check	
 Price Weight Check = European 5-digit price-weight check	 Price Weight Check = European 5-digit price-weight check



UPC-A Minimum Reads

This feature specifies the minimum number of consecutive times a UPC-A label must be decoded before it is accepted as good read.

Add-Ons

The following features apply to optional add-ons.



NOTE

Contact Customer Support for advanced programming of optional and conditional add-ons.

Optional Add-ons

The scanner can be enabled to optionally read the following add-ons (supplementals):

- P2
- P5



NOTE

If a UPC/EAN base label and an add-on are both decoded, the scanner will transmit the base label and add-on. If a UPC/EAN base label is decoded without an add-on, the base label will be transmitted without an add-on.

Conditional add-on settings (if enabled) are considered by the scanner before optional add-on settings.

	 <p>Optional Add-Ons = Disable P2</p>
 <p>Optional Add-Ons = Enable P2</p>	
	 <p>Optional Add-Ons = Disable P5</p>
 <p>Optional Add-Ons = Enable P5</p>	



Optional Add-On Timer

This option sets the time the scanner will look for an add-on when an add-on fragment has been seen and optional add-ons are enabled.

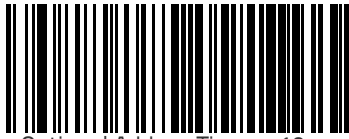

Optional Add-on Timer = 10ms

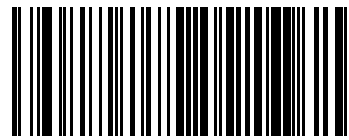

Optional Add-on Timer = 20ms

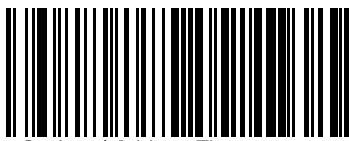

Optional Add-on Timer = 30ms

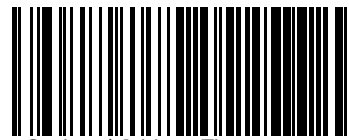

Optional Add-on Timer = 50ms

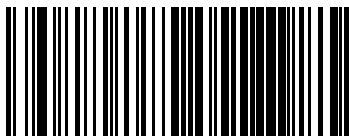

Optional Add-on Timer = 70ms

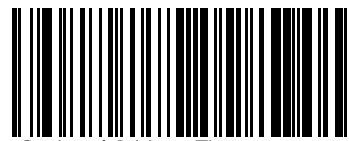

Optional Add-on Timer = 100ms

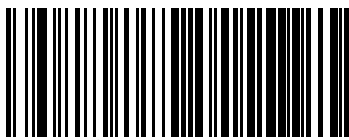

Optional Add-on Timer = 160ms

P2 Add-Ons Minimum Reads

This feature specifies the minimum number of times a P2 add-on must be read before it is marked as valid and then combined with a base label.

	 P2 Add-Ons Minimum Reads = 1
 P2 Add-Ons Minimum Reads = 2	
	 P2 Add-Ons Minimum Reads = 3
 P2 Add-Ons Minimum Reads = 4	



P5 Add-Ons Minimum Reads

This feature specifies the minimum number of times a P5 add-on must be read before it is marked as valid and then combined with a base label.

	 P5 Add-Ons Minimum Reads = 1
 P5 Add-Ons Minimum Reads = 2	
	 P5 Add-Ons Minimum Reads = 3
 P5 Add-Ons Minimum Reads = 4	

GS1 DataBar™ Omnidirectional

The following options apply to the GS1 DataBar Omnidirectional (formerly RSS-14) symbology.

GS1 DataBar Omnidirectional Enable/Disable

When disabled, the scanner will not read GS1 DataBar Omnidirectional bar codes.

	 GS1 DataBar Omnidirectional = Disable
 GS1 DataBar Omnidirectional = Enable	

GS1 DataBar Omnidirectional GS1-128 Emulation

When enabled, GS1 DataBar Omnidirectional bar codes will be translated to the GS1-128 label data format.

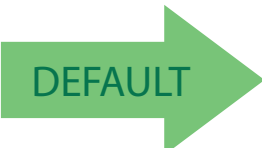
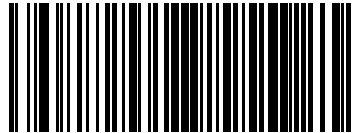
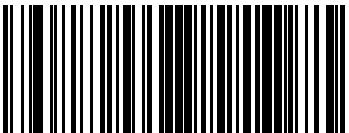
	 GS1 DataBar Omnidirectional GS1-128 Emulation = Disable
 GS1 DataBar Omnidirectional GS1-128 Emulation = Enable	



GS1 DataBar Omnidirectional Minimum Reads

This feature specifies the minimum number of consecutive times a GS1 DataBar Omnidirectional label must be decoded before it is accepted as good read.

	 <p>GS1 DataBar Omnidirectional Minimum Reads = 1</p>
 <p>GS1 DataBar Omnidirectional Minimum Reads = 2</p>	
	 <p>GS1 DataBar Omnidirectional Minimum Reads = 3</p>
 <p>GS1 DataBar Omnidirectional Minimum Reads = 4</p>	

GS1 DataBar™ Expanded

The following options apply to the GS1 DataBar Expanded (formerly RSS Expanded) symbology.

GS1 DataBar Expanded Enable/Disable

When disabled, the scanner will not read GS1 DataBar Expanded bar codes.

	 GS1 DataBar Expanded = Disable
 GS1 DataBar Expanded = Enable	

GS1 DataBar Expanded GS1-128 Emulation

When enabled, GS1 DataBar Expanded bar codes will be translated to the GS1-128 label data format.

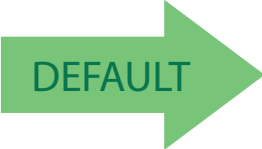
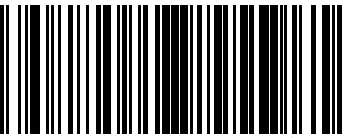
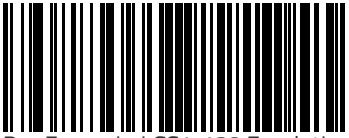
	 GS1 DataBar Expanded GS1-128 Emulation = Disable
 GS1 DataBar Expanded GS1-128 Emulation = Enable	



GS1 DataBar Expanded Minimum Reads

This feature specifies the minimum number of consecutive times a GS1 DataBar Expanded label must be decoded before it is accepted as good read.

	 <p>GS1 DataBar Expanded Minimum Reads = 1</p>
 <p>GS1 DataBar Expanded Minimum Reads = 2</p>	
	 <p>GS1 DataBar Expanded Minimum Reads = 3</p>
 <p>GS1 DataBar Expanded Minimum Reads = 4</p>	

GS1 DataBar Expanded Length Control

This feature specifies either variable length decoding or fixed length decoding for the GS1 DataBar Expanded symbology.

Variable Length: For variable-length decoding, a minimum length may be set.



Fixed Length: For fixed-length decoding, two different lengths may be set.

	 GS1 DataBar Expanded Length Control = Variable Length
 GS1 DataBar Expanded Length Control = Fixed Length	

GS1 DataBar Expanded Set Length 1

This feature specifies one of the bar code lengths for [GS1 DataBar Expanded Length Control on page 109](#). Length 1 is the minimum label length if in [Variable Length on page 109 Mode](#), or the first fixed length if in [Fixed Length on page 109 Mode](#). Length includes the bar code's data characters only.

The length can be set from 1 to 74 characters. See "[Set Length 1](#)" on page 245 for more detailed programming instructions.

 Select GS1 DataBar Expanded Set Length 1 Setting	<p>To configure this feature, scan the ENTER/EXIT bar code above, then the bar code at left followed by digits from the Alphanumeric characters in Appendix D, Key-pad representing your desired character(s). End by scanning the ENTER/EXIT bar code again.</p>
<p>Make a mistake? Scan the CANCEL bar code to abort and not save the entry string. You can then start again at the beginning.</p>	 CANCEL



01 = Length 1 is 1 Character



GS1 DataBar Expanded Set Length 2

This feature specifies one of the bar code lengths for [GS1 DataBar Expanded Length Control on page 109](#). Length 2 is the maximum label length if in [Variable Length on page 109 Mode](#), or the second fixed length if in [Fixed Length on page 109 Mode](#). Length includes the bar code’s data characters only.

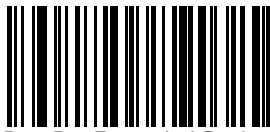
The length can be set from 1 to 74 characters. A setting of 00 specifies to ignore this length (only one fixed length). See ["Set Length 2" on page 247](#) for more detailed programming instructions.



Select GS1 DataBar Expanded Set Length 2 Setting

To configure this feature, scan the ENTER/EXIT bar code above, then the bar code at left followed by digits from the Alphanumeric characters in [Appendix D, Keypad](#) representing your desired character(s). End by scanning the ENTER/EXIT bar code again.

Make a mistake? Scan the CANCEL bar code to abort and not save the entry string. You can then start again at the beginning.

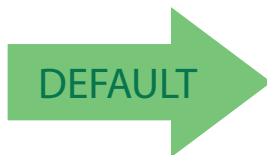

74 = Length 2 is 74 Characters

GS1 DataBar™ Limited

The following options apply to the GS1 DataBar Limited (formerly RSS Limited) symbology.

GS1 DataBar Limited Enable/Disable

When disabled, the scanner will not read GS1 DataBar Limited bar codes.

	 GS1 DataBar Limited = Disable
 GS1 DataBar Limited = Enable	

GS1 DataBar Limited GS1-128 Emulation

When enabled, GS1 DataBar Limited bar codes will be translated to the GS1-128 label data format.

	 GS1 DataBar Limited GS1-128 Emulation = Disable
 GS1 DataBar Limited GS1-128 Emulation = Enable	



GS1 DataBar Limited Minimum Reads

This feature specifies the minimum number of consecutive times a GS1 DataBar Limited label must be decoded before it is accepted as good read.

	 GS1 DataBar Limited Minimum Reads = 1
 GS1 DataBar Limited Minimum Reads = 2	
	 GS1 DataBar Limited Minimum Reads = 3
 GS1 DataBar Limited Minimum Reads = 4	

Code 39

The following options apply to the Code 39 symbology.

Code 39 Enable/Disable

When disabled, the scanner will not read Code 39 bar codes.

	 Code 39 = Disable
 Code 39 = Enable	



Code 39 Check Character Calculation

Enable this option to enable/disable calculation and verification of an optional Code 39 check character. When disabled, any check character in the label is treated as a data character.

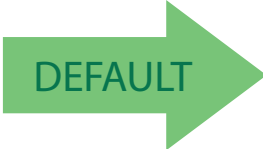
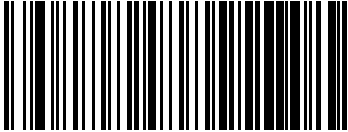
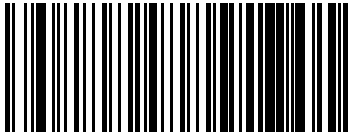
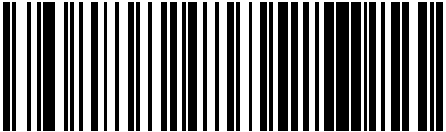
	 Code 39 Check Character Calculation = Don't Calculate
 Code 39 Check Character Calculation = Calculate Std Check	
	 Code 39 Check Character Calculation = Calculate Mod 7 Check
 Code 39 Check Character Calculation = Enable Italian Post Check	
	 Code 39 Check Character Calculation = Enable Daimler Chrysler Check

Code 39 Check Character Transmission

Enable this option to transmit the check character along with Code 39 bar code data.

	 Code 39 Check Character Transmission = Don't Send
 Code 39 Check Character Transmission = Send	

Code 39 Start/Stop Character Transmission

Enable this option to enable/disable transmission of Code 39 start and stop characters.

	 Code 39 Start/Stop Character Transmission = Don't Transmit
 Code 39 Start/Stop Character Transmission = Transmit	



Code 39 Full ASCII

In Code 39 decoding, this enables/disables the translation of Code 39 characters to Code 39 full-ASCII characters.

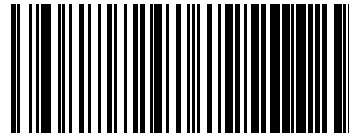
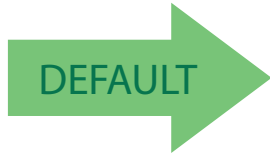

Code 39 Full ASCII = Disable

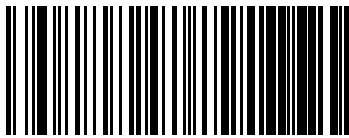

Code 39 Full ASCII = Enable

Code 39 Quiet Zones

This feature specifies the number of quiet zones for Code 39 labels. Quiet zones are blank areas at the ends of a bar code and are typically 10 times the width of the narrowest bar or space in the label.

 Code 39 Quiet Zones = Quiet Zone on one side	
	 Code 39 Quiet Zones = Quiet Zones on two sides
 Code 39 Quiet Zones = Auto	
	 Code 39 Quiet Zones = Virtual Quiet Zones on two sides
 Code 39 Quiet Zones = Small Quiet Zones on two sides	







Code 39 Minimum Reads

This feature specifies the minimum number of consecutive times a Code 39 label must be decoded before it is accepted as good read.

	 Code 39 Minimum Reads = 1
 Code 39 Minimum Reads = 2	
	 Code 39 Minimum Reads = 3
 Code 39 Minimum Reads = 4	

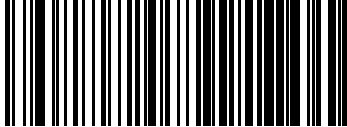
Code 39 Decoding Level

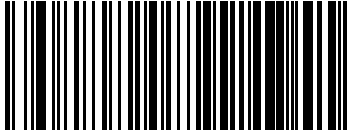
Decoding Levels are used to configure a bar code symbology decoder to be very aggressive to very conservative depending on a particular customer's needs. See "[Decoding Levels](#)" on page 245 for more detailed programming instructions.

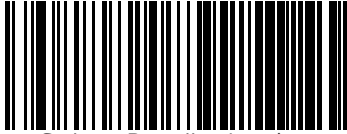
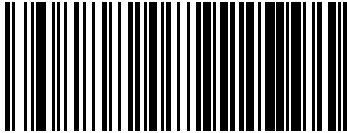
	 Code 39 Decoding Level = Disabled
 Code 39 Decoding Level = 1	
	 Code 39 Decoding Level = 2
 Code 39 Decoding Level = 3	
	 Code 39 Decoding Level = 4
 Code 39 Decoding Level = 5	





Code 39 Length Control

This feature specifies either variable length decoding or fixed length decoding for the Code 39 symbology.

Variable Length: For variable length decoding, a minimum and maximum length may be set.

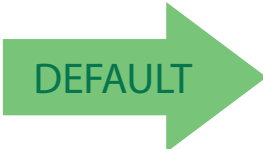
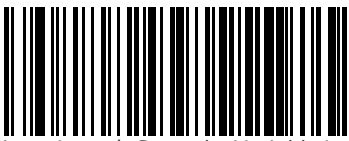
Fixed Length: For fixed length decoding, two different lengths may be set.

	 <p>Code 39 Length Control = Variable Length</p>
 <p>Code 39 Length Control = Fixed Length</p>	

Code 39 Set Length 1

This feature specifies one of the bar code lengths for [Code 39 Length Control on page 120](#). Length 1 is the minimum label length if in [Variable Length on page 120 Mode](#), or the first fixed length if in [Fixed Length on page 120 Mode](#). Length includes the bar code's check, data, and full-ASCII shift characters. The length does not include start/stop characters.

The length can be set from 0 to 50 characters. See ["Set Length 1" on page 245](#) for more detailed programming instructions.

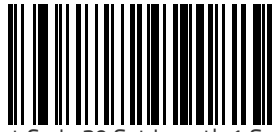

Select Code 39 Set Length 1 Setting

To configure this feature, scan the ENTER/EXIT bar code above, then the bar code at left followed by digits from the Alphanumeric characters in [Appendix D, Keypad](#) representing your desired character(s). End by scanning the ENTER/EXIT bar code again.

Make a mistake? Scan the CANCEL bar code to abort and not save the entry string. You can then start again at the beginning.



DEFAULT

02 = Length 1 is 2 Characters



Code 39 Set Length 2

This feature specifies one of the bar code lengths for **Code 39 Length Control** on page 120. Length 2 is the maximum label length if in **Variable Length** on page 120 Mode, or the second fixed length if in **Fixed Length** on page 120 Mode. Length includes the bar code's check, data, and full-ASCII shift characters. The length does not include start/stop characters.

The length can be set from 1 to 50 characters. A setting of 00 specifies to ignore this length (only one fixed length). See "**Set Length 2**" on page 247 for more detailed programming instructions.



Select Code 39 Length 2 Setting

To configure this feature, scan the ENTER/EXIT bar code above, then the bar code at left followed by digits from the Alphanumeric characters in **Appendix D, Keypad** representing your desired character(s). End by scanning the ENTER/EXIT bar code again.

Make a mistake? Scan the CANCEL bar code to abort and not save the entry string. You can then start again at the beginning.



CANCEL

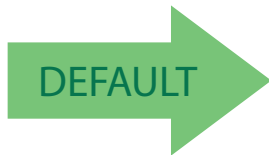

50 = Length 2 is 50 Characters

Code 39 Interdigit Ratio

This feature specifies the ratio between an intercharacter space and module for Code 39 labels.

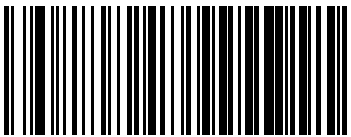
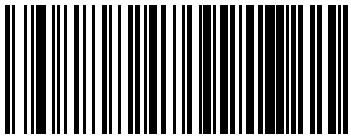
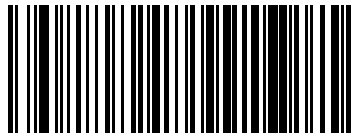
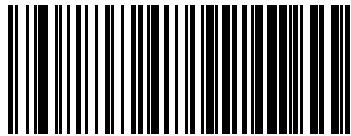
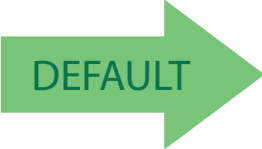
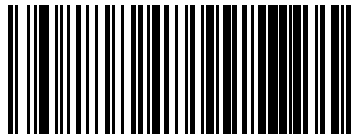
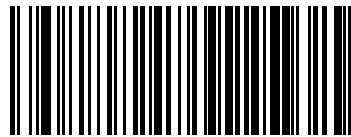
	 Code 39 Interdigit Ratio = Disable
 Code 39 Interdigit Ratio = 1	
	 Code 39 Interdigit Ratio = 2
 Code 39 Interdigit Ratio = 3	
	 Code 39 Interdigit Ratio = 4
 Code 39 Interdigit Ratio = 5	

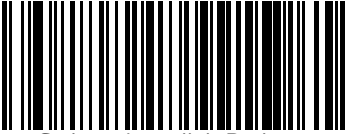
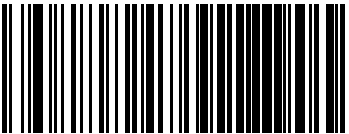
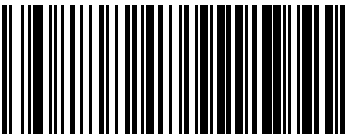
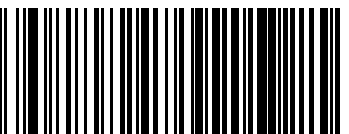
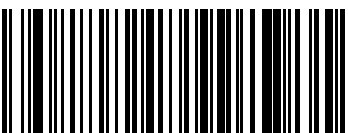

Code 39 Interdigit Ratio (continued)

	 Code 39 Interdigit Ratio = 6
 Code 39 Interdigit Ratio = 7	
	 Code 39 Interdigit Ratio = 8
 Code 39 Interdigit Ratio = 9	
	 Code 39 Interdigit Ratio = 10

Code 39 Stitching

This option enables/disables stitching for Code 39 labels. When parts of a Code 39 bar code are presented to the scanner with this feature enabled, the bar code parts will be assembled by the scanner's software, and the data will be decoded if all bar code proofing requirements are met.

	 Code 39 Stitching = Disable
 Code 39 Stitching = Enable	

Code 32 (Italian Pharmaceutical)

The following options apply to the Code 32 symbology.

Code 32 Enable/Disable

When disabled, the scanner will not read Code 32 bar codes.

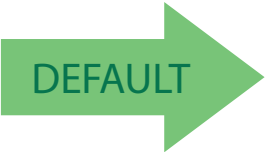
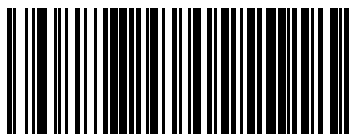
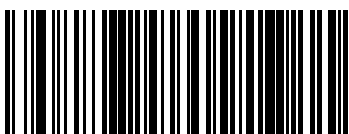
	 Code 32 = Disable
 Code 32 = Enable	



Code 32 Feature Setting Exceptions



NOTE

The following features are set for Code 32 by using these Code 39 settings:

- "Code 39 Quiet Zones" on page 117
- "Code 39 Minimum Reads" on page 118
- "Code 39 Decoding Level" on page 119
- "Code 39 Interdigit Ratio" on page 123
- "Code 39 Stitching" on page 125

Code 32 Check Character Transmission

Enable this option to transmit the check character along with Code 32 bar code data.

	 <p>Code 32 Check Character Transmission = Don't Send</p>
 <p>Code 32 Check Character Transmission = Send</p>	

Code 32 Start/Stop Character Transmission

This option enables/disables transmission of Code 32 start and stop characters.

	 <p>Code 32 Start/Stop Character Transmission = Don't Transmit</p>
 <p>Code 32 Start/Stop Character Transmission = Transmit</p>	

Code 39 CIP (French Pharmaceutical)

The following options apply to the Code 39 CIP symbology.

Code 39 CIP Enable/Disable

Enables/Disables ability of the scanner to decode Code 39 CIP labels.



	 Code 39 CIP = Disable
 Code 39 CIP = Enable	

Code 128

The following options apply to the Code 128 symbology.

Code 128 Enable/Disable

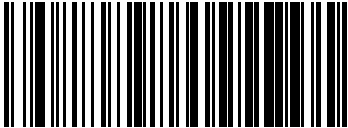
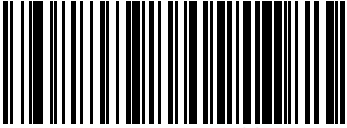
When disabled, the scanner will not read Code 128 bar codes.

	 Code 128 = Disable
 Code 128 = Enable	



Expand Code 128 to Code 39

This feature enables/disables expansion of Code 128 labels to Code 39 labels. When enabled, the label identifier for a Code 128 label shall be set to Code 39 and all Code 39 formatting control shall be applied to the label.

	 Code 128 to Code 39 = Don't Expand
 Code 128 to Code 39 = Expand	

Code 128 Check Character Transmission

Enable this option to transmit the check character along with Code 128 bar code data.

	 Code 128 Check Character Transmission = Don't Send
 Code 128 Check Character Transmission = Send	

Code 128 Function Character Transmission

Enables/disables transmission of Code128 function characters 1, 2, 3, and 4.

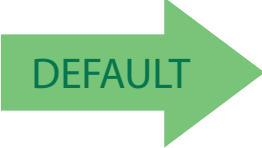
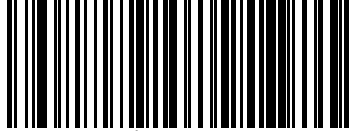
	 Code 128 Function Character Transmission = Don't Send
 Code 128 Function Character Transmission = Send	

Code 128 Sub-Code Change Transmission





Enables/disables the transmission of “Sub-Code exchange” characters (NOT transmitted by standard decoding).

	 Code 128 Sub-Code Change Transmission = Disable
 Code 128 Sub-Code Change Transmission = Enable	

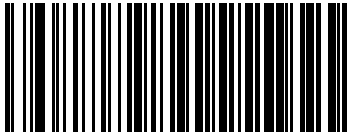
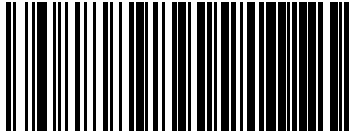

Code 128 Quiet Zones

This feature specifies the number of quiet zones for Code 128 labels. Quiet zones are blank areas at the ends of a bar code and are typically 10 times the width of the narrowest bar or space in the label.

	 <p>Code 128 Quiet Zones = No Quiet Zones</p>
 <p>Code 128 Quiet Zones = Quiet Zone on one side</p>	
	 <p>Code 128 Quiet Zones = Quiet Zones on two sides</p>
 <p>Code 128 Quiet Zones = Auto</p>	
	 <p>Code 128 Quiet Zones = Virtual Quiet Zones on two sides</p>

Code 128 Minimum Reads



This feature specifies the minimum number of consecutive times a Code 128 label must be decoded before it is accepted as good read.

	 Code 128 Minimum Reads = 1
 Code 128 Minimum Reads = 2	
	 Code 128 Minimum Reads = 3
 Code 128 Minimum Reads = 4	

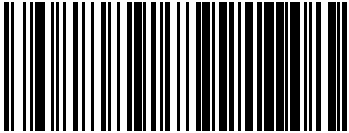
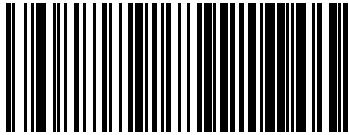
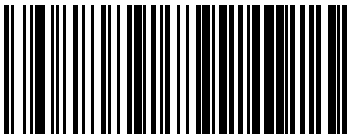

Code 128 Decoding Level

Decoding Levels are used to configure a bar code symbology decoder to be very aggressive to very conservative depending on a particular customer's needs. See "Decoding Levels" on page 245 for more detailed programming instructions.

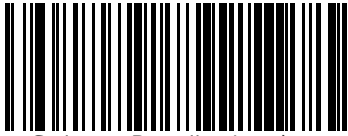
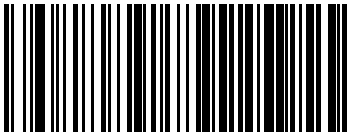
	 <p>Code 128 Decoding Level = Disabled</p>
 <p>Code 128 Decoding Level = 1</p>	
	 <p>Code 128 Decoding Level = 2</p>
 <p>Code 128 Decoding Level = 3</p>	
	 <p>Code 128 Decoding Level = 4</p>
 <p>Code 128 Decoding Level = 5</p>	

Code 128 Length Control

This feature specifies either variable length decoding or fixed length decoding for the Code 128 symbology.

Variable Length: For variable length decoding, a minimum and maximum length may be set.

Fixed Length: For fixed length decoding, two different lengths may be set.

	 Code 128 Length Control = Variable Length
 Code 128 Length Control = Fixed Length	



Code 128 Set Length 1

This feature specifies one of the bar code lengths for **Code 128 Length Control on page 133**. Length 1 is the minimum label length if in **Variable Length on page 133 Mode**, or the first fixed length if in **Fixed Length on page 133 Mode**. Length includes the bar code's data characters only.

The length can be set from 1 to 80 characters. See "**Set Length 1**" on page 245 for more detailed programming instructions.



Select Code 128 Set Length 1 Setting

To configure this feature, scan the ENTER/EXIT bar code above, then the bar code at left followed by digits from the Alphanumeric characters in **Appendix D, Keypad** representing your desired character(s). End by scanning the ENTER/EXIT bar code again.

Make a mistake? Scan the CANCEL bar code to abort and not save the entry string. You can then start again at the beginning.

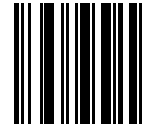

CANCEL

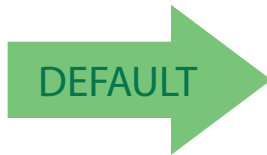

01 = Length 1 is 1 Character

Code 128 Set Length 2

This feature specifies one of the bar code lengths for [Code 128 Length Control on page 133](#). Length 2 is the maximum label length if in [Variable Length on page 133 Mode](#), or the second fixed length if in [Fixed Length on page 133 Mode](#). Length includes the bar code's data characters only.

The length can be set from 1 to 80 characters. A setting of 00 specifies to ignore this length (only one fixed length). See ["Set Length 2" on page 247](#) for more detailed programming instructions.

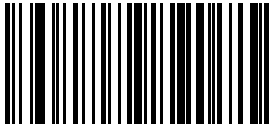
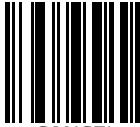
 Select Code 128 Length 2 Setting	<p>To configure this feature, scan the ENTER/EXIT bar code above, then the bar code at left followed by digits from the Alphanumeric characters in Appendix D, Key-pad representing your desired character(s). End by scanning the ENTER/EXIT bar code again.</p>
<p>Make a mistake? Scan the CANCEL bar code to abort and not save the entry string. You can then start again at the beginning.</p>	 CANCEL

80 = Length 2 is 80 Characters

Code 128 Stitching

This option enables/disables stitching for Code 128 labels. When parts of a Code 128 bar code are presented to the scanner with this feature enabled, the bar code parts will be assembled by the scanner's software, and the data will be decoded if all bar code proofing requirements are met.

	 Code 128 Stitching = Disable
 Code 128 Stitching = Enable	



GS1-128

The following options apply to the GS1-128 symbology. (Also known as USS-128, GTIN-128, UCC-128.)

GS1-128 Enable

This option enables/disables the ability of the scanner to translate GS1-128 labels to the GS1-128 data format. Options are:

- Transmit GS1-128 labels in Code 128 data format.
- Transmit GS1-128 labels in GS1-128 data format.
- Do not transmit GS1-128 labels.

	 <p>GS1-128 = Transmit in Code 128 data format</p>
 <p>GS1-128 = Transmit in GS1-128 data format</p>	
	 <p>GS1-128 = Do not transmit GS1-128 labels</p>

Interleaved 2 of 5 (I 2 of 5)

The following options apply to the I 2 of 5 symbology.



When reading this symbology, the settings for I 2 of 5 Length Control AND I 2 of 5 Check Character Calculation **MUST** be enabled to increase decoding safety.

I 2 of 5 Enable/Disable

When disabled, the scanner will not read I 2 of 5 bar codes.

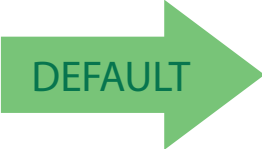
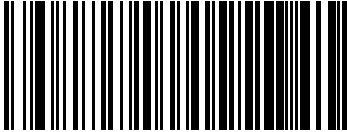
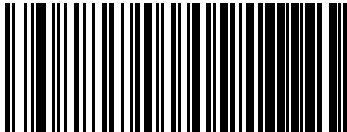
	 <p>I 2 of 5 = Disable</p>
 <p>I 2 of 5 = Enable</p>	



I 2 of 5 Check Character Calculation

This option enables/disables calculation and verification of an optional I 2 of 5 check character.

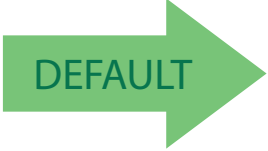
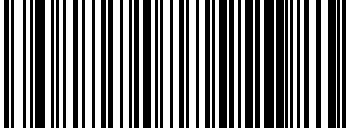
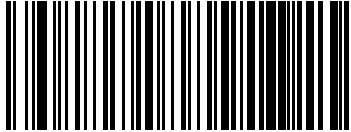
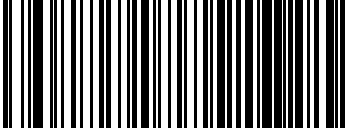
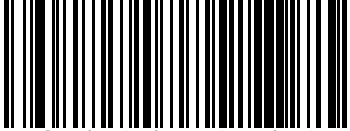
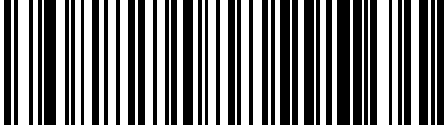
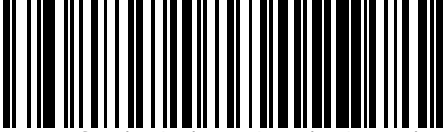
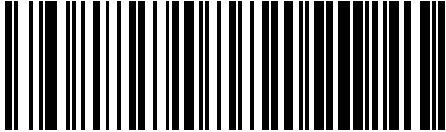
	 <p>I 2 of 5 Check Char Calc = Disable</p>
 <p>I 2 of 5 Check Char Calc = Check Standard (Modulo 10)</p>	
	 <p>I 2 of 5 Check Char Calc = Check German Parcel</p>
 <p>I 2 of 5 Check Char Calc = Check DHL</p>	
	 <p>I 2 of 5 Check Char Calc = Check Daimler Chrysler</p>
 <p>I 2 of 5 Check Char Calc = Check Bosch</p>	
	 <p>I 2 of 5 Check Character Calculation = Check Italian Post</p>

When disabled, any check character in label is treated as a data character.

I 2 of 5 Check Character Transmission

Enable this option to transmit the check character along with I 2 of 5 bar code data.



This feature is valid only when I 2 of 5 Check Character Calculation is enabled.

NOTE

	 I 2 of 5 Check Character Transmission = Don't Send
 I 2 of 5 Check Character Transmission = Send	



I 2 of 5 Minimum Reads

This feature specifies the minimum number of consecutive times an I 2 of 5 label must be decoded before it is accepted as good read.

	 <p>I 2 of 5 Minimum Reads = 1</p>
 <p>I 2 of 5 Minimum Reads = 2</p>	
	 <p>I 2 of 5 Minimum Reads = 3</p>
 <p>I 2 of 5 Minimum Reads = 4</p>	



I 2 of 5 Decoding Level



NOTE

This configuration item applies to Interleaved 2 of 5, Datalogic 2 of 5 and Standard 2 of 5.

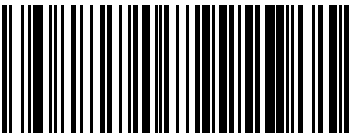
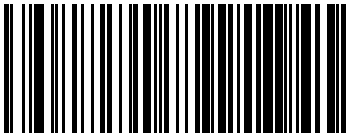
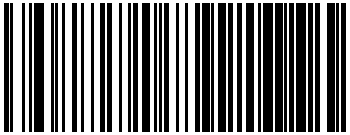
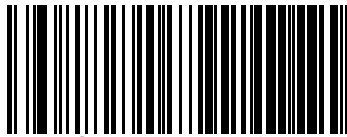
Decoding Levels are used to configure a bar code symbology decoder to be very aggressive to very conservative depending on a particular customer's needs. See "Decoding Levels" on page 245 for more detailed programming instructions.

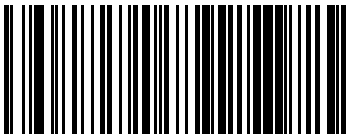
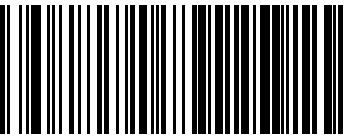
	 2 of 5 Decoding Level = Disabled
 2 of 5 Decoding Level = 1	
	 2 of 5 Decoding Level = 2
 2 of 5 Decoding Level = 3	
	 2 of 5 Decoding Level = 4
 2 of 5 Decoding Level = 5	



I 2 of 5 Length Control

This feature specifies either variable length decoding or fixed length decoding for the I 2 of 5 symbology.

Variable Length: For variable length decoding, a minimum and maximum length may be set.

Fixed Length: For fixed length decoding, two different lengths may be set.

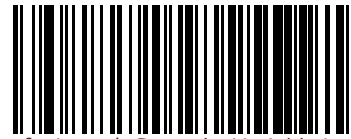
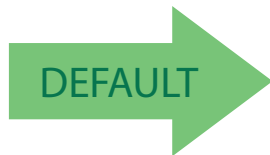

I 2 of 5 Length Control = Variable Length



I 2 of 5 Length Control = Fixed Length

I 2 of 5 Set Length 1

This feature specifies one of the bar code lengths for I 2 of 5 Length Control on page 142. Length 1 is the minimum label length if in Variable Length on page 148 Mode, or the first fixed length if in Fixed Length on page 148 Mode. The length includes the bar code's check and data characters.

The length can be set from 2 to 50 characters in increments of two. See "Set Length 1" on page 245 for more detailed programming instructions.



To configure this feature, scan the ENTER/EXIT bar code above, then the bar code at left followed by digits from the Alphanumeric characters in [Appendix D, Keypad](#) representing your desired character(s). End by scanning the ENTER/EXIT bar code again.

Make a mistake? Scan the CANCEL bar code to abort and not save the entry string. You can then start again at the beginning.



DEFAULT

06 = Length 1 is 6 Characters



I 2 of 5 Set Length 2

This feature specifies one of the bar code lengths for I 2 of 5 Length Control on page 142. Length 2 is the maximum label length if in Variable Length on page 148 Mode, or the second fixed length if in Fixed Length on page 148 Mode. The length includes the bar code's check and data characters.

The length can be set from 2 to 50 characters. A setting of 0 specifies to ignore this length (only one fixed length). See "Set Length 2" on page 247 for more detailed programming instructions.



To configure this feature, scan the ENTER/EXIT bar code above, then the bar code at left followed by digits from the Alphanumeric characters in Appendix D, Key-pad representing your desired character(s). End by scanning the ENTER/EXIT bar code again.

Make a mistake? Scan the CANCEL bar code to abort and not save the entry string. You can then start again at the beginning.

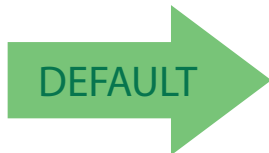

50 = Length 2 is 50 Characters

I 2 of 5 Zero Pattern

Enables/disables ZERO-Digit decoding. This character does not represent any cipher. It allows encoding of an odd number of ciphers with Interleaved 2 of 5. It must be enabled to decode Code 2 of 5 CIP/HR.

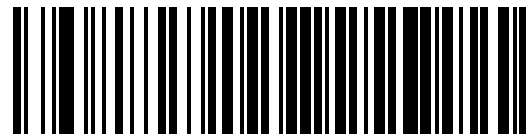

I 2 of 5 Zero Pattern = Disable

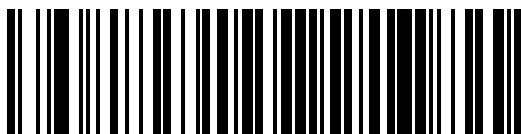

I 2 of 5 Zero Pattern = Enable

Interleaved 2 of 5 CIP HR

The following options apply to the Interleaved 2 of 5 CIP HR symbology.

Interleaved 2 of 5 CIP HR Enable/Disable

Enables/Disables ability of scanner to decode Interleaved 2 of 5 CIP HR labels.



Datalogic 2 of 5

The following options apply to the Datalogic 2 of 5 symbology.

Datalogic 2 of 5 Enable/Disable

When disabled, the scanner will not read Datalogic 2 of 5 bar codes.

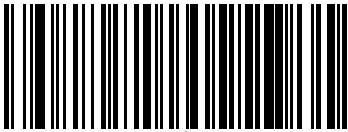
	 Datalogic 2 of 5 = Disable
 Datalogic 2 of 5 = Enable	

Datalogic 2 of 5 Check Character Calculation

This option enables/disables calculation and verification of an optional Datalogic 2 of 5 check character.

	 Datalogic 2 of 5 Check Character Calculation = Disable
 Datalogic 2 of 5 Check Character Calculation = Enable	

Datalogic 2 of 5 Check Character Transmission

This option enables/disables transmission of an optional Datalogic 2 of 5 character.

	 Datalogic 2 of 5 Check Character Transmission = Don't Send
 Datalogic 2 of 5 Check Character Transmission = Send	

Datalogic 2 of 5 Minimum Reads

This feature specifies the minimum number of consecutive times an Datalogic 2 of 5 label must be decoded before it is accepted as good read.

	 1 2 of 5 Minimum Reads = 1
 1 2 of 5 Minimum Reads = 2	
	 1 2 of 5 Minimum Reads = 3
 1 2 of 5 Minimum Reads = 4	



Datalogic 2 of 5 Decoding Level



NOTE

The Datalogic 2 of 5 Decoding Level feature is set using "1 2 of 5 Decoding Level" on page 141.

Datalogic 2 of 5 Length Control

This feature specifies either variable length decoding or fixed length decoding for the Datalogic 2 of 5 symbology.

Variable Length: For variable length decoding, a minimum and maximum length may be set.

Fixed Length: For fixed length decoding, two different lengths may be set.

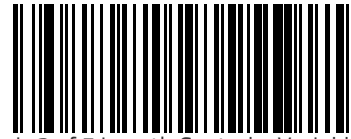
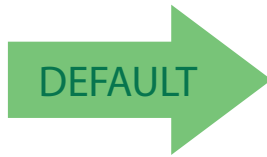

Datalogic 2 of 5 Length Control = Variable Length

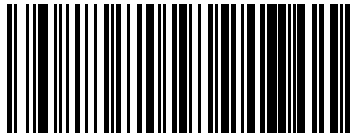

Datalogic 2 of 5 Length Control = Fixed Length

Datalogic 2 of 5 Set Length 1

This feature specifies one of the bar code lengths for [Datalogic 2 of 5 Length Control on page 148](#). Length 1 is the minimum label length if in [Variable Length on page 142 Mode](#), or the first fixed length if in [Fixed Length on page 142 Mode](#). The length includes the bar code's data characters only.

The length can be set from 2 to 50 characters in increments of two. See "[Set Length 1](#)" on page 245 for more detailed programming instructions.



Select Datalogic 2 of 5 Length 1 Setting

To configure this feature, scan the ENTER/EXIT bar code above, then the bar code at left followed by digits from the Alphanumeric characters in [Appendix D, Keypad](#) representing your desired character(s). End by scanning the ENTER/EXIT bar code again.

Make a mistake? Scan the CANCEL bar code to abort and not save the entry string. You can then start again at the beginning.

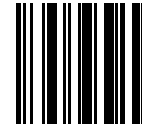

CANCEL

DEFAULT

06 = Length 1 is 6 Characters



Datalogic 2 of 5 Set Length 2

This feature specifies one of the bar code lengths for **Datalogic 2 of 5 Length Control** on page 148. Length 2 is the maximum label length if in **Variable Length** on page 142 Mode, or the second fixed length if in **Fixed Length** on page 142 Mode. The length includes the bar code's data characters only. The length can be set from 2 to 50 characters. A setting of 00 specifies to ignore this length (only one fixed length). See "**Set Length 2**" on page 247 for more detailed programming instructions.



Select Datalogic 2 of 5 Length 2 Setting

To configure this feature, scan the ENTER/EXIT bar code above, then the bar code at left followed by digits from the Alphanumeric characters in **Appendix D, Keypad** representing your desired character(s). End by scanning the ENTER/EXIT bar code again.

Make a mistake? Scan the CANCEL bar code to abort and not save the entry string. You can then start again at the beginning.



CANCEL

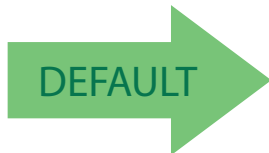

50 = Length 2 is 50 Characters

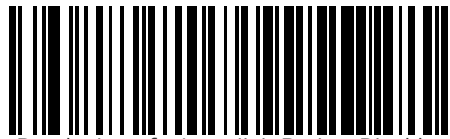
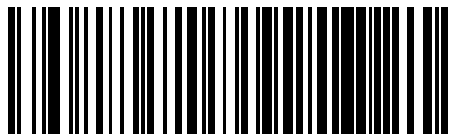
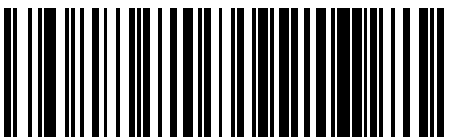
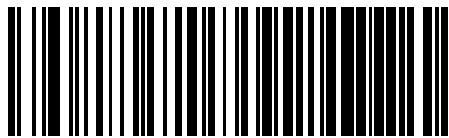
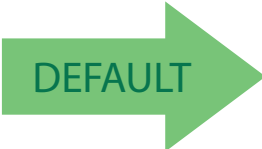
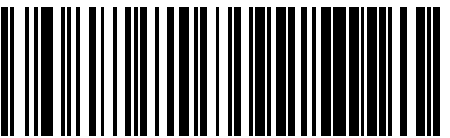
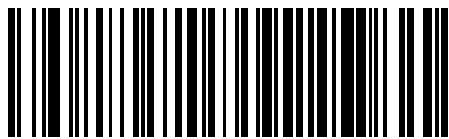

Datalogic 2 of 5 Interdigit Ratio

This feature specifies the maximum ratio between intercharacter space and module for Datalogic 2 of 5.

	 <p>Datalogic 2 of 5 Interdigit Ratio = Disable</p>
 <p>Datalogic 2 of 5 Interdigit Ratio = 1</p>	
	 <p>Datalogic 2 of 5 Interdigit Ratio = 2</p>
 <p>Datalogic 2 of 5 Interdigit Ratio = 3</p>	
	 <p>Datalogic 2 of 5 Interdigit Ratio = 4</p>
 <p>Datalogic 2 of 5 Interdigit Ratio = 5</p>	

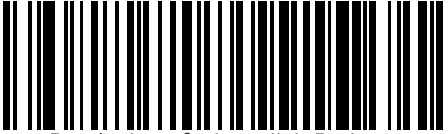
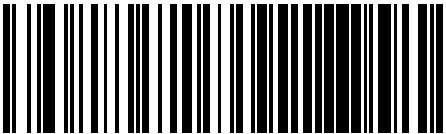
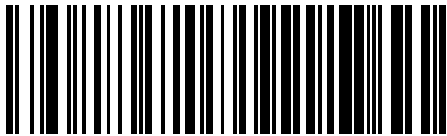
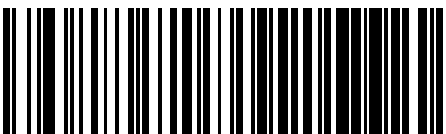

Datalogic 2 of 5 Interdigit Maximum Ratio (continued)

	 <p>Datalogic 2 of 5 Interdigit Ratio = 6</p>
 <p>Datalogic 2 of 5 Interdigit Ratio = 7</p>	
	 <p>Datalogic 2 of 5 Interdigit Ratio = 8</p>
 <p>Datalogic 2 of 5 Interdigit Ratio = 9</p>	
	 <p>Datalogic 2 of 5 Interdigit Ratio = 10</p>

Codabar

The following options apply to the Codabar symbology.

Codabar Enable/Disable

When disabled, the scanner will not read Codabar bar codes.

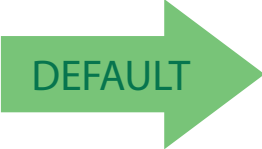
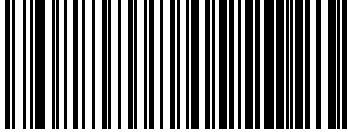
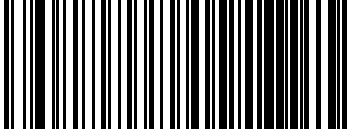
	 <p>Codabar = Disable</p>
 <p>Codabar = Enable</p>	

Codabar Check Character Calculation

Enable this option to enables/disables calculation and verification of an optional Codabar check character. When disabled, any check characters in the label are treated as data characters.

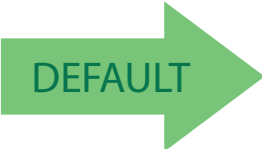
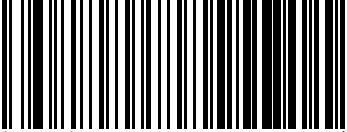
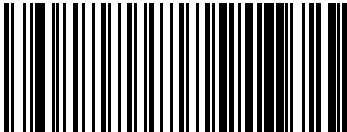
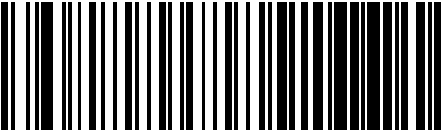
	 <p>Codabar Check Character Calculation = Don't Calculate</p>
 <p>Codabar Check Character Calculation = Enable AIM standard check char.</p>	
	 <p>Codabar Check Character Calculation = Enable Modulo 10 check char.</p>





Codabar Check Character Transmission

Enable this option to transmit the check character along with Codabar bar code data.

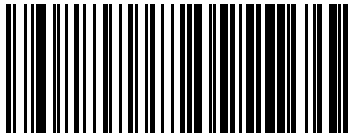
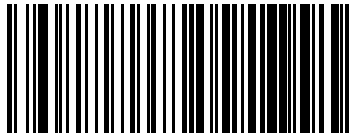

NOTE

This feature is valid only when Codabar Check Character Calculation is enabled.

	 Codabar Check Character Transmission = Don't Send
 Codabar Check Character Transmission = Send	

Codabar Start/Stop Character Transmission

Enable this option to enable/disable transmission of Codabar start and stop characters.

	 Codabar Start/Stop Character Transmission = Don't Transmit
 Codabar Start/Stop Character Transmission = Transmit	

Codabar Start/Stop Character Set

This option specifies the format of transmitted Codabar start/stop characters.

	 Codabar Check Character Set = ABCD/TN*E
 Codabar Check Character Set = ABCD/ABCD	
	 Codabar Check Character Set = abcd/tn*e
 Codabar Check Character Set = abcd/abcd	

Codabar Start/Stop Character Match

When enabled, this option requires that start and stop characters match.

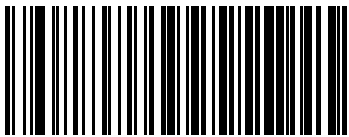
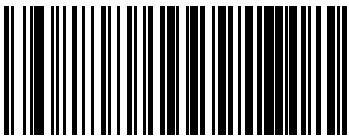
	 Codabar Start/Stop Character Match = Don't Require Match
 Codabar Start/Stop Character Match = Require Match	



Codabar Quiet Zones

This feature specifies the number of quiet zones for Codabar labels. Quiet zones are blank areas at the ends of a bar code and are typically 10 times the width of the narrowest bar or space in the label.

 <p>Codabar Quiet Zones = Quiet Zone on one side</p>	
	 <p>Codabar Quiet Zones = Quiet Zones on two sides</p>
 <p>Codabar Quiet Zones = Auto</p>	
	 <p>Codabar Quiet Zones = Virtual Quiet Zones on two sides</p>
 <p>Codabar Quiet Zones = Small Quiet Zones on two sides</p>	

Codabar Minimum Reads







This feature specifies the minimum number of consecutive times a Codabar label must be decoded before it is accepted as good read.

	 <p>Codabar Minimum Reads = 1</p>
 <p>Codabar Minimum Reads = 2</p>	
	 <p>Codabar Minimum Reads = 3</p>
 <p>Codabar Minimum Reads = 4</p>	

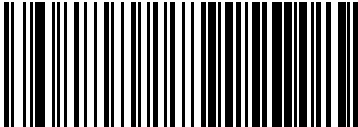
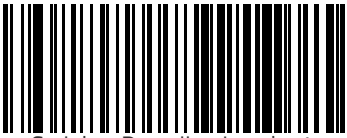

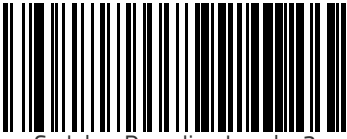
Codabar Decoding Level

Decoding Levels are used to configure a bar code symbology decoder to be very aggressive to very conservative depending on a particular customer's needs. See "Decoding Levels" on page 245 for more detailed programming instructions.



	 Codabar Decoding Level = Disabled
 Codabar Decoding Level = 1	
	 Codabar Decoding Level = 2
 Codabar Decoding Level = 3	
	 Codabar Decoding Level = 4
 Codabar Decoding Level = 5	

Codabar Length Control

This feature specifies either variable length decoding or fixed length decoding for the Codabar symbology.

Variable Length: For variable length decoding, a minimum and maximum length may be set.

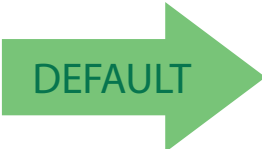
Fixed Length: For fixed length decoding, two different lengths may be set.

	 Codabar Length Control = Variable Length
 Codabar Length Control = Fixed Length	



Codabar Set Length 1

This feature specifies one of the bar code lengths for **Codabar Length Control** on page 159. Length 1 is the minimum label length if in **Variable Length** on page 159 Mode, or the first fixed length if in **Fixed Length** on page 159 Mode. Length includes the bar code's start, stop, check and data characters. The length must include at least one data character.

The length can be set from 3 to 50 characters. See "**Set Length 1**" on page 245 for more detailed programming instructions.

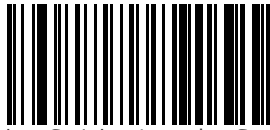

Select Codabar Length 1 Setting

To configure this feature, scan the ENTER/EXIT bar code above, then the bar code at left followed by digits from the Alphanumeric characters in **Appendix D, Keypad** representing your desired character(s). End by scanning the ENTER/EXIT bar code again.

Make a mistake? Scan the CANCEL bar code to abort and not save the entry string. You can then start again at the beginning.

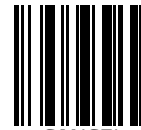

CANCEL



03 = Length 1 is 3 Characters

Codabar Set Length 2

This feature specifies one of the bar code lengths for [Codabar Length Control on page 159](#). Length 2 is the maximum label length if in [Variable Length on page 159 Mode](#), or the second fixed length if in [Fixed Length on page 159 Mode](#). The length includes the bar code's start, stop, check and data characters. The length must include at least one data character.

The length can be set from 3 to 50 characters. A setting of 00 specifies to ignore this length (only one fixed length). See ["Set Length 2" on page 247](#) for more detailed programming instructions.



To configure this feature, scan the ENTER/EXIT bar code above, then the bar code at left followed by digits from the Alphanumeric characters in [Appendix D, Keypad](#) representing your desired character(s). End by scanning the ENTER/EXIT bar code again.

Make a mistake? Scan the CANCEL bar code to abort and not save the entry string. You can then start again at the beginning.







DEFAULT

50 = Length 2 is 50 Characters



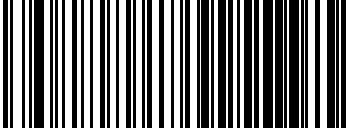
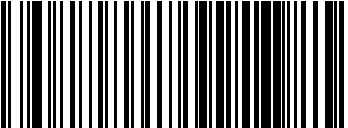
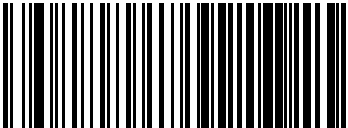
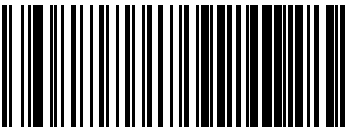

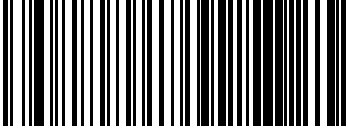
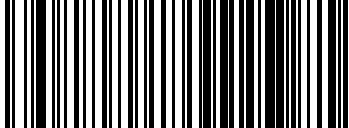
Codabar Interdigit Ratio

This feature specifies the maximum ratio between an intercharacter space and module for Codabar labels.

	 Codabar Interdigit Ratio = Disable
 Codabar Interdigit Ratio = 1	
	 Codabar Interdigit Ratio = 2
 Codabar Interdigit Ratio = 3	
	 Codabar Interdigit Ratio = 4
 Codabar Interdigit Ratio = 5	

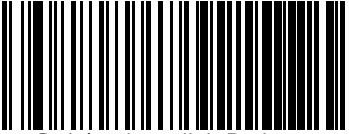
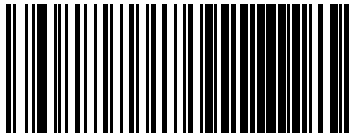
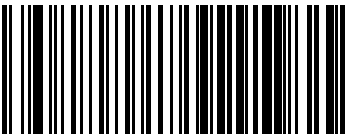
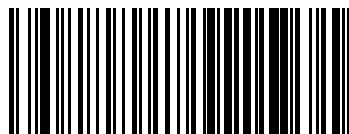
Codabar Interdigit Ratio (continued)

	 <p>Codabar Interdigit Ratio = 6</p>
 <p>Codabar Interdigit Ratio = 7</p>	
	 <p>Codabar Interdigit Ratio = 8</p>
 <p>Codabar Interdigit Ratio = 9</p>	
	 <p>Codabar Interdigit Ratio = 10</p>



ABC Codabar

The following options apply to the ABC Codabar symbology.

ABC Codabar Enable/Disable

Enables/Disables ability of scanner to decode ABC Codabar labels.

	 <p>ABC Codabar = Disable</p>
 <p>ABC Codabar = Enable</p>	



ABC Codabar Concatenation Mode

Specifies the concatenation mode between Static and Dynamic.

	 <p>ABC Codabar Concatenation Mode = Static</p>
 <p>ABC Codabar Concatenation Mode = Dynamic</p>	

ABC Codabar Dynamic Concatenation Timeout

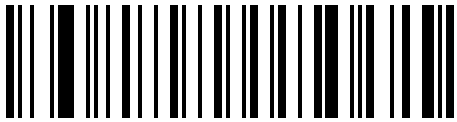
This parameter specifies the timeout in 10–millisecond ticks used by the ABC Codabar Dynamic Concatenation Mode. The timeout can be set within a range of 05 to 255 in 10ms increments. A setting of zero specifies no delay.

 <p>Select ABC Codabar Dynamic Concatenation Timeout Setting</p>	<p>To configure this feature, scan the ENTER/EXIT bar code above, then the bar code at left followed by digits from the Alphanumeric characters in Appendix D, Keypad representing your desired character(s). End by scanning the ENTER/EXIT bar code again.</p>
<p>Make a mistake? Scan the CANCEL bar code to abort and not save the entry string. You can then start again at the beginning.</p>	 <p>CANCEL</p>

 **10 = Quiet Interval of 200 ms**

ABC Codabar Force Concatenation

Forces labels starting or ending with D to be concatenated.

 <p>DEFAULT</p>	 <p>ABC Codabar Force Concatenation = Disable</p>
 <p>ABC Codabar Force Concatenation = Enable</p>	



Code 11

The following options apply to the Code 11 symbology.

Code 11 Enable/Disable

When disabled, the scanner will not read Code 11 bar codes.

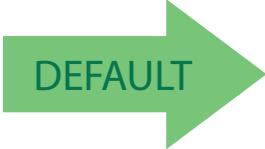
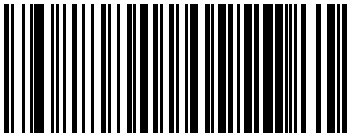
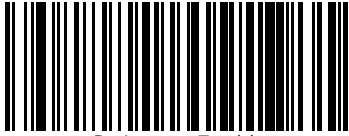
	 Code 11 = Disable
 Code 11 = Enable	

Code 11 Check Character Calculation

This option enables/disables calculation and verification of optional Code 11 check character.

	 Code 11 Check Character Calculation = Disable
 Code 11 Check Character Calculation = Check C	
	 Code 11 Check Character Calculation = Check K
 Code 11 Check Character Calculation = Check C and K	

Code 11 Check Character Transmission

This feature enables/disables transmission of an optional Code 11 check character.

	 Code 11 Check Character Transmission = Don't Send
 Code 11 Check Character Transmission = Send	



Code 11 Minimum Reads

This feature specifies the minimum number of consecutive times a Code 11 label must be decoded before it is accepted as good read.

	 Code 11 Minimum Reads = 1
 Code 11 Minimum Reads = 2	
	 Code 11 Minimum Reads = 3
 Code 11 Minimum Reads = 4	

Code 11 Length Control

This feature specifies either variable length decoding or fixed length decoding for the Code 11 symbology.

Variable Length: For variable length decoding, a minimum and maximum length may be set.



Fixed Length: For fixed length decoding, two different lengths may be set.

	 Code 11 Length Control = Variable Length
 Code 11 Length Control = Fixed Length	

Code 11 Set Length 1

This feature specifies one of the bar code lengths for [Code 11 Length Control on page 169](#). Length 1 is the minimum label length if in [Variable Length on page 169 Mode](#), or the first fixed length if in [Fixed Length on page 169 Mode](#). Length includes the bar code's check and data characters.

The length can be set from 2 to 50 characters. See "[Set Length 1](#)" on page 245 for more detailed programming instructions.

 Select Code 11 Set Length 1 Setting	<p>To configure this feature, scan the ENTER/EXIT bar code above, then the bar code at left followed by digits from the Alphanumeric characters in Appendix D, Keypad representing your desired character(s). End by scanning the ENTER/EXIT bar code again.</p>
<p>Make a mistake? Scan the CANCEL bar code to abort and not save the entry string. You can then start again at the beginning.</p>	 CANCEL

 **04 = Length 1 is 4 Characters**



Code 11 Set Length 2

This feature specifies one of the bar code lengths for [Code 11 Length Control on page 169](#). Length 2 is the maximum label length if in [Variable Length on page 169 Mode](#), or the second fixed length if in [Fixed Length on page 169 Mode](#). Length includes the bar code's check and data characters.

The length can be set from 2 to 50 characters. A setting of 00 specifies to ignore this length (only one fixed length). See "[Set Length 2](#)" on page 247 for more detailed programming instructions.



To configure this feature, scan the ENTER/EXIT bar code above, then the bar code at left followed by digits from the Alphanumeric characters in [Appendix D, Keypad](#) representing your desired character(s). End by scanning the ENTER/EXIT bar code again.

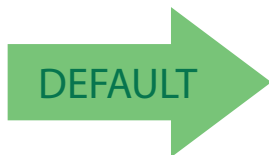

Make a mistake? Scan the CANCEL bar code to abort and not save the entry string. You can then start again at the beginning.



50 = Length 2 is 50 Characters

Code 11 Interdigit Ratio

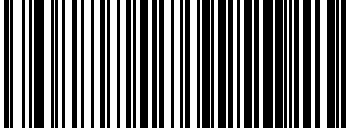
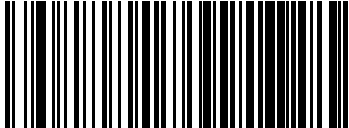
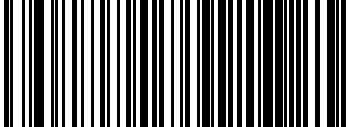
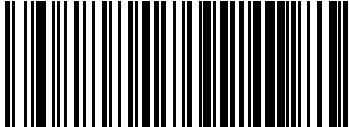
This feature specifies the ratio between an intercharacter space and module for Code 11 labels.

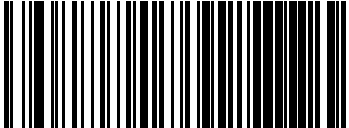
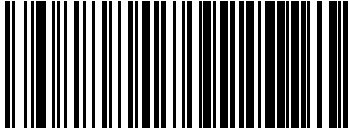
	 Code 11 Interdigit Ratio = Disable
 Code 11 Interdigit Ratio = 1	
	 Code 11 Interdigit Ratio = 2
 Code 11 Interdigit Ratio = 3	
	 Code 11 Interdigit Ratio = 4
 Code 11 Interdigit Ratio = 5	



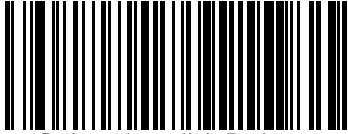
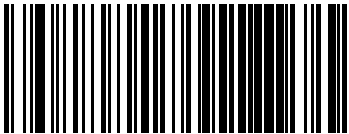
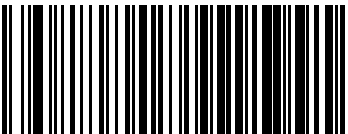
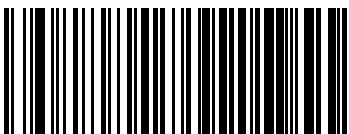
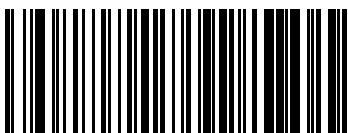

Code 11 Interdigit Ratio — cont.

	 <p>Code 11 Interdigit Ratio = 6</p>
 <p>Code 11 Interdigit Ratio = 7</p>	
	 <p>Code 11 Interdigit Ratio = 8</p>
 <p>Code 11 Interdigit Ratio = 9</p>	
	 <p>Code 11 Interdigit Ratio = 10</p>

Code 11 Decoding Level

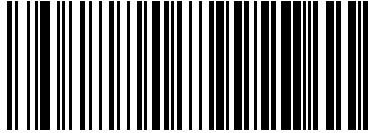
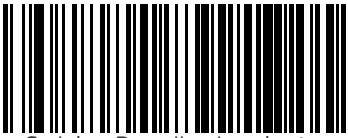
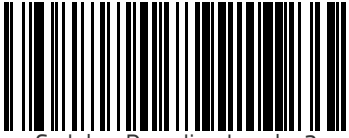
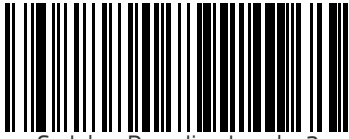
Decoding Levels are used to configure a bar code symbology decoder to be very aggressive to very conservative depending on a particular customer's needs. See "[Decoding Levels](#)" on page 245 for more detailed programming instructions.

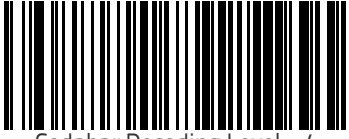
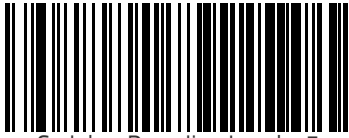
	 <p>Codabar Decoding Level = Disabled</p>
 <p>Codabar Decoding Level = 1</p>	
	 <p>Codabar Decoding Level = 2</p>
 <p>Codabar Decoding Level = 3</p>	
	 <p>Codabar Decoding Level = 4</p>
 <p>Codabar Decoding Level = 5</p>	



Standard 2 of 5

The following options apply to the Standard 2 of 5 symbology.

Standard 2 of 5 Enable/Disable

When disabled, the scanner will not read Standard 2 of 5 bar codes.

	 Standard 2 of 5 = Disable
 Standard 2 of 5 = Enable	

Standard 2 of 5 Check Character Calculation

This option enables/disables calculation and verification of an optional Standard 2 of 5 check character.

	 Standard 2 of 5 Check Character Calculation = Disable
 Standard 2 of 5 Check Character Calculation = Enable	

Standard 2 of 5 Check Character Transmission

This feature enables/disables transmission of an optional Standard 2 of 5 check character.

	 Standard 2 of 5 Check Character Transmission = Don't Send
 Standard 2 of 5 Check Character Transmission = Send	

Standard 2 of 5 Minimum Reads

This feature specifies the minimum number of consecutive times a Standard 2 of 5 label must be decoded before it is accepted as good read.

	 Standard 2 of 5 Minimum Reads = 1
 Standard 2 of 5 Minimum Reads = 2	
	 Standard 2 of 5 Minimum Reads = 3
 Standard 2 of 5 Minimum Reads = 4	



Standard 2 of 5 Decoding Level



NOTE

The Standard 2 of 5 Decoding Level feature is set using "I 2 of 5 Decoding Level" on page 141.

Standard 2 of 5 Length Control

This feature specifies either variable length decoding or fixed length decoding for the Standard 2 of 5 symbology.

Variable Length: For variable length decoding, a minimum and maximum length may be set.

Fixed Length: For fixed length decoding, two different lengths may be set.

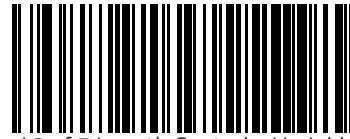
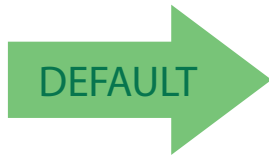

Standard 2 of 5 Length Control = Variable Length

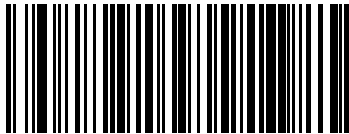



Standard 2 of 5 Length Control = Fixed Length

Standard 2 of 5 Set Length 1

This feature specifies one of the bar code lengths for [Standard 2 of 5 Length Control on page 176](#). Length 1 is the minimum label length if in [Variable Length on page 176](#) Mode, or the first fixed length if in [Fixed Length on page 176](#) Mode. Length includes the bar code's check and data characters.

The length can be set from 1 to 50 characters. See ["Set Length 1" on page 245](#) for more detailed programming instructions.

 Select Standard 2 of 5 Length 1 Setting	<p>To configure this feature, scan the ENTER/EXIT bar code above, then the bar code at left followed by digits from the Alphanumeric characters in Appendix D, Keypad representing your desired character(s). End by scanning the ENTER/EXIT bar code again.</p>
<p>Make a mistake? Scan the CANCEL bar code to abort and not save the entry string. You can then start again at the beginning.</p>	 CANCEL

08 = Length 1 is 8 Characters



Standard 2 of 5 Set Length 2

This feature specifies one of the bar code lengths for [Standard 2 of 5 Length Control on page 176](#). Length 2 is the maximum label length if in [Variable Length on page 176 Mode](#), or the second fixed length if in [Fixed Length on page 176 Mode](#). Length includes the bar code's check and data characters. The length can be set from 1 to 50 characters. A setting of 00 specifies to ignore this length (only one fixed length). See "[Set Length 2](#)" on page 247 for more detailed programming instructions.

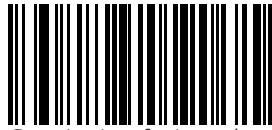

Select Standard 2 of 5 Length 2 Setting

To configure this feature, scan the ENTER/EXIT bar code above, then the bar code at left followed by digits from the Alphanumeric characters in [Appendix D, Keypad](#) representing your desired character(s). End by scanning the ENTER/EXIT bar code again.

Make a mistake? Scan the CANCEL bar code to abort and not save the entry string. You can then start again at the beginning.

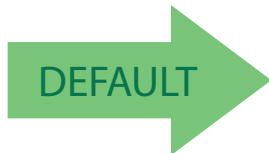

50 = Length 2 is 50 Characters

Industrial 2 of 5

The following options apply to the Industrial 2 of 5 symbology.

Industrial 2 of 5 Enable/Disable

Enables/Disables ability of scanner to decode Industrial 2 of 5 labels.

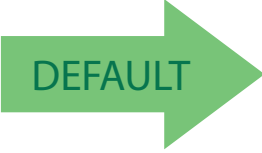
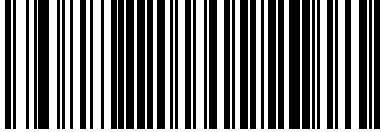
	 Industrial 2 of 5 = Disable
 Industrial 2 of 5 = Enable	

Industrial 2 of 5 Check Character Calculation

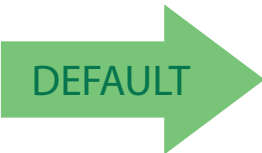
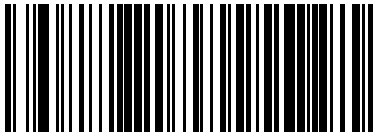
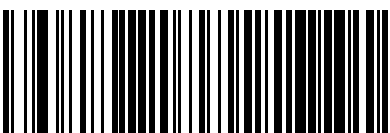

Enables/Disables calculation and verification of an optional Industrial 2 of 5 check character.

	 Industrial 2 of 5 Check Character Calculation = Disable
 Industrial 2 of 5 Check Character Calculation = Enable	

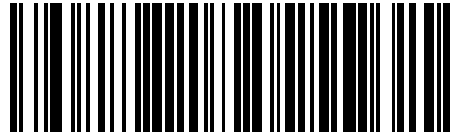
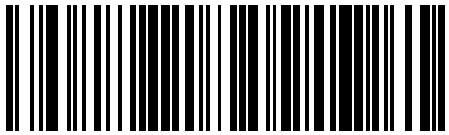

Industrial 2 of 5 Check Character Transmission

Enables/disables transmission of an Industrial 2 of 5 check character.

	 Industrial 2 of 5 Check Character Transmission = Disable
 Industrial 2 of 5 Check Character Transmission = Enable	

Industrial 2 of 5 Length Control

This feature specifies either variable length decoding or fixed length decoding for the Industrial 2 of 5 symbology.

Variable Length: For variable length decoding, a minimum and maximum length may be set.

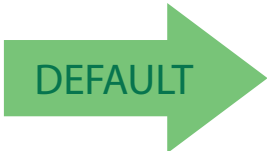
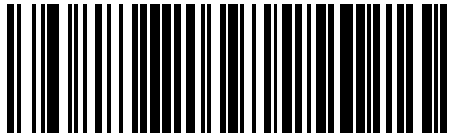
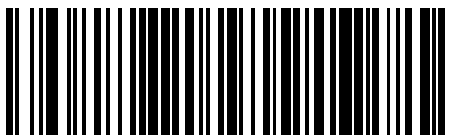

Fixed Length: For fixed length decoding, two different lengths may be set.

	 Industrial 2 of 5 Length Control = Variable Length
 Industrial 2 of 5 = Fixed Length	

Industrial 2 of 5 Set Length 1

This feature specifies one of the bar code lengths for **Industrial 2 of 5 Length Control** on page 180. Length 1 is the minimum label length if in **Variable Length** on page 120 Mode, or the first fixed length if in **Fixed Length** on page 120 Mode. Length includes the bar code's data characters only.

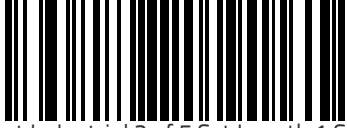
The length can be set from 1 to 50 characters. See "**Set Length 1**" on page 245 for more detailed programming instructions.

 Select Industrial 2 of 5 Set Length 1 Setting	<p>To configure this feature, scan the ENTER/EXIT bar code above, then the bar code at left followed by digits from the Alphanumeric characters in Appendix D, Keypad representing your desired character(s). End by scanning the ENTER/EXIT bar code again.</p>
<p>Make a mistake? Scan the CANCEL bar code to abort and not save the entry string. You can then start again at the beginning.</p>	 CANCEL

01 = Length 1 is 1 Character



Industrial 2 of 5 Set Length 2

This feature specifies one of the bar code lengths for **Industrial 2 of 5 Length Control** on page 180. Length 2 is the maximum label length if in **Variable Length** on page 120 Mode, or the second fixed length if in **Fixed Length** on page 120 Mode. Length includes the bar code’s check, data, and full-ASCII shift characters. The length does not include start/stop characters.

The length can be set from 1 to 50 characters. A setting of 00 specifies to ignore this length (only one fixed length). See **"Set Length 2"** on page 247 for more detailed programming instructions.



Select Industrial 2 of 5 Length 2 Setting

To configure this feature, scan the ENTER/EXIT bar code above, then the bar code at left followed by digits from the Alphanumeric characters in **Appendix D, Key-pad** representing your desired character(s). End by scanning the ENTER/EXIT bar code again.

Make a mistake? Scan the CANCEL bar code to abort and not save the entry string. You can then start again at the beginning.

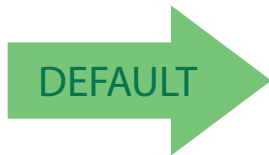

50 = Length 2 is 50 Characters

Industrial 2 of 5 Minimum Reads

This feature specifies the minimum number of consecutive times an Industrial 2 of 5 label must be decoded before it is accepted as good read.

	 Industrial 2 of 5 Minimum Reads = 1
 Industrial 2 of 5 Minimum Reads = 2	
	 Industrial 2 of 5 Minimum Reads = 3
 Industrial 2 of 5 Minimum Reads = 4	



IATA

The following options apply to the IATA symbology.

IATA Enable/Disable

Enables/Disables the ability of the scanner to decode IATA labels.

IATA Check Character Transmission

Enables/Disables calculation and verification of an optional Industrial 2 of 5 check character.

ISBT 128

The following options apply to the ISBT 128 symbology.

ISBT 128 Concatenation

Enables/disables ISBT128 concatenation of 2 labels.

	 ISBN 128 Concatenation = Disable
 ISBN 128 Concatenation = Enable	

ISBT 128 Concatenation Mode

Specifies the concatenation mode between Static and Dynamic.



NOTE



This option is only valid when ISBT 128 Concatenation on page 185 is enabled (see page 10-185).

	 ISBT 128 Concatenation Mode = Static
 ISBT 128 Concatenation Mode = Dynamic	

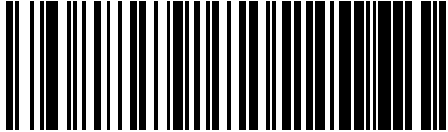
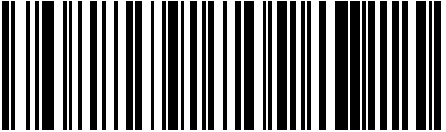

ISBT 128 Dynamic Concatenation Timeout

Specifies the timeout used by the ISBT 128 Dynamic Concatenation Mode.

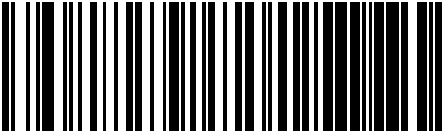
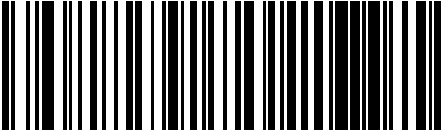
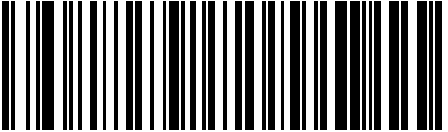
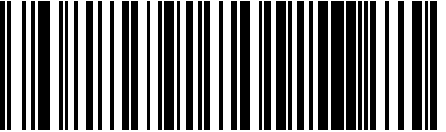
	 <p>ISBT 128 Dynamic Concatenation Timeout = 50 msec</p>
 <p>ISBT 128 Dynamic Concatenation Timeout = 100 msec</p>	
	 <p>ISBT 128 Dynamic Concatenation Timeout = 200 msec</p>
 <p>ISBT 128 Dynamic Concatenation Timeout = 500 msec</p>	
	 <p>ISBT 128 Dynamic Concatenation Timeout = 750 msec</p>
 <p>ISBT 128 Dynamic Concatenation Timeout = 1 second</p>	

ISBT 128 Force Concatenation

When enabled, this feature forces all ISBT 128 labels to be concatenated.



NOTE

This option is only valid when ISBT 128 Concatenation on page 185 is enabled. (see page 10-185).

	 <p>ISBT 128 Force Concatenation = Disable</p>
 <p>ISBT 128 Force Concatenation = Enable</p>	

ISBT 128 Advanced Concatenation Options



NOTE

Use the Datalogic Aladdin configuration application or Contact Customer Support to set up pairs of label types for concatenation.



MSI

The following options apply to the MSI symbology.

MSI Enable/Disable

Enables/Disables ability of scanner to decode MSI labels.

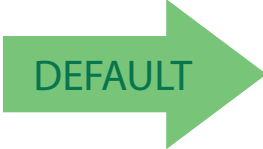
MSI Check Character Calculation

Enables/Disables calculation and verification of an optional MSI check character.

MSI Check Character Transmission

Enables/disables transmission of an MSI check character.

	 MSI Check Character Transmission = Disable
 MSI Check Character Transmission = Enable	

MSI Length Control

This feature specifies either variable length decoding or fixed length decoding for the MSI symbology.

Variable Length: For variable length decoding, a minimum and maximum length may be set.

Fixed Length: For fixed length decoding, two different lengths may be set.

	 MSI Length Control = Variable Length
 MSI = Fixed Length	



MSI Set Length 1

This feature specifies one of the bar code lengths for [MSI Length Control on page 189](#). Length 1 is the minimum label length if in [Variable Length on page 189 Mode](#), or the first fixed length if in [Fixed Length on page 189 Mode](#). Length includes the bar code's data characters only.

The length can be set from 01 to 50 characters. See "[Set Length 1](#)" on page 245 for more detailed programming instructions.



Select MSI Set Length 1 Setting

To configure this feature, scan the ENTER/EXIT bar code above, then the bar code at left followed by digits from the Alphanumeric characters in [Appendix D, Keypad](#) representing your desired character(s). End by scanning the ENTER/EXIT bar code again.

Make a mistake? Scan the CANCEL bar code to abort and not save the entry string. You can then start again at the beginning.

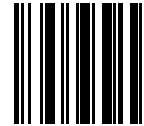

CANCEL

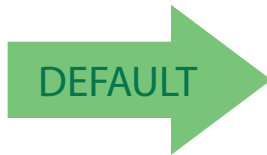

01 = Length 1 is 1 Character

MSI Set Length 2

This feature specifies one of the bar code lengths for [MSI Length Control on page 189](#). Length 2 is the maximum label length if in [Variable Length on page 189 Mode](#), or the second fixed length if in [Fixed Length on page 189 Mode](#). Length includes the bar code's check, data, and full-ASCII shift characters. The length does not include start/stop characters.

The length can be set from 1 to 50 characters. A setting of 0 specifies to ignore this length (only one fixed length). See ["Set Length 2" on page 247](#) for more detailed programming instructions.



Select MSI Length 2 Setting

To configure this feature, scan the ENTER/EXIT bar code above, then the bar code at left followed by digits from the Alphanumeric characters in [Appendix D, Key-pad](#) representing your desired character(s). End by scanning the ENTER/EXIT bar code again.

Make a mistake? Scan the CANCEL bar code to abort and not save the entry string. You can then start again at the beginning.

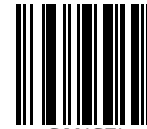

CANCEL

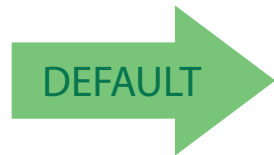

50 = Length 2 is 50 Characters



MSI Minimum Reads

This feature specifies the minimum number of consecutive times an MSI label must be decoded before it is accepted as good read.

	 MSI Minimum Reads = 1
 MSI Minimum Reads = 2	
	 MSI Minimum Reads = 3
 MSI Minimum Reads = 4	

MSI Decoding Level

Decoding Levels are used to configure a bar code symbology decoder to be very aggressive to very conservative depending on a particular customer's needs. See "[Decoding Levels](#)" on page 245 for more detailed programming instructions.

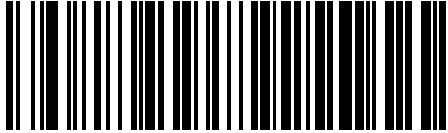
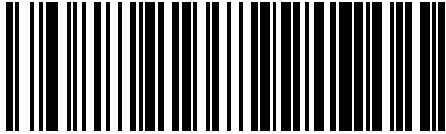
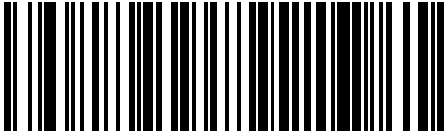
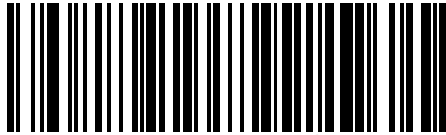
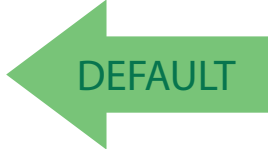
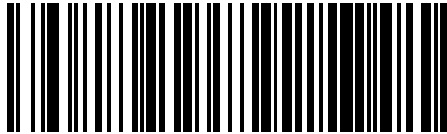
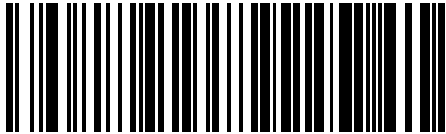
	 MSI Decoding Level = Disable
 MSI Decoding Level = 1	
	 MSI Decoding Level = 2
 MSI Decoding Level = 3	
	 MSI Decoding Level = 4
 MSI Decoding Level = 5	





Code 93

The following options apply to the Code 93 symbology.

Code 93 Enable/Disable

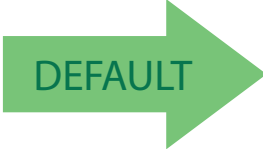
Enables/Disables ability of scanner to decode Code 93 labels.

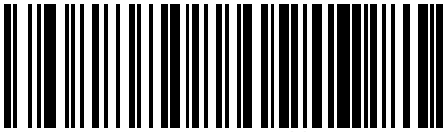
	 Code 93 = Disable
 Code 93 = Enable	

Code 93 Check Character Calculation

Enables/disables calculation and verification of an optional Code 93 check character.

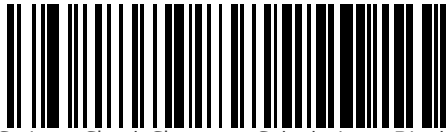
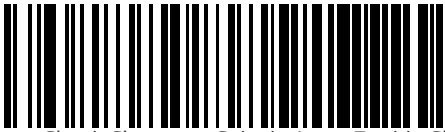
	 Code 93 Check Character Calculation = Disable
 Code 93 Check Character Calculation = Enable Check C	

	 Code 93 Check Character Calculation = Enable Check K
 Code 93 Check Character Calculation = Enable Check C and K	

Code 93 Check Character Transmission

Enables/disables transmission of an optional Code 93 check character.

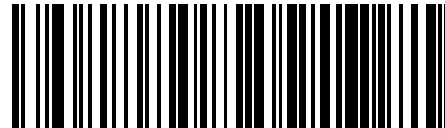
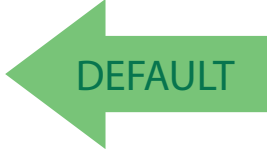
	 Code 93 Check Character Transmission = Disable
 Code 93 Check Character Transmission = Enable	

Code 93 Length Control

This feature specifies either variable length decoding or fixed length decoding for the Code 93 symbology.

Variable Length: For variable length decoding, a minimum and maximum length may be set.



Fixed Length: For fixed length decoding, two different lengths may be set.

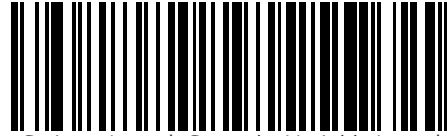
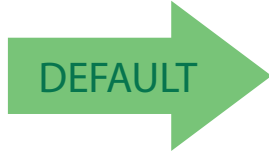

Code 93 Length Control = Variable Length

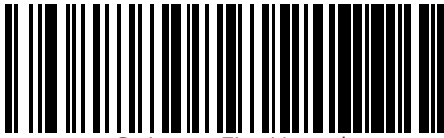



Code 93 = Fixed Length

Code 93 Set Length 1

This feature specifies one of the bar code lengths for **Code 93 Length Control** on page 195. Length 1 is the minimum label length if in **Variable Length** on page 195 Mode, or the first fixed length if in **Fixed Length** on page 196 Mode. Length includes the bar code's data characters only.

The length can be set from 01 to 50 characters. See "**Set Length 1**" on page 245 for more detailed programming instructions.

 Select Code 93 Set Length 1 Setting	<p>To configure this feature, scan the ENTER/EXIT bar code above, then the bar code at left followed by digits from the Alphanumeric characters in Appendix D, Keypad representing your desired character(s). End by scanning the ENTER/EXIT bar code again.</p>
<p>Make a mistake? Scan the CANCEL bar code to abort and not save the entry string. You can then start again at the beginning.</p>	 CANCEL

01 = Length 1 is 1 Character



Code 93 Set Length 2

This feature specifies one of the bar code lengths for **Code 93 Length Control** on page 195. Length 2 is the maximum label length if in **Variable Length** on page 195 Mode, or the second fixed length if in **Fixed Length** on page 196 Mode. Length includes the bar code’s check, data, and full-ASCII shift characters. The length does not include start/stop characters.

The length can be set from 1 to 50 characters. A setting of 00 specifies to ignore this length (only one fixed length). See **"Set Length 2"** on page 247 for more detailed programming instructions.



Select Code 93 Length 2 Setting

To configure this feature, scan the ENTER/EXIT bar code above, then the bar code at left followed by digits from the Alphanumeric characters in **Appendix D, Key-pad** representing your desired character(s). End by scanning the ENTER/EXIT bar code again.

Make a mistake? Scan the CANCEL bar code to abort and not save the entry string. You can then start again at the beginning.



CANCEL

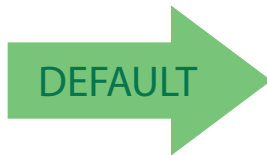

50 = Length 2 is 50 Characters

Code 93 Minimum Reads





This feature specifies the minimum number of consecutive times a Code 93 label must be decoded before it is accepted as good read.

	 Code 93 Minimum Reads = 1
 Code 93 Minimum Reads = 2	
	 Code 93 Minimum Reads = 3
 Code 93 Minimum Reads = 4	

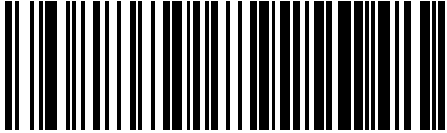
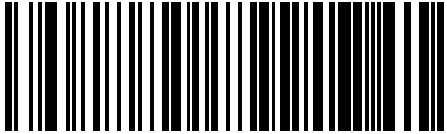

Code 93 Decoding Level

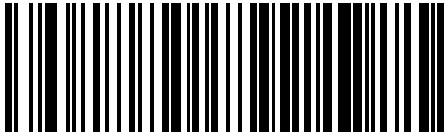
Decoding Levels are used to configure a bar code symbology decoder to be very aggressive to very conservative depending on a particular customer's needs. See "Decoding Levels" on page 245 for more detailed programming instructions.

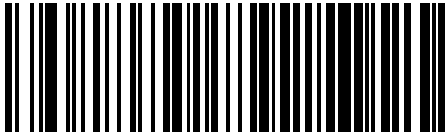
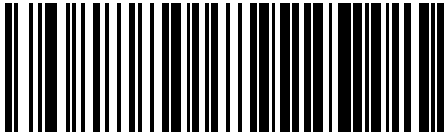
	 Code 93 Decoding Level = Disable
 Code 93 Decoding Level = 1	
	 Code 93 Decoding Level = 2
 Code 93 Decoding Level = 3	
	 Code 93 Decoding Level = 4
 Code 93 Decoding Level = 5	

Code 93 Quiet Zones

Enables/disables fixed length stitching for Code 93.



This feature is available only on the TD1130 model.

NOTE

	 <p>Code 93 Quiet Zones = No Quiet Zones</p>
 <p>Code 93 Quiet Zones = Quiet Zone on one side</p>	
	 <p>Code 93 Quiet Zones = Quiet Zones on two sides</p>
 <p>Code 93 Quiet Zones = Auto</p>	
	 <p>Code 93 Quiet Zones = Virtual Quiet Zones on two sides</p>



Codablock F

The following options apply to the Codablock F symbology.

Codablock F Enable/Disable

Enables/Disables the ability of the scanner to decode Codablock F labels.

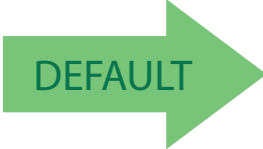
	 <p>Codablock F = Disable</p>
 <p>Codablock F = Enable</p>	

Codablock F EAN Enable/Disable

Enables/Disables the Codablock F EAN subtype (code with FNC1 in the first position).

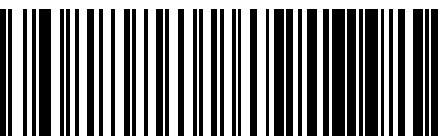
	 <p>Codablock F EAN = Disable</p>
 <p>Codablock F EAN = Enable</p>	

Codablock F AIM Check

Specifies if Check Digit calculation algorithm is AIM compliant or not.

	 Codablock F AIM Check = Not AIM compliant
 Codablock F AIM Check = AIM compliant	

Codablock F Length Control

This feature specifies either variable length decoding or fixed length decoding for the Codablock F symbology.

Variable Length: For variable length decoding, a minimum and maximum length may be set.

Fixed Length: For fixed length decoding, two different lengths may be set.

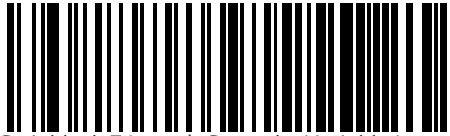
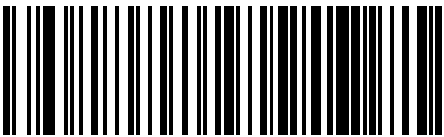
	 Codablock F Length Control = Variable Length
 Codablock F = Fixed Length	



Codablock F Set Length 1

This feature specifies one of the bar code lengths for **Codablock F Length Control** on page 203. Length 1 is the minimum label length if in **Variable Length** on page 203 Mode, or the first fixed length if in **Fixed Length** on page 203 Mode. Length includes the bar code's data characters only.

The length can be set from 003 to 255 characters. See "**Set Length 1**" on page 245 for more detailed programming instructions.



Select Codablock F Length 1 Setting

To configure this feature, scan the ENTER/EXIT bar code above, then the bar code at left followed by digits from the Alphanumeric characters in **Appendix D, Keypad** representing your desired character(s). End by scanning the ENTER/EXIT bar code again.

Make a mistake? Scan the CANCEL bar code to abort and not save the entry string. You can then start again at the beginning.

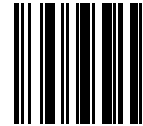

CANCEL

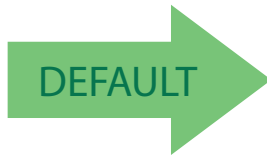

003 = Length 1 is 3 Characters

Codablock F Set Length 2

This feature specifies one of the bar code lengths for [Codablock F Length Control on page 203](#). Length 2 is the maximum label length if in [Variable Length on page 203 Mode](#), or the second fixed length if in [Fixed Length on page 203 Mode](#). Length includes the bar code's check, data, and full-ASCII shift characters. The length does not include start/stop characters.

The length can be set from 003 to 255 characters. A setting of 00 specifies to ignore this length (only one fixed length). See "[Set Length 2](#)" on page 247 for more detailed programming instructions.

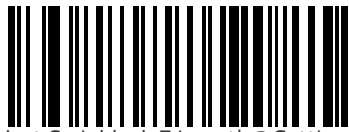

Select Codablock F Length 2 Setting

To configure this feature, scan the ENTER/EXIT bar code above, then the bar code at left followed by digits from the Alphanumeric characters in [Appendix D, Keypad](#) representing your desired character(s). End by scanning the ENTER/EXIT bar code again.

Make a mistake? Scan the CANCEL bar code to abort and not save the entry string. You can then start again at the beginning.



DEFAULT

100 = Length 2 is 100 Characters



Code 4

The following options apply to the Code 4 symbology.

Code 4 Enable/Disable

Enables/Disables ability of scanner to decode Code 4 labels.

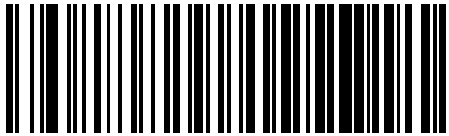
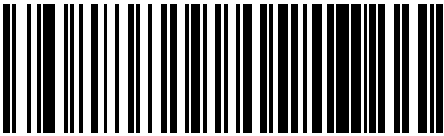
	 <p>Code 4 = Disable</p>
 <p>Code 4 = Enable</p>	

Code 4 Check Character Transmission

This feature enables/disables transmission of an optional Code 4 check character.

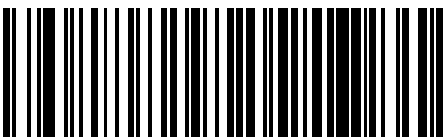
	 <p>Code 4 Check Character Transmission = Don't Send</p>
 <p>Code 4 Check Character Transmission = Send</p>	

Code 4 Hex to Decimal Conversion

This feature enables/disables the conversion of hexadecimal label data to decimal label data.

	 Code 4 Hex to Decimal Conversion = Disable
 Code 4 Hex to Decimal Conversion = Enable	

Code 5

The following options apply to the Code 5 symbology.

Code 5 Enable/Disable

Enables/Disables ability of scanner to decode Code 5 labels.

	 Code 5 = Disable
 Code 5 = Enable	



Code 5 Check Character Transmission

This feature enables/disables transmission of an optional Code 5 check character.

	 Code 5 Check Character Transmission = Don't Send
 Code 5 Check Character Transmission = Send	

Code 5 Hex to Decimal Conversion

This feature enables/disables the conversion of hexadecimal label data to decimal label data.

	 Code 5 Hex to Decimal Conversion = Disable
 Code 5 Hex to Decimal Conversion = Enable	

Code 4 and Code 5 Common Configuration Items

The following options apply to both Code 4 and Code 5 symbologies.

Code 4 and 5 Decoding Level

Decoding Levels are used to configure a bar code symbology decoder to be very aggressive to very conservative depending on a particular customer's needs. See "Decoding Levels" on page 245 for more programming instructions.



This configuration item applies to Code 4 and Code 5.

NOTE

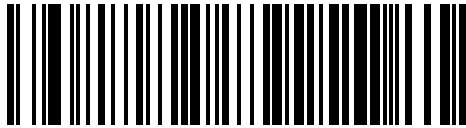
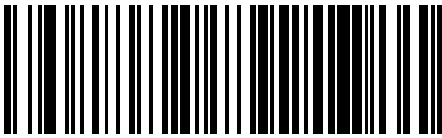
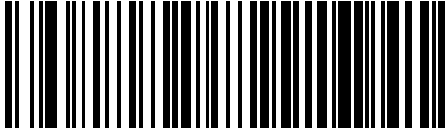
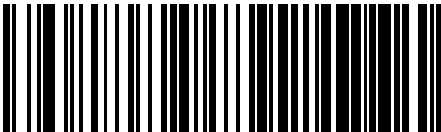
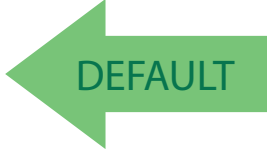
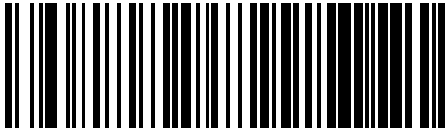
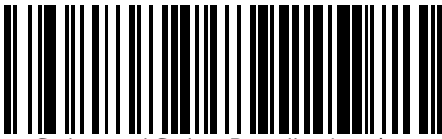
	 <p>Code 4 and Code 5 Decoding Level = Disabled</p>
 <p>Code 4 and Code 5 Decoding Level = 1</p>	
	 <p>Code 4 and Code 5 Decoding Level = 2</p>
 <p>Code 4 and Code 5 Decoding Level = 3</p>	
	 <p>Code 4 and Code 5 Decoding Level = 4</p>
 <p>Code 4 and Code 5 Decoding Level = 5</p>	



Code 4 and Code 5 Minimum Reads

This feature specifies the minimum number of consecutive times a Code 4 or Code 5 label must be decoded before it is accepted as good read.



	 <p>Code 4 or Code 5 Minimum Reads = 1</p>
 <p>Code 4 or Code 5 Minimum Reads = 2</p>	
	 <p>Code 4 or Code 5 Minimum Reads = 3</p>
 <p>Code 4 or Code 5 Minimum Reads = 4</p>	

Follett 2 of 5

The following options apply to the Follett 2 of 5 symbology.

Follett 2 of 5 Enable/Disable

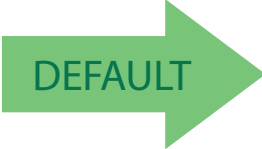
Enables/Disables ability of scanner to decode Follett 2 of 5 labels.

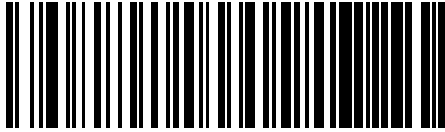
	 Follett 2 of 5 = Disable
 Follett 2 of 5 = Enable	

BC412

The following options apply to the BC412 symbology.

BC412 Enable/Disable

Enables/Disables ability of scanner to decode BC412 labels.

	 BC412 = Disable
 BC412 = Enable	



BC412 Check Character Calculation

Enable this option to enable/disable calculation and verification of an optional BC412 check character. When disabled, any check character in the label is treated as a data character.

	<p>BC412 Check Character Calculation = Don't Calculate</p>
<p>BC412 Check Character Calculation = Calculate Check Character</p>	



BC412 Minimum Reads

This feature specifies the minimum number of consecutive times a BC412 label must be decoded before it is accepted as good read.

	<p>BC412 Minimum Reads = 1</p>
<p>BC412 Minimum Reads = 2</p>	
<p>BC412 Minimum Reads = 3</p>	
<p>BC412 Minimum Reads = 4</p>	

BC412 Decoding Level

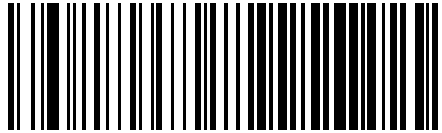
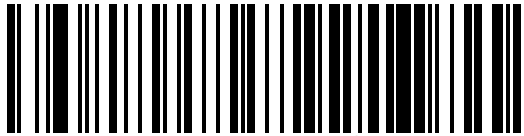
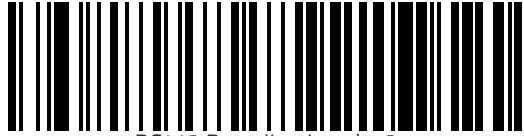
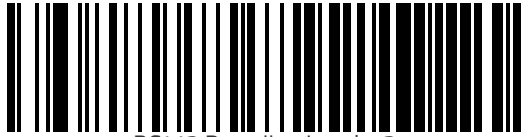
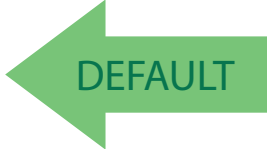
Decoding Levels are used to configure a bar code symbology decoder to be very aggressive to very conservative depending on a particular customer's needs. See "Decoding Levels" on page 245 for more detailed programming instructions.

	 BC412 Decoding Level = Disable
 BC412 Decoding Level = 1	
	 BC412 Decoding Level = 2
 BC412 Decoding Level = 3	
	 BC412 Decoding Level = 4
 BC412 Decoding Level = 5	



BC412 Length Control

This feature specifies either variable length decoding or fixed length decoding for the BC412 symbology.

Variable Length: For variable length decoding, a minimum and maximum length may be set.

Fixed Length: For fixed length decoding, two different lengths may be set.

	 BC412 Length Control = Variable Length
 BC412 Length Control = Fixed Length	

BC412 Set Length 1

This feature specifies one of the bar code lengths for [BC412 Length Control on page 214](#). Length 1 is the minimum label length if in [Variable Length on page 214 Mode](#), or the first fixed length if in [Fixed Length on page 214 Mode](#). Length includes the bar code's data characters only.

The length can be set from 01 to 50 characters. See "[Set Length 1](#)" on page 245 for more detailed programming instructions.

 Select BC412 Set Length 1 Setting	To configure this feature, scan the ENTER/EXIT bar code above, then the bar code at left followed by digits from the Alphanumeric characters in Appendix D, Keypad representing your desired character(s). End by scanning the ENTER/EXIT bar code again.
Make a mistake? Scan the CANCEL bar code to abort and not save the entry string. You can then start again at the beginning.	 CANCEL

01 = Length 1 is 1 Character

BC412 Set Length 2

This feature specifies one of the bar code lengths for **BC412 Length Control** on page 214. Length 2 is the maximum label length if in **Variable Length** on page 214 Mode, or the second fixed length if in **Fixed Length** on page 214 Mode. Length includes the bar code's check, data, and full-ASCII shift characters. The length does not include start/stop characters.

The length can be set from 1 to 50 characters. A setting of 00 specifies to ignore this length (only one fixed length). See "**Set Length 2**" on page 247 for more detailed programming instructions.

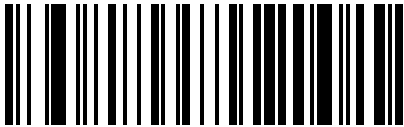
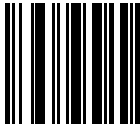
 Select BC412 Length 2 Setting	<p>To configure this feature, scan the ENTER/EXIT bar code above, then the bar code at left followed by digits from the Alphanumeric characters in Appendix D, Keypad representing your desired character(s). End by scanning the ENTER/EXIT bar code again.</p>
<p>Make a mistake? Scan the CANCEL bar code to abort and not save the entry string. You can then start again at the beginning.</p>	 CANCEL

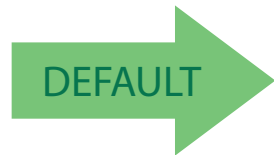

50 = Length 2 is 50 Characters



NOTES



Chapter 4 References

This section contains explanations and examples of selected bar code features. See "Configuration Using Bar Codes" starting on page 17 for the actual bar code labels used to configure the scanner.

RS-232 PARAMETERS on page 218 <ul style="list-style-type: none">▪ RS-232 Only on page 218▪ RS-232/USB COM Parameters on page 219
KEYBOARD INTERFACE on page 226 <ul style="list-style-type: none">▪ Wedge Quiet Interval on page 226▪ Intercharacter Delay on page 227▪ Intercode Delay on page 228
DATA FORMAT on page 229 <ul style="list-style-type: none">▪ Data Editing on page 229▪ Global Prefix/Suffix on page 230▪ Global AIM ID on page 231▪ Label ID on page 232▪ Character Conversion on page 236
READING PARAMETERS on page 237 <ul style="list-style-type: none">▪ Label Gone Timeout on page 237▪ RGB LED Features on page 238▪ Scanning Features on page 241
SCANNING FEATURES on page 241 <ul style="list-style-type: none">▪ Scan Mode on page 241▪ Scanning Active Time on page 242▪ Flash On Time on page 243▪ Flash Off Time on page 244
SYMBOLOGIES on page 245 <ul style="list-style-type: none">▪ Decoding Levels on page 245▪ Set Length on page 245

RS-232 Parameters

RS-232 Only

Baud Rate

Baud rate is the number of bits of data transmitted per second. Set the scanner's baud rate to match the baud rate setting of the host device. With an improper baud rate setting, data may not reach the host correctly.

Stop Bits

The stop bit(s) at the end of each transmitted character marks the end of transmission of one character and prepares the receiving device for the next character in the serial data stream. The number of stop bits selected (one or two) depends on the number the receiving terminal is programmed to accommodate. Set the number of stop bits to match host device requirements.

Parity

This feature specifies parity required for sending and receiving data. A parity check bit is the most significant bit of each ASCII coded character. Select the parity type according to host device requirements.

- Select None when no parity bit is required.
- Select Odd parity and the parity bit value is set to 0 or 1, based on data, to ensure that an odd number of 1 bits are contained in the coded character.
- Select Even parity and the parity bit value is set to 0 or 1, based on data, to ensure that an even number of 1 bits are contained in the coded character.

Handshaking Control

The data interface consists of an RS-232 port designed to operate either with or without the hardware handshaking lines, Request to Send (RTS), and Clear to Send (CTS). Handshaking Control includes the following options:

- RTS — RTS is asserted during transmissions. CTS is ignored.
- RTS/CTS — RTS is asserted during transmissions. CTS gates transmissions.
- RTS/XON/XOFF — RTS is asserted during transmissions. CTS is ignored. XON and XOFF gate transmissions.
- RTS On/CTS — RTS is always asserted. CTS gates transmissions.
- RTS/CTS Scan Control — RTS is asserted during transmissions. CTS gates transmissions and controls enable and disable state of scanner.

RS-232/USB COM Parameters

Intercharacter Delay

This parameter specifies the intercharacter delay between the end of one character and the beginning of the next. The delay can be set within a range of zero (0) to 990 milliseconds in 10ms increments. A setting of zero specifies no delay.

To set the delay:

1. Determine the desired setting in milliseconds.
2. Divide the desired setting by 10 (setting is in 10ms increments). Pad the result with leading zeroes to yield two digits. For example: 0 = 00, 5 = 05, 20 = 20, etc.
3. Scan the ENTER/EXIT PROGRAMMING MODE bar code to enter Programming Mode.
4. Go to [page 26](#) and scan the bar code: SELECT INTERCHARACTER DELAY SETTING.
5. Scan the appropriate two digits from the keypad in [Appendix D, Keypad](#), that represent the duration which was determined in the steps above. You will hear a two-beep indication after the last character.



NOTE

If you make a mistake before the last character, scan the CANCEL bar code to abort and not save the entry string. You can then start again at the beginning.

6. Scan the ENTER/EXIT PROGRAMMING MODE bar code to exit.

This completes the procedure. See the following table for examples of how to set this feature.

Table 2. Intercharacter Delay Setting Examples

STEP	ACTION	EXAMPLES			
1	Desired Setting	50ms	150ms	600ms	850ms
2	Divide by 10 (pad with leading zeroes to yield two-digits)	05	15	60	85
3	Scan ENTER/EXIT PROGRAMMING MODE				
4	Scan SELECT INTERCHARACTER DELAY SETTING				
5	Scan Two Characters From Appendix D, Keypad	'0' and '5'	'1' and '5'	'6' and '0'	'8' and '5'
6	Scan ENTER/EXIT PROGRAMMING MODE				

ACK NAK Options

This enables/disables the ability of the scanner to support the RS-232 ACK/NAK protocol. When configured, the scanner and/or host sends an “ACK” when it receives data properly, and sends “NAK” when the data is in error.

Options are:

- Disable
- Enable for label transmission — The scanner expects an ACK/NAK response from the host when a label is sent
- Enable for host-command acknowledge — The scanner will respond with ACK/NAK when the host sends a command
- Enable for label transmission and host-command acknowledge

ACK Character

This setting specifies an ASCII character or hex value to be used as the ACK character. ASCII characters or any hex value from 0 to 0xFF can be selected.



NOTE

Setting to previously defined characters such as XON, XOFF, or host commands conflicts with normal operation of these characters. 8-bit data is not recognized when the option Stop Bits on page 22 has been set as 7 Data Bits.

1. Determine the desired character or value.
 2. Use the [ASCII Chart on page 287](#) on the inside back cover of this manual to find the hex equivalent for the desired character/value.
 3. Go to [page 29](#) and scan ENTER/EXIT PROGRAMMING MODE to enter Programming Mode.
 4. Scan the bar code: SELECT ACK CHARACTER SETTING.
 5. Scan the appropriate two alphanumeric characters from the keypad in [Appendix D, Keypad](#), that represent the desired character/value determined above. The second character will cause a two-beep indication.
 6. Scan the ENTER/EXIT PROGRAMMING MODE bar code to exit.
- See the table below for examples of how to set this feature.

Table 3. ACK Character Setting Examples

STEP	ACTION	EXAMPLES			
1	Desired Character/Value	ACK	\$	@	>
2	Hex equivalent from ASCII Chart on page 287	0x06	0x24	0x40	0x3E
3	Scan ENTER/EXIT PROGRAMMING MODE				
4	Scan SELECT ACK CHARACTER SETTING				
5	Scan Two Characters from Appendix D, Keypad	'0' and '6'	'2' and '4'	'4' and '0'	'3' AND 'E'
6	Scan ENTER/EXIT PROGRAMMING MODE				

NAK Character

This setting specifies an ASCII character or hex value to be used as the NAK character. ASCII characters or any hex value from 0 to 0xFF can be selected.



NOTE

Setting to previously defined characters such as XON, XOFF, or host commands conflicts with normal operation of these characters. 8-bit data is not recognized when the option Stop Bits on page 22 has been set as 7 Data Bits.

To set this feature:

1. Determine the desired character or value.
2. Use the [ASCII Chart on page 287](#) on the inside back cover of this manual to find the hex equivalent for the desired character/value.
3. Scan the ENTER/EXIT PROGRAMMING MODE bar code to enter Programming Mode.
4. Scan the bar code: SELECT NAK CHARACTER SETTING.
5. Scan the appropriate two alpha-numeric characters from the keypad in [Appendix D, Keypad](#), that represent the desired character/value determined above. The second character will cause a two-beep indication.
6. Scan the ENTER/EXIT PROGRAMMING MODE bar code to exit Programming Mode.

This completes the procedure. See the table below for examples of how to set this feature.

Table 4. NAK Character Setting Examples

STEP	ACTION	EXAMPLES			
1	Desired Character/Value	NAK	\$	@	>
2	Hex equivalent	0x15	0x24	0x40	0x3E
3	Scan ENTER/EXIT PROGRAMMING MODE				
4	Scan SELECT NAK CHARACTER SETTING				
5	Scan Two Characters From Appendix D, Keypad	'1' and '5'	'2' and '4'	'4' and '0'	'3' AND 'E'
6	Scan ENTER/EXIT PROGRAMMING MODE				

ACK NAK Timeout Value

This option specifies the amount of time the scanner waits for an ACK character from the host following label transmission. The selectable timeout range is 200 milliseconds to 15,000ms (15 seconds) in 200ms increments. A selection of 0 disables the timeout.

To set this value:

1. Determine the desired setting in milliseconds.
2. Divide the desired setting by 200 (setting is in 200ms increments). Pad the result with leading zeroes to yield two digits. For example: 0 = 00, 5 = 05, 20 = 20, etc.
3. Go to [page 30](#) and scan the ENTER/EXIT PROGRAMMING MODE bar code to enter Programming Mode.
4. Scan the bar code: SELECT ACK NAK TIMEOUT VALUE SETTING.
5. Scan the appropriate two digits from the keypad in [Appendix D, Keypad](#), that represent the duration which was determined in the steps above. You will hear a two-beep indication after the last character.



NOTE

If you make a mistake before the last character, scan the **CANCEL** bar code to abort and not save the entry string. You can then start again at the beginning.

6. Scan the ENTER/EXIT PROGRAMMING MODE bar code to exit Programming Mode.

This completes the procedure. See the table below for examples of how to set this feature.

Table 5. ACK NAK Timeout Value Setting Examples

STEP	ACTION	EXAMPLES			
1	Desired Setting	200ms	1,000ms (1 sec.)	5200ms (5.2 sec.)	15,000ms (15 sec.)
2	Divide by 200	01	05	26	75
3	Scan ENTER/EXIT PROGRAMMING MODE				
4	Scan SELECT ACK NAK TIMEOUT VALUE SETTING				
5	Scan Two Characters From Appendix D, Keypad	'0' and '1'	'0' and '5'	'2' and '6'	'7' and '5'
6	Scan ENTER/EXIT PROGRAMMING MODE				

ACK NAK Retry Count

This feature specifies the number of times the scanner retries a label transmission due to a retry condition. The selectable range is from 1 to 254 retries. A selection of 0 disables the count, and a selection of 255 specifies unlimited retries.

To set this feature:

1. Determine the desired setting.
2. Pad the number with leading zeroes to yield three digits. For example: 0 = 000, 5 = 005, 20 = 020, etc.
3. Go to [page 31](#) and scan the ENTER/EXIT PROGRAMMING MODE bar code to enter Programming Mode.
4. Scan the bar code: SELECT ACK NAK RETRY COUNT SETTING.
5. Scan the appropriate three digits from the keypad in [Appendix D, Keypad](#), that represent the number which was determined in the steps above. You will hear a two-beep indication after the last character.



NOTE

If you make a mistake before the last character, scan the CANCEL bar code to abort and not save the entry string. You can then start again at the beginning.

6. Scan the ENTER/EXIT PROGRAMMING MODE bar code to exit Programming Mode.

This completes the procedure. See the table below for examples of how to set this feature.

Table 6. ACK NAK Retry Count Setting Examples

STEP	ACTION	EXAMPLES			
1	Desired Setting	Disable Retry Count	3 Retries	54 Retries	Unlimited Retries
2	Pad with leading zero(es)	000	003	054	255
3	Scan ENTER/EXIT PROGRAMMING MODE				
4	Scan SELECT ACK NAK RETRY COUNT SETTING				
5	Scan Three Characters From Appendix D, Keypad	'0', '0' and '0'	'0', '0' and '3'	'0', '5' and '4'	'2', '5' and '5'
6	Scan ENTER/EXIT PROGRAMMING MODE				

Disable Character

Specifies the value of the RS-232 host command used to disable the scanner. ASCII characters or any hex value from 0 to 0xFF can be selected.



NOTE

Setting to previously defined characters such as XON, XOFF, or host commands conflicts with normal operation of these characters. 8-bit data is not recognized when the option Stop Bits on page 22 has been set as 7 Data Bits.

To set the value:

1. Determine the desired character or value. A setting of 0xFF indicates the Disable Character is not used (not available).
2. Use the [ASCII Chart on page 287](#) on the inside back cover of this manual to find the hex equivalent for the desired character/value.
3. Go to [page 33](#) and scan the ENTER/EXIT PROGRAMMING MODE bar code to enter Programming Mode.
4. Scan the bar code: SELECT DISABLE CHARACTER SETTING on [page 33](#).
5. Scan the appropriate two alphanumeric characters from the keypad in [Appendix D, Keypad](#), that represent the desired character/value determined above. The second character will cause a two-beep indication.
6. Scan the ENTER/EXIT PROGRAMMING MODE bar code to exit Programming Mode.

This completes the procedure. See the table below for examples of how to set this feature.

Table 7. Disable Character Setting Examples

STEP	ACTION	EXAMPLES			
1	Desired character/value	'd'	'}'	'D'	Disable Command Not Used
2	Hex equivalent from ASCII Chart on page 287	0x64	0x7D	0x44	0xFF
3	Scan ENTER/EXIT PROGRAMMING MODE				
4	Scan SELECT DISABLE CHARACTER VALUE SETTING				
5	Scan Two Characters From Appendix D, Keypad	'6' and '4'	'7' and 'D'	'4' and '4'	'F' and 'F'
6	Scan ENTER/EXIT PROGRAMMING MODE				

Enable Character

Specifies the value of the RS-232 host command used to enable the scanner. ASCII characters or any hex value from 0 to 0xFF can be selected.



NOTE

Setting to previously defined characters such as XON, XOFF, or host commands conflicts with normal operation of these characters. 8-bit data is not recognized when the option Stop Bits on page 22 has been set as 7 Data Bits.

To set this feature:

Determine the desired character or value. A setting of 0xFF indicates the Enable Character is not used (not available).

1. Determine the desired character or value.
2. Use the [ASCII Chart on page 287](#) on the inside back cover of this manual to find the hex equivalent for the desired character/value.
3. Go to [page 34](#) and scan the ENTER/EXIT PROGRAMMING MODE bar code to enter Programming Mode.
4. Scan the bar code: SELECT ENABLE CHARACTER SETTING on [page 34](#).
5. Scan the appropriate two alphanumeric characters from the keypad in [Appendix D, Keypad](#), that represent the desired character/value determined above. The second character will cause a two-beep indication.
6. Scan the ENTER/EXIT PROGRAMMING MODE bar code to exit Programming Mode.

This completes the procedure. See the table below for examples of how to set this feature.

Table 8. Enable Character Setting Examples

STEP	ACTION	EXAMPLES			
1	Desired character/value	'e'	'}'	'E'	Enable Command Not Used
2	Hex equivalent from ASCII Chart on page 287	0x65	0x7D	0x45	0xFF
3	Scan ENTER/EXIT PROGRAMMING MODE				
4	Scan SELECT ENABLE CHARACTER SETTING				
5	Scan Two Characters From Appendix D, Keypad	'6' and '5'	'7' and 'D'	'4' and '5'	'F' and 'F'
6	Scan ENTER/EXIT PROGRAMMING MODE				

Keyboard Interface

Wedge Quiet Interval

Specifies the amount of time the scanner looks for keyboard activity before it breaks the keyboard connection in order to transmit data to host. The range is from 0 to 990ms in 10ms increments.



This feature applies **ONLY** to the Keyboard Wedge interface.

NOTE

1. Determine the desired setting in milliseconds.
2. Divide the desired setting by 10 (setting is in 10ms increments). Pad the result with leading zeroes to yield two digits. For example: 0 = 00, 5 = 05, 20 = 20, etc.
3. Go to [page 42](#) and scan the ENTER/EXIT PROGRAMMING MODE bar code to enter Prog. Mode.
4. Scan the bar code: SELECT WEDGE QUIET INTERVAL SETTING on [page 42](#).
5. Scan the appropriate two digits from the keypad in [Appendix D, Keypad](#), that represent the duration which was determined in the steps above. You will hear a two-beep indication after the last character.



If you make a mistake before the last character, scan the CANCEL bar code to abort and not save the entry string. You can then start again at the beginning.

NOTE

6. Scan the ENTER/EXIT PROGRAMMING MODE bar code to exit.
- This completes the procedure to set the Wedge Quiet Interval. See the table below for examples of how to set this feature.

Table 9. Wedge Quiet Interval Setting Examples

STEP	ACTION	EXAMPLES			
1	Desired Setting	10ms	150ms	600ms	850ms
2	Divide by 10 (and pad with leading zeroes)	01	15	60	85
3	Scan ENTER/EXIT PROGRAMMING MODE				
4	Scan SELECT WEDGE QUIET INTERVAL SETTING				
5	Scan Two Characters From Appendix D, Keypad	'0' and '1'	'1' and '5'	'6' and '0'	'8' and '5'
6	Scan ENTER/EXIT PROGRAMMING MODE				

Intercharacter Delay

This parameter specifies the intercharacter delay between the end of one character and the beginning of the next. The delay can be set within a range of zero (0) to 990 milliseconds in 10ms increments. A setting of zero specifies no delay.



This feature applies **ONLY** to the Keyboard Wedge interface.

NOTE

To set the delay:

1. Determine the desired setting in milliseconds.
2. Divide the desired setting by 10 (setting is in 10ms increments). Pad the result with leading zeroes to yield two digits. For example: 0 = 00, 5 = 05, 20 = 20, etc.
3. Go to [page 43](#) and scan the ENTER/EXIT PROGRAMMING MODE bar code to enter Programming Mode.
4. Scan the bar code: SELECT INTERCHARACTER DELAY SETTING on [page 43](#).
5. Scan the appropriate two digits from the keypad in [Appendix D, Keypad](#), that represent the duration which was determined in the steps above. You will hear a two-beep indication after the last character.



If you make a mistake before the last character, scan the **CANCEL** bar code to abort and not save the entry string. You can then start again at the beginning.

NOTE

6. Scan the ENTER/EXIT PROGRAMMING MODE bar code to exit Programming Mode.

This completes the procedure. See the table below for examples of how to set this feature.

Table 10. Intercharacter Delay Setting Examples

STEP	ACTION	EXAMPLES			
1	Desired Setting	50ms	150ms	600ms	850ms
2	Divide by 10 (and pad with leading zeroes to yield two-digits)	05	15	60	85
3	Scan ENTER/EXIT PROGRAMMING MODE				
4	Scan SELECT INTERCHARACTER DELAY SETTING				
5	Scan Two Characters From Appendix D, Keypad	'0' and '5'	'1' and '5'	'6' and '0'	'8' and '5'
6	Scan ENTER/EXIT PROGRAMMING MODE				

Intercode Delay

Specifies the delay between labels transmitted to the host for this interface. The selectable range for this feature is from 0 to 99 seconds.

Follow these instructions to set this feature:

1. Determine the desired setting.
2. Pad the number with leading zeroes to yield two digits. For example: 0 = 00, 5 = 05, 20 = 20, etc
3. Go to [page 44](#) and scan the ENTER/EXIT PROGRAMMING MODE bar code to enter Programming Mode.
4. Scan the bar code: SELECT INTERCODE DELAY SETTING on [page 44](#).
5. Scan the appropriate two digits from the keypad in [Appendix D, Keypad](#), that represent the duration which was determined in the steps above. You will hear a two-beep indication after the last character.



NOTE

If you make a mistake before the last character, scan the CANCEL bar code to abort and not save the entry string. You can then start again at the beginning.

6. Scan the ENTER/EXIT PROGRAMMING MODE bar code to exit Programming Mode.

This completes the procedure. See the table below for examples of how to set this feature.

Table 11. Wedge Intercode Delay Examples

STEP	ACTION	EXAMPLES			
1	Desired Setting	No Delay	5 Seconds	60 Seconds	99 Seconds
2	Pad with leading zero(es)	00	05	60	99
3	Scan ENTER/EXIT PROGRAMMING MODE				
4	Scan SELECT INTERCODE DELAY SETTING				
5	Scan Two Characters From Appendix D, Keypad	'0' and '0'	'0' and '5'	'6' and '0'	'9' and '9'
6	Scan ENTER/EXIT PROGRAMMING MODE				

Data Format

Data Editing

When a bar code is scanned, additional information can be sent to the host computer along with the bar code data. This combination of bar code data and supplementary user-defined data is called a “message string.” The Data Editing features can be used to build specific user-defined data into a message string. There are several types of selectable data characters that can be sent before and after scanned data. You can specify if they should be sent with all symbologies, or only with specific symbologies. The following shows the available elements you can add to a message string:

Figure 4. Breakdown of a Message String

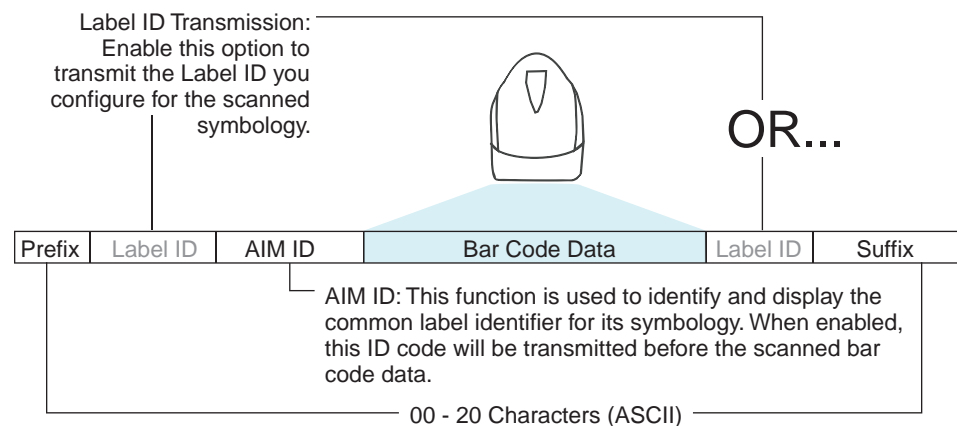

Additional advanced editing is available. See the [Advanced formatting features in the Datalogic Aladdin configuration software](#), or contact [Technical Support \(see page 3\)](#) for more information.

Please Keep In Mind...

- Modifying a message string is not a mandatory requirement. Data editing is a sophisticated feature allowing highly customizable output for advanced users. Factory default settings for data editing is typically set to NONE.
- A prefix or suffix may be applied only to a specified symbology (reference [Symbologies, starting on page 85](#)) or across all symbologies (set via the Global features in [Configuration Using Bar Codes, starting on page 17](#)).
- You can add any character from the [ASCII Chart on page 287](#) (from 00–FF) on the inside back cover of this manual as a prefix, suffix or Label ID.
- Enter prefixes and suffixes in the order in which you want them to appear on the output.

Global Prefix/Suffix

Up to 20 ASCII characters may be added as a prefix (in a position before the bar code data) and/or as a suffix (in a position following the bar code data) as indicated.

Figure 5. Prefix and Suffix Positions

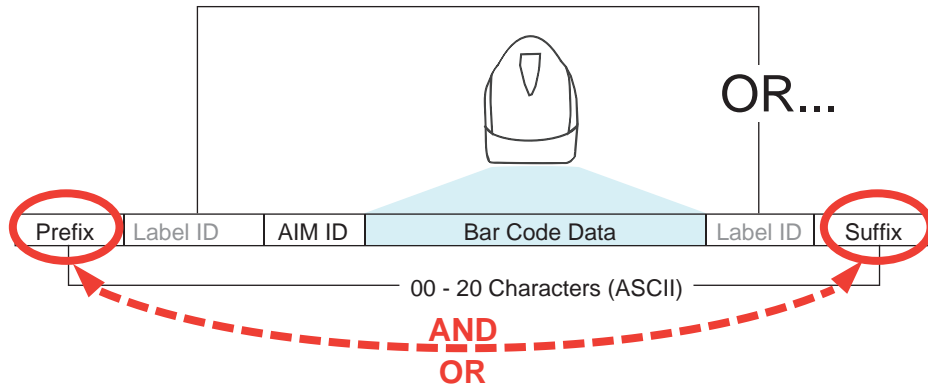

Example: Setting a Prefix

In this example, we'll set a prefix for all symbologies.

1. Determine which ASCII character(s) are to be added to scanned bar code data. In this example, we'll add a dollar sign ('\$') as a prefix.
2. Go to [page 50](#) and scan the ENTER/EXIT PROGRAMMING MODE bar code, then scan the SET GLOBAL PREFIX bar code.
3. Reference the [ASCII Chart on page 287](#) on the inside back cover of this manual to find the hex value assigned to the desired character. The corresponding hex number for the '\$' character is 24. To enter this selection code, scan the '2' and '4' bar codes from [Appendix D, Keypad](#).



NOTE

If you make a mistake before the last character, scan the CANCEL bar code to abort and not save the entry string. You can then start again at the beginning.

4. If less than the expected string of 20 characters are selected, scan the ENTER/EXIT bar code to terminate the string.
5. Scan the ENTER/EXIT bar code once again to exit Programming Mode.
6. The resulting message string would appear as follows:
Scanned bar code data: 12345
Resulting message string output: \$12345

Global AIM ID



This feature enables/disables addition of AIM IDs for all symbology types.

NOTE

AIM label identifiers (as opposed to custom characters you select yourself as with label identifiers) can be included with scanned bar code data. AIM label identifiers consist of three characters as follows:

- A close brace character (ASCII ‘}’), followed by...
- A code character (see the table below), followed by...
- A modifier character (the modifier character is symbol dependent).

SYMBOLGY	CHAR	SYMBOLGY	CHAR
UPC/EAN	E ^a	Code 128/GS1-128	C
Code 39 and Code 32	A	DataBar Omnidirectional, DataBar Expanded	e
Codabar	F	Standard 2 of 5	S
Interleaved 2 of 5	I	ISBN	X ^b
Code 93	G	Code 11	H

- UPC-A and UPC-E labels are converted to EAN 13 when adding AIM IDs.
- ISBN (X with a 0 modifier character)

Figure 6. AIM ID

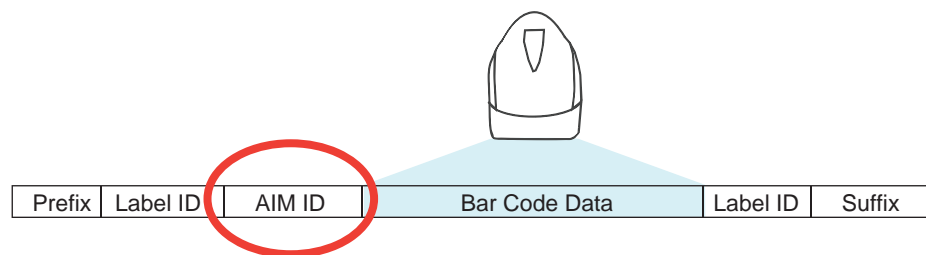

Label ID

A Label ID is a customizable code of up to three ASCII characters (each can be one of hex 0x01–0xFF), used to identify a bar code (symbology) type. It can be appended previous to or following the transmitted bar code data depending upon how this option is enabled. This feature provides options for configuring custom Label IDs as a pre-loaded set or individually per symbology (see "Label ID: Set Individually Per Symbology" on page 53). If you wish to program the scanner to always include an industry standard label identifier for ALL symbology types, see "Global AIM ID" on page 51.

Label ID: Pre-loaded Sets

The following table lists the pre-loaded label ID sets for the USA and Europe.

Table 12. Label ID Pre-loaded Sets

Symbology	USA Label ID set		EU Label ID set	
	ASCII character	Hex value	ASCII character	Hexadecimal value
ABC Codabar	S	530000	S	530000
CODABAR	%	250000	R	520000
Codablock F	l	6C0000	m	6D0000
Code 39 CIP	Y	590000	Y	590000
Code 93	&	260000	U	550000
CODE11	CE	434500	b	620000
CODE128	#	230000	T	540000
CODE32	A	410000	X	580000
CODE39	*	2A0000	V	560000
CODE4	4	340000	4	340000
CODE5	j	6A0000	j	6A0000
CODE93	&	260000	U	550000
DATALOGIC 20F5	s	730000	s	730000
EAN13	F	460000	B	420000
EAN13 P2	F	460000	L	4C0000
EAN13 P5	F	460000	M	4D0000
EAN8	FF	464600	A	410000
EAN8 P2	FF	464600	J	4A0000
EAN8 P5	FF	464600	K	4B0000
FOLLETT 20F5	O	4F0000	O	4F0000
GS1 DATABAR EXPANDED	RX	525800	t	740000

Symbology	USA Label ID set		EU Label ID set	
GS1 DATABAR LIMITED	RL	524C00	v	760000
GS1 DATABAR OMNIDIRECTIONAL	R4	523400	u	750000
GS1-128		000000	k	6B0000
I2OF5	i	690000	N	4E0000
IATA	IA	494100	&	260000
Industrial 2 of 5	W	570000	W	570000
Interleaved 2 of 5 CIP HR	e	650000	e	650000
ISBN	l	490000	@	400000
ISBT128	f	660000	f	660000
ISSN	n	6E0000	n	6E0000
MSI	@	400000	Z	5A0000
S25	s	730000	P	500000
UPCA	A	410000	C	430000
UPCA P2	A	410000	F	460000
UPCA P5	A	410000	G	470000
UPCE	E	450000	D	440000
UPCE P2	E	450000	H	480000
UPCE P5	E	450000	I	490000

Label ID: Set Individually Per Symbology

To configure a Label ID individually for a single symbology:

1. Scan the ENTER/EXIT bar code.
2. Select Label ID position as either BEFORE (Enable as Prefix) or AFTER (Enable as suffix) by scanning the appropriate bar code in the section "Label ID Control" on page 53. Reference Figure 7 for Label ID positioning options if multiple identification features are enabled.
3. Scan a bar code to select the symbology for which you wish to configure a custom Label ID from the section [Label ID Symbology Selection, starting on page 54](#).
4. Determine the desired character(s) (you may choose up to three) which will represent the Label ID for the selected symbology.
5. Turn to the [ASCII Chart on page 287](#) on the inside back cover of this manual and find the equivalent hex digits associated with your choice of Label ID. For example, if you wish to select an equal sign (=) as a Label ID, the chart indicates its associated hex characters as 3D. Turn to [Keypad, starting on page 275](#) and scan the bar codes representing the hex characters determined. For the example given, the characters '3' and 'D' would be scanned. More examples of Label ID settings are provided in [Table 13](#).



NOTE

If you make a mistake before the last character, scan the CANCEL bar code to abort and not save the entry string. You can then start again at the beginning.

6. Scan the ENTER/EXIT bar code to exit Label ID entry.
7. Scan the ENTER/EXIT bar code once again to exit Programming Mode.

This completes the steps to configure a Label ID for a given symbology.

Figure 7. Label ID Position Options

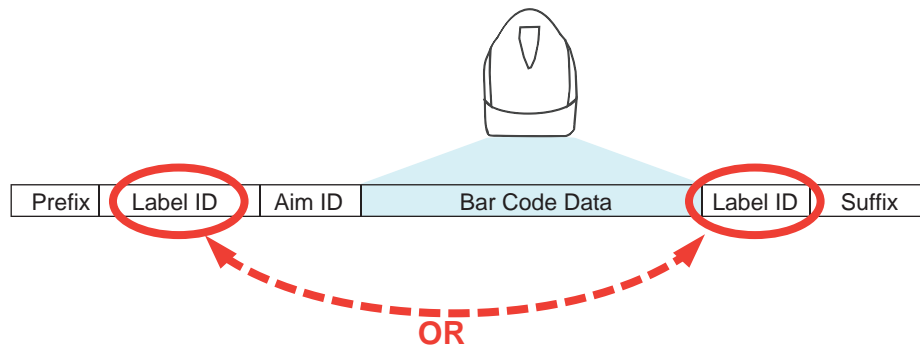

Label ID: Set Individually Per Symbology — continued

Table 13. Label ID Examples

STEP	ACTION	EXAMPLES			
1.	Scan the ENTER/EXIT bar code	(Scanner enters Programming Mode)			
2.	Determine placement of the Label ID characters BEFORE or AFTER with regard to scanned data using "Label ID Control" on page 53	Enable as Prefix	Enable as Suffix	Enable as Prefix	Enable as Suffix
3.	Scan the bar code selecting the symbology type you wish to designate label ID characters for using Label ID Symbology Selection, starting on page 54.	GS1 DataBar Omnidirectional	Code 39	Interleaved 2 of 5	Code 32
4.	Custom Label ID example (desired characters):	D B *	= C 3	+	P H
5.	Find hex equivalents from the ASCII table (inside back cover), then scan in these digits/characters using the bar codes in the section: Keypad, starting on page 275. If you make a mistake before the last character, scan the CANCEL bar code to abort and not save the entry string. You can then start again at the beginning.	44 42 2A	3D 43 33	2B	50 48
6.	Scan the ENTER/EXIT bar code	(Scanner exits Label ID entry)			
7.	Scan the ENTER/EXIT bar code once again	(Scanner exits Programming Mode)			
Result:					
		DB*[bar code data]	[bar code data]=C3	+ [bar code data]	[bar code data]PH

Character Conversion

Character conversion is an eight byte configuration item. The eight bytes are 4 character pairs represented in hexadecimal ASCII values. The first character in the pair is the character that will be converted. The second character in the pair is the character to convert to. If the character to convert in a pair is FF, then no conversion is done.

For example, if you have the character conversion configuration item set to the following: 41423132FFFFFFFF

The first pair is 4142 or AB (41 hex is an ASCII capital A, 42 hex is an ASCII capital B) and the second pair is 3132 or 12 (31 hex is an ASCII 1, 32 is an ASCII 2). The other two pairs are FFFF and FFFF.

With the label, AB12BA21, it would look as follows after the character conversion: BB22BB22.

The A characters were converted to B characters and the 1 characters were converted to 2 characters. Nothing is done with the last two character pairs, since they are all FF.

To set Character Conversion:

1. Scan the ENTER/EXIT bar code.
2. Scan the bar code for "Character Conversion" on page 60
3. Determine the desired string. Sixteen positions must be determined as in the above example. Next, turn to the [ASCII Chart on page 287](#) on the inside back cover of this manual and find the equivalent hex digits needed to fulfill the string.
4. Turn to [Appendix D, Keypad](#) and scan the bar codes representing the hex characters determined in the previous step.
5. Scan the ENTER/EXIT bar code to exit Programming Mode.



NOTE

If less than the expected string of 16 characters are selected, scan the ENTER/EXIT bar code twice to accept the selections and exit Programming Mode.

Reading Parameters

Label Gone Timeout

This feature sets the time after the last label segment is seen before the scanner prepares for a new label. The timeout can be set within a range of 10 milliseconds to 2,550 milliseconds (2.55 seconds) in 10ms increments. Label Gone Timeout does not apply to scan modes that require a trigger pull for each label that is read.

Follow these instructions to set this feature:

1. Determine the desired setting in milliseconds.
2. Divide the desired setting by 10 (setting is in 10ms increments). Pad the result with leading zeroes to yield three digits. For example: 0 = 000, 5 = 005, 20 = 020, etc.
3. Scan the ENTER/EXIT PROGRAMMING MODE bar code to enter Programming Mode.
4. Scan the bar code: SELECT LABEL GONE TIMEOUT SETTING on [page 83](#).
5. Scan the appropriate three alpha-numeric characters from the keypad in [Appendix D, Keypad](#) representing the duration which was determined in the steps above. You will hear a two-beep indication after the last character.



NOTE

If you make a mistake before the last character, scan the **CANCEL** bar code to abort and not save the entry string. You can then start again at the beginning.

6. Scan the ENTER/EXIT PROGRAMMING MODE bar code to exit Programming Mode.

This completes the procedure. See the table below for examples of how to set this feature.

Table 14. Label Gone Timeout Setting Examples

STEP	ACTION	EXAMPLES			
1	Desired Setting	50ms	150ms	1800ms (1.8 sec.)	2550ms (2.55 sec.)
2	Divide by 10 (and pad with leading zeroes)	005	015	180	255
3	Scan ENTER/EXIT PROGRAMMING MODE				
4	Scan SELECT LABEL GONE TIMEOUT SETTING				
5	Scan Three Characters From Appendix D, Keypad	'0', '0' and '5'	'0', '1' and '5'	'1', '8' and '0'	"2", '5' and '5'
6	Scan ENTER/EXIT PROGRAMMING MODE				

RGB LED Features

RGB Good Read Raising/Falling Time

This parameter specifies the time it will take for the RGB good read to change the status from an Off state to Brightness state, or back.

The delay can be set within a range of zero (0) to 5000 milliseconds (5 seconds) in 100ms increments. A setting of zero specifies no delay.

To set the time:

1. Determine the desired setting in milliseconds.
2. Divide the desired setting by 100 (setting is in 100ms increments). Pad the result with leading zeroes to yield two digits. For example: 0 = 00, 5 = 05, 20 = 20, etc.
3. Scan the ENTER/EXIT PROGRAMMING MODE bar code to enter Programming Mode.
4. Scan the bar code: SELECT RGB GOOD READ RAISING TIME on [page 77](#) or RBG GOOD READ FALLING TIME on [page 78](#).
5. Scan the appropriate two digits from the keypad in [Appendix D, Keypad](#), that represent the duration which was determined in the steps above.



NOTE

If you make a mistake before the last character, scan the CANCEL bar code to abort and not save the entry string. You can then start again at the beginning.

6. Scan the ENTER/EXIT PROGRAMMING MODE bar code to exit.

This completes the procedure. See the following table for examples of how to set this feature.

Table 15. RGB Good Read Raising/Falling Time Examples

STEP	ACTION	EXAMPLES			
1	Desired Setting	100ms	200ms	1000ms (1 sec.)	5000ms (5 secs.)
2	Divide by 100	01	02	10	50
3	Scan ENTER/EXIT PROGRAMMING MODE				
4	Scan SELECT RGB GOOD READ RAISING/FALLING TIME				
5	Scan Two Characters From Appendix D, Keypad	'0' and '1'	'0' and '2'	'1' and '0'	'5' and '0'
6	Scan ENTER/EXIT PROGRAMMING MODE				

RGB Good Read Holding Time

This parameter specifies the time it will take for the RGB good read to change the status from an Off state to Brightness state.

The delay can be set within a range of zero (0) to 255 milliseconds (25.5 seconds) in 100ms increments. A setting of zero specifies no delay.

To set the time:

1. Determine the desired setting in milliseconds.
2. Divide the desired setting by 100 (setting is in 100ms increments). Pad the result with leading zeroes to yield two digits. For example: 0 = 00, 5 = 05, 20 = 20, etc.
3. Scan the ENTER/EXIT PROGRAMMING MODE bar code to enter Programming Mode.
4. Go to [page 78](#) and scan the bar code: SELECT RGB GOOD READ HOLDING TIME.
5. Scan the appropriate two digits from the keypad in [Appendix D, Keypad](#), that represent the duration which was determined in the steps above.



NOTE

If you make a mistake before the last character, scan the CANCEL bar code to abort and not save the entry string. You can then start again at the beginning.

6. Scan the ENTER/EXIT PROGRAMMING MODE bar code to exit.

This completes the procedure. See the following table for examples of how to set this feature.

Table 16. RGB Good Read Holding Time Examples

STEP	ACTION	EXAMPLES			
1	Desired Setting	100ms	200ms	1,000ms (1 sec.)	5,000ms (5 secs.)
2	Divide by 100	01	02	10	50
3	Scan ENTER/EXIT PROGRAMMING MODE				
4	Scan SELECT RGB GOOD READ HOLDING TIME				
5	Scan Two Characters From Appendix D, Keypad	'0' and '1'	'0' and '2'	'1' and '0'	'5' and '0'
6	Scan ENTER/EXIT PROGRAMMING MODE				

RGB Auto Delay Time

Specifies the delay time for running the RGB auto mode after the scanner has gone into an idle state (no label reading, label programming or communication with Host).

The delay can be set within a range of zero (0) to 255 milliseconds (5 seconds) in 500ms increments. The value 0x00 means Auto Mode is disabled.

To set the time:

1. Determine the desired setting in milliseconds.
2. Divide the desired setting by 500 (setting is in 500ms increments). Pad the result with leading zeroes to yield two digits. For example: 0 = 00, 5 = 05, 20 = 20, etc.
3. Scan the ENTER/EXIT PROGRAMMING MODE bar code to enter Programming Mode.
4. Go to [page 79](#) and scan the bar code: SELECT RGB AUTO DELAY TIME.
5. Scan the appropriate two digits from the keypad in [Appendix D, Keypad](#), that represent the duration which was determined in the steps above.



NOTE

If you make a mistake before the last character, scan the **CANCEL** bar code to abort and not save the entry string. You can then start again at the beginning.

6. Scan the ENTER/EXIT PROGRAMMING MODE bar code to exit.

This completes the procedure. See the following table for examples of how to set this feature.

Table 17. RGB Auto Delay Examples

STEP	ACTION	EXAMPLES			
1	Desired Setting	500ms	1,000ms (1 sec.)	10,000ms (10 sec.)	60,000ms (60 secs.)
2	Divide by 500	01	02	20	120
3	Scan ENTER/EXIT PROGRAMMING MODE				
4	Scan SELECT RGB AUTO DELAY TIME				
5	Scan Two Characters From Appendix D, Keypad	'0' and '1'	'0' and '2'	'2' and '0'	'1', '2' and '0'
6	Scan ENTER/EXIT PROGRAMMING MODE				

Scanning Features

Scan Mode

Selects the scan operating mode for the reader. Selections are:

Trigger Single: When the trigger is pulled, scanning is activated until one of the following occurs:

- **Scanning Active Time** has elapsed
- a label has been read
- the trigger is released

This mode is associated with typical handheld reader operation: when the trigger is pulled, scanning starts and the product scans until the trigger is released, or a label is read, or the maximum **Scanning Active Time** has elapsed.

Trigger Hold Multiple : When the trigger is pulled, scanning starts and the product scans until the trigger is released or **Scanning Active Time** has elapsed. Reading a label does not disable scanning. **Double Read Timeout** prevents undesired multiple reads of the same label while in this mode.

Trigger Pulse Multiple: When the trigger is pulled, continuous scanning is activated until **Scanning Active Time** has elapsed or the trigger has been released and pulled again. **Double Read Timeout** prevents undesired multiple reads of the same label while in this mode.

Flashing: The reader flashes¹ on and off regardless of the trigger status. Flash rate is controlled by **Flash On Time** and **Flash Off Time**. When Flash is ON the reader reads continuously. When Flash is OFF scanning is deactivated.

Always On: No trigger pull is required to read a bar code. Scanning is continually on. **Double Read Timeout** prevents undesired multiple reads of the same label while in this mode.

Stand Mode: No trigger pull is required to read a bar code. Scanning turns on automatically when an item is placed in reader's field of view. While in a stand watch state, the reader illumination LED goes from dim to maximum bright.

¹Controlled by **Flash On Time**.

Scanning Active Time

This setting specifies the amount of time that the reader stays in scan ON state once the state is entered. The range for this setting is from 1 to 255 seconds in 1-second increments.

Follow these instructions to set this feature:

1. Determine the desired setting.
2. Pad the result with leading zeroes to yield three digits. For example: 0 = 000, 5 = 005, 20 = 020, etc.
3. Scan the ENTER/EXIT PROGRAMMING MODE bar code to enter Programming Mode.
4. Scan the bar code: SELECT SCANNING ACTIVE TIME SETTING on [page 82](#).
5. Scan the appropriate three digits from the keypad in [Appendix D, Keypad](#) that represent the duration which was determined in the steps above. You will hear a two-beep indication after the last character.



NOTE

If you make a mistake before the last character, scan the CANCEL bar code to abort and not save the entry string. You can then start again at the beginning.

6. Scan the ENTER/EXIT PROGRAMMING MODE bar code to exit Programming Mode.

This completes the procedure. See the table below for examples of how to set this feature.

Table 18. Scanning Active Time Setting Examples

STEP	ACTION	EXAMPLES			
1	Desired Setting	1 Second	90 Sec. (1.5 min.)	180 Sec. (3 min.)	255 Seconds (4.25 min.)
2	Pad leading zero(es)	001	090	180	255
3	Scan ENTER/EXIT PROGRAMMING MODE				
4	Scan SELECT SCANNING ACTIVE TIME SETTING				
5	Scan Three Characters From Appendix D, Keypad	'0', '0' and '1'	'0', '9' and '0'	'1', '8' and '0'	'2', '5' and '5'
6	Scan ENTER/EXIT PROGRAMMING MODE				

Flash On Time

This feature specifies the ON time for the indicator LED while in Flash Mode. The selectable range is 100 to 9,900 milliseconds (0.1 to 9.9 seconds), in 100 millisecond increments.

Follow these instructions to set this feature.

1. Determine the desired setting in milliseconds.
2. Divide the desired setting by 100 (setting is in 100ms increments). Pad the result with leading zeroes to yield two digits. For example: 0 = 00, 5 = 05, 20 = 20, etc.
3. Scan the ENTER/EXIT PROGRAMMING MODE bar code to enter Programming Mode.
4. Scan the bar code: SELECT FLASH ON TIME SETTING on [page 83](#)
5. Scan the appropriate two digits from the keypad in [Appendix D, Keypad](#) representing the duration which was determined in the steps above. You will hear a two-beep indication after the last character.



NOTE

If you make a mistake before the last character, scan the CANCEL bar code to abort and not save the entry string. You can then start again at the beginning.

6. Scan the ENTER/EXIT PROGRAMMING MODE bar code to exit Programming Mode.

This completes the procedure. See the table below for examples of how to set this feature.

Table 19. Flash On Time Setting Examples

STEP	ACTION	EXAMPLES			
1	Desired Setting	500ms	1,000ms (1 sec.)	5200ms (5.2 sec.)	9,900ms (9.9 sec.)
2	Divide by 100 (and pad with leading zeroes to yield two digits)	05	10	52	99
3	Scan ENTER/EXIT PROGRAMMING MODE				
4	Scan SELECT FLASH ON TIME SETTING				
5	Scan Two Characters From Appendix D, Keypad	'0' and '5'	'1' and '0'	'5' and '2'	'9' and '9'
6	Scan ENTER/EXIT PROGRAMMING MODE				

Flash Off Time

This feature specifies the OFF time for the indicator LED while in Flash Mode. The selectable range is 100 to 9,900 milliseconds (0.1 to 9.9 seconds), in 100 millisecond increments.

Follow these instructions to set this feature.

1. Determine the desired setting in milliseconds.
2. Divide the desired setting by 100 (setting is in 100ms increments). Pad the result with leading zeroes to yield two digits. For example: 0 = 00, 5 = 05, 20 = 20, etc.
3. Scan the ENTER/EXIT PROGRAMMING MODE bar code to enter Programming Mode.
4. Scan the bar code: SELECT FLASH OFF TIME SETTING on [page 84](#).
5. Scan the appropriate two digits from the keypad in [Appendix D, Keypad](#), that represent the duration which was determined in the steps above. You will hear a two-beep indication after the last character.



NOTE

If you make a mistake before the last character, scan the CANCEL bar code to abort and not save the entry string. You can then start again at the beginning.

6. Scan the ENTER/EXIT PROGRAMMING MODE bar code to exit Programming Mode.

This completes the procedure. See the table below for examples of how to set this feature.

Table 20. Flash Off Time Setting Examples

STEP	ACTION	EXAMPLES			
1	Desired Setting	500ms	1,000ms (1 sec.)	5200ms (5.2 sec.)	9,900ms (9.9 sec.)
2	Divide by 100 (and pad with leading zeroes to yield two digits)	05	10	52	99
3	Scan ENTER/EXIT PROGRAMMING MODE				
4	Scan SELECT FLASH OFF TIME SETTING				
5	Scan Two Characters From Appendix D, Keypad	'0' and '5'	'1' and '0'	'5' and '2'	'9' and '9'
6	Scan ENTER/EXIT PROGRAMMING MODE				

Symbologies

Decoding Levels

Decoding Levels are used to configure a bar code symbology decoder to be very aggressive to very conservative depending on a particular customer's needs.

- Choosing Level 1 results in a very conservative decoder at the expense of not being able to read poorly printed or damaged labels.
- Choosing Level 5 results in a very aggressive decoder. This aggressive behavior allows decoding of poorly printed and damaged labels at the expense of increasing the likelihood of decoding errors.
- Choosing Level 3, which is the default setting, allows the majority of product labels to be decoded.

There are many factors that determine when to change the decoding level for a particular symbology. These factors include spots, voids, non-uniform bar/space widths, damaged labels, etc. that may be experienced in some bar code labels. If there are many hard to read or damaged labels that cannot be decoded using a conservative setting, increase the decoding level to be more aggressive. If the majority of labels are very good quality labels, or there is a need to decrease the possibility of a decoder error, lower the decoding level to a more conservative level.

Set Length

Length Control allows you to select either variable length decoding or fixed length decoding for the specified symbology.

Variable Length: For variable length decoding, a minimum and maximum length may be set.

Fixed Length: For fixed length decoding, two different lengths may be set.

Set Length 1

This feature specifies one of the bar code lengths for a given symbology. Length 1 is the minimum label length if in Variable Length Mode, or the first fixed length if in Fixed Length Mode.

Reference the [Symbologies on page 85](#) section to view the selectable range (number of characters) for the symbology being set.

Follow these instructions to set this feature:

1. Determine the desired character length. Pad the number with leading zeroes to yield two digits. For example: 0 = 00, 5 = 05, 20 = 20, etc.
2. Scan the ENTER/EXIT PROGRAMMING MODE bar code to enter Programming Mode.
3. Scan the "Select Length 1 Setting" for the symbology being set.

4. Scan the appropriate two digits from the keypad in [Appendix D, Keypad](#), that represent the length setting which was determined in the steps above. You will hear a two-beep indication after the last character.

**NOTE**

If you make a mistake before the last character, scan the **CANCEL** bar code to abort and not save the entry string. You can then start again at the beginning.

5. Scan the ENTER/EXIT PROGRAMMING MODE bar code to exit Programming Mode.

This completes the procedure. See the table below for examples of how to set this feature.

Table 21. Length 1 Setting Examples

STEP	ACTION	EXAMPLES			
1	Desired Setting	01 Character	07 Characters	52 Characters	74 Characters
2	Scan ENTER/EXIT PROGRAMMING MODE				
3	Scan SELECT LENGTH 1SETTING for the desired symbology				
4	Scan Two Characters From Appendix D, Keypad	'0' and '1'	'0' and '7'	'5' and '2'	'7' AND '4'
5	Scan ENTER/EXIT PROGRAMMING MODE				

Set Length 2

This feature specifies one of the bar code lengths for a given symbology. Length 2 is the maximum label length if in Variable Length Mode, or the second fixed length if in Fixed Length Mode.

Reference the [Symbologies on page 85](#) section to view the selectable range (number of characters) for the symbology being set. A setting of 00 specifies to ignore this length (only one fixed length).

Follow these instructions to set this feature:

1. Determine the desired character length. Pad the number with leading zeroes to yield two digits. For example: 0 = 00, 5 = 05, 20 = 20, etc.
2. Scan the ENTER/EXIT PROGRAMMING MODE bar code to enter Programming Mode.
3. Scan the “Select Length 2 Setting” for the symbology being set.
4. Scan the appropriate two digits from the keypad in [Appendix D, Keypad](#), that represent the length setting which was determined in the steps above. You will hear a two-beep indication after the last character.



NOTE

If you make a mistake before the last character, scan the CANCEL bar code to abort and not save the entry string. You can then start again at the beginning.

5. Scan the ENTER/EXIT PROGRAMMING MODE bar code to exit Programming Mode.

This completes the procedure. See the table below for examples of how to set this feature.

Table 22. Length 2 Setting Examples

STEP	ACTION	EXAMPLES			
1	Desired Setting	00 (ignore second length)	07 Characters	52 Characters	74 Characters
2	Scan ENTER/EXIT PROGRAMMING MODE				
3	Scan SELECT LENGTH 2 SETTING				
4	Scan Two Characters From Appendix D, Keypad	'0' and '0'	'0' and '7'	'5' and '2'	'7' and '4'
5	Scan ENTER/EXIT PROGRAMMING MODE				

NOTES



Appendix A

Technical Specifications

The table below contains Physical and Performance Characteristics, User Environment and Regulatory information. [Table 25](#) provides Standard Cable Pinouts.

Table 23. Technical Specifications

Item	Description
Electrical Features	
Power Supply RS-232 interface	5 Vdc \pm 5%
Consumption:	Max operating current @ 5V: <500 mA Typical operating (changing colors) current @ 5V < 300 mA
Max. Scan Rate	270 scans/sec
Reading Indicators	Side and Top Illumination, Good Read Spot, Beep or Jingle
Optical Features	
Sensor	CCD solid state (2500 pixels)
Illuminator	LED array
Wavelength	617 nm
LED Safety Class	Exempt according to IEC 62471
DOF (Depth of Field) Typical	5 mils : 5 to 15.0 cm / 2.0 to 6.0 in (CODE 39, PCS 90%) 10 mils: 2 to 35.0 cm / 0,8 to 13.8 in (CODE 39, PCS 90%) 13 mils: 2 to 40.0 cm / 0,8 to 15.7 in (EAN13, PCS 90%) 20 mils: 2 to 60.0 cm / 0,8 to 23.6 in (CODE 39, PCS 90%)
Max. Resolution	0.10 mm (4 mils)
PCS (Datalogic Test Chart)	minimum 15%

Item	Description
Environmental Features	
Working Temperature	0 °C to + 50 °C (+32° to +122 °F)
Storage Temperature	-20 °C to + 70 °C (-4° to +158 °F)
Humidity	90% non condensing
Drop Resistance	IEC 68-2-32 Test ED 1.5 m (5 ft)
ESD Protection	16 KV
Protection Class	IP40
Mechanical Features	
Weight (without cable)	approx. 150 g (5.3 oz)
Cable Length	Refer to www.datalogic.com
Decode Capability	UPC/EAN, P2 /P5 add-ons; ISBN; ISSN; GTIN, add on 2/5; Codabar; ABC Codabar; Interleaved 2/5; Code 93; Code 128; Code 39; Code 32 (Italian Pharmacode); Code 11; Industrial 2/5; IATA Industrial 2/5; EAN 128; Code 4; Code 5; China Post (Datalogic 2 of 5); Standard 2 of 5; MSI; Concatenated ISBT 128 STACKED CODES: GS1 DataBar Expanded; GS1 DataBar Limited; GS1 DataBar Omnidirectional

LED and Beeper Indications

The imager's beeper sounds and its illumination flashes or changes color to indicate various functions or errors on the reader. A "Green Spot" also lights to indicate a good read. The tables below list these indications.

Table 24. LED and Speaker Indications

Indication	LED	Beeper	Indication
Power-up	Upper LED flashes/blinks on power-up, however, this may be too rapid to view. With a USB interface, the LED blinks until enumeration with the host is completed.	Imager beeps four times at highest frequency and volume upon power-up.	Power-up
Good Read	Upper green LED comes on for programmed time (default). LED behavior for this indication is configurable using Aladdin utility.	One beep at current frequency, volume, mono/bi-tonal setting upon a successful label scan. It is also possible to upload custom jingles with Aladdin.	Good Read
ROM Failure	200ms on / 200ms off	Imager sounds one error beep at highest volume for 200 mS.	ROM Failure
Limited Scanning Label Read	N/A	Imager 'chirps' six times at the highest frequency and current volume.	Limited Scanning Label Read
Imager Disabled	The LED blinks continuously 100mS on / 900 mS off	N/A	Imager Disabled

Programming Mode

The following indications ONLY occur when the scanner is in Programming Mode.

INDICATION	DESCRIPTION	LED	SPEAKER
Label Programming Mode Entry	A valid programming label has been scanned.	LED blinks continuously	Scanner sounds four low frequency beeps.
Label Programming Mode Rejection of Label	A label has been rejected.	N/A	Scanner sounds three times at lowest frequency & current volume.
Label Programming Mode Acceptance of Partial Label	In cases where multiple labels must be scanned to program one feature, this indication acknowledges each portion as it is successfully scanned.	N/A	Scanner sounds one short beep at highest frequency & current volume.
Label Programming Mode Acceptance of Programming	Configuration option(s) have been successfully programmed via labels and the scanner has exited Programming Mode.	N/A	Scanner sounds one high frequency beep and 4 low frequency beeps followed by reset beeps.
Label Programming Mode Cancel Item Entry	Cancel label has been scanned.	N/A	Scanner sounds two times at low frequency and current volume.

Troubleshooting

Problem	Possible Cause	Possible Solutions
Nothing happens when the scan button is pulled.	No power to the imager.	Check system power. Ensure power supply is connected.
	Interface or power cables are loose.	Ensure all cable connections are secure.
LED comes on, but bar code does not decode.	Imager not programmed for correct bar code type.	Ensure imager is programmed to read the type of bar code scanned. Refer to the PRG for more information.
	Bar code label is unreadable.	Check the label to ensure it is not defaced. Try scanning another bar code type.
	Distance between imager and bar code is incorrect.	Move imager closer to or further from the bar code.
Bar code is decoded but not transmitted to the host.	Imager not programmed for the correct host type.	Scan the appropriate host type bar code. Refer to the PRG for more information.

Error Codes

Upon startup, if the scanner sounds a long tone, this means the scanner has not passed its automatic Selftest and has entered FRU (Field Replaceable Unit) isolation mode. If the scanner is reset, the sequence will be repeated. The following table describes the LED flashes/beep codes associated with an error found.

NUMBER OF LED FLASHES/ BEEPS	ERROR	CORRECTIVE ACTION
1	Configuration	Contact Helpdesk for assistance
2	Interface PCB	
5	[Reserved]	
6	Digital PCB	

Standard Cable Pinouts

Figure 8 and Table 25 provide standard pinout information for the scanner's cable.

Figure 8. Standard Cable Pinouts

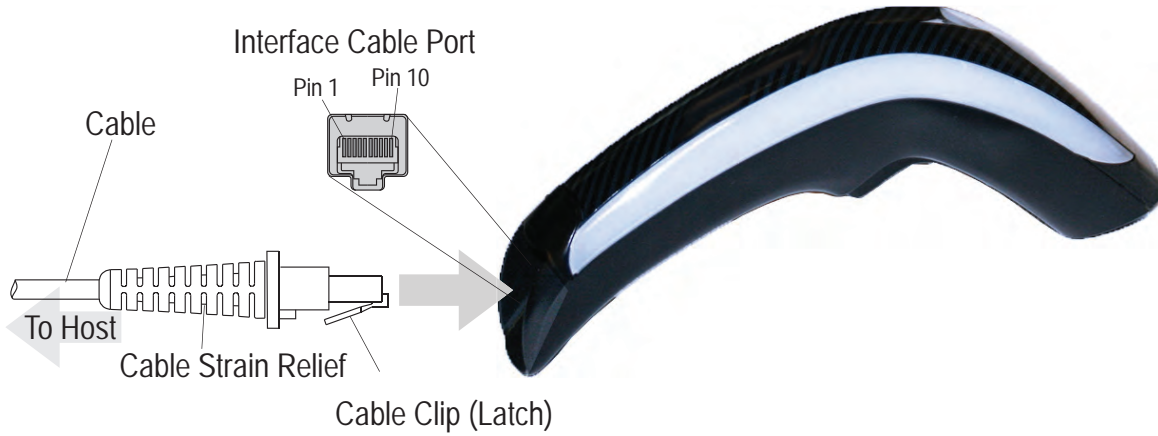

The signal descriptions in Table 25 apply to the connector on the scanner and are for reference only.

Table 25. Standard Cable Pinouts — Scanner Side

Pin	RS-232	USB	Keyboard Wedge
1	RTS (out)		
2		D+	CLKIN (KBD side)
3		D-	DATAIN (KBD side)
4	GND	GND	GND
5	RX		
6	TX		
7	VCC	VCC	VCC
8			CLKOUT (PC side)
9			DATAOUT (PC side)
10	CTS (in)		

Stand Dimensions

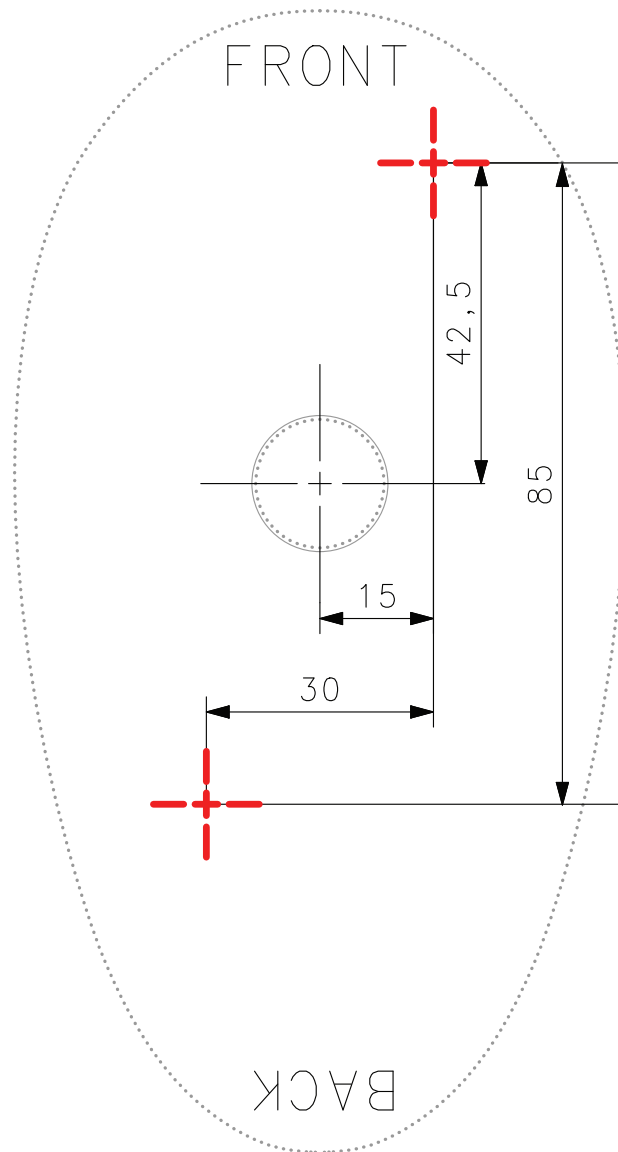

Stand Base Plate Template





Appendix B Standard Defaults

The most common configuration settings are listed in the “Default” column of Table 26. The settings in this table are as applied to a standard RS-232 interface. See Table 27 for a listing of default exceptions to this list as applied to other interface types. Page references are also provided for feature descriptions and programming bar codes for each parameter. A column has also been provided for recording of your preferred default settings for these same configurable features.

Table 26. Standard Defaults

Parameter	Default	Your Setting	Page Number
GLOBAL INTERFACE FEATURES			
Host Commands — Obey/Ignore	Obey		19
USB Suspend Mode	Disable		20
RS-232			
Baud Rate	9600		21
Stop Bits	1 Stop Bit		22
Parity	None		23
Handshaking Control	RTS		24
RS-232/USB-COM			
Intercharacter Delay	No Delay		26
Beep On ASCII BEL	Disable		27
Beep On Not on File	Enable		27
ACK Character	'ACK'		29
NAK Character	'NAK'		29
ACK NAK Timeout Value	600 ms		30

Parameter	Default	Your Setting	Page Number
ACK NAK Retry Count	3 Retries		31
ACK NAK Error Handling	Ignore Errors Detected		32
Indicate Transmission Failure	Enable		33
Disable Character	'D'		33
Enable Character	'E'		34
KEYBOARD WEDGE			
Country Mode	U.S. Keyboard		36
Caps Lock State	Caps Lock OFF		39
Numlock	Numlock Key Unchanged		39
Keyboard Numeric Keypad	Standard Keys		40
Keyboard Send Control Characters	Disable		41
Wedge Quiet Interval	100ms		42
Intercharacter Delay	No Delay		43
Intercode Delay	100 ms		44
USB Keyboard Speed	1 ms		45
USB-OEM			
USB-OEM Device Usage	Handheld Scanner		48
USB-OEM Interface Options	Ignore		48
DATA FORMAT			
Global Prefix/Suffix	No Global Prefix Global Suffix = 0x0D (CR)		50
Global AIM ID	Disable		51
GS1-128 AIM ID	Enable		51
Label ID Control	Disable		53
Case Conversion	Disable		60
Character Conversion	No Char Conversion		60
READING PARAMETERS			
Double Read Timeout	0.6 Second		62

Parameter	Default	Your Setting	Page Number
Label Gone Timeout	160 ms		64
Label Gone Timeout	160 ms		64
LED and SPEAKER Indications			
Power On Alert	4 Beeps		65
Good Read: When to Indicate	After Decode		72
Good Read Beep Type	Mono		73
Good Read Beep Frequency	Medium		73
Good Read Speaker Volume	High		74
Good Read Beep Length	80 ms		75
RGB LED Features			
Enable/Disable RGB LED	Enable		76
Good Read LED Color	Green		77
RGB Good Read Raising Time	00		77
RGB Good Read Falling Time	14		78
RGB Good Read Holding Time	14		78
RGB Auto Delay	04		79
SCANNING FEATURES			
Scan Mode	Trigger Single		80
Stand Mode Triggered Timeout	0.5 Seconds		81
Scanning Active Time	5 Seconds		82
Stand Mode Flash	Disable		83
Flash On Time	1 Second		83
Flash Off Time	600 ms		84
Stand Mode Sensitivity	Medium		84
SYMBOLOGIES			
Coupon Control	Enable only UPC/ EAN		86
UPC-A			
UPC-A Enable/Disable	Enable		87

Parameter	Default	Your Setting	Page Number
UPC-A Check Character Transmission	Enable		87
Expand UPC-A to EAN-13	Don't Expand		88
UPC-A Number System Character Transmission	Transmit		88
In-Store Minimum Reads	2		89
UPC-E			
UPC-E Enable/Disable	Enable		90
UPC-E Check Character Transmission	Send		90
Expand UPC-E to EAN-13	Don't Expand		91
Expand UPC-E to UPC-A	Don't Expand		91
UPC-E Number System Character Transmission	Transmit		92
UPC-E Minimum Read	2		92
EAN 13			
EAN 13 Enable/Disable	Enable		93
EAN 13 Check Character Transmission	Send		93
EAN-13 Flag 1 Character	Transmit		94
EAN-13 ISBN Conversion	Disable		94
ISSN Enable/Disable	Disable		95
EAN 13 Minimum Reads	1		95
EAN 8			
EAN 8 Enable/Disable	Enable		96
EAN 8 Check Character Transmission	Send		96
Expand EAN 8 to EAN 13	Disable		97
EAN 8 Minimum Reads	1		97
UPC/EAN Global Settings			
UPC/EAN Decoding Level	2		98
UPC/EAN Price Weight Check	Disable		99

Parameter	Default	Your Setting	Page Number
UPC-A Minimum Reads	1 Read		100
Add-ons			
Optional Add-ons	Disable P2, P5 and P8		101
Optional Add-On Timer	70 ms		102
P2 Add-Ons Minimum Reads	2		103
P5 Add-Ons Minimum Reads	1		104
GS1 DataBar Omnidirectional			
GS1 DataBar Omnidirectional Enable/Disable	Disable		105
GS1 DataBar Omnidirectional GS1-128 Emulation	Disable		105
GS1 DataBar Omnidirectional Minimum Reads	1		106
GS1 DataBar Expanded			
GS1 DataBar Expanded Enable/Disable	Disable		107
GS1 DataBar Expanded GS1-128 Emulation	Disable		107
GS1 DataBar Expanded Minimum Reads	1		108
GS1 DataBar Expanded Length Control	Variable		109
GS1 DataBar Expanded Set Length 1	1		109
GS1 DataBar Expanded Set Length 2	74		110
GS1 DataBar Limited			
GS1 DataBar Limited Enable/Disable	Disable		111
GS1 DataBar Limited GS1-128 Emulation	Disable		111
GS1 DataBar Limited Minimum Reads	1		112

Parameter	Default	Your Setting	Page Number
Code 39			
Code 39 Enable/Disable	Enable		113
Code 39 Check Character Calculation	Don't Calculate		114
Code 39 Check Character Transmission	Send		115
Code 39 Start/Stop Character Transmission	Don't Transmit		115
Code 39 Full ASCII	Disable		116
Code 39 Quiet Zones	Auto		117
Code 39 Minimum Reads	2		118
Code 39 Decoding Level	3		119
Code 39 Length Control	Variable		120
Code 39 Set Length 1	2		121
Code 39 Set Length 2	50		122
Code 39 Interdigit Ratio	4		123
Code 32			
Code 32 Enable/Disable	Disable		125
Code 32 Check Character Transmission	Don't Send		126
Code 32 Start/Stop Character Transmission	Don't Transmit		126
Code 39 CIP			
Code 39 CIP Enable/Disable	Disable		127
Code 128			
Code 128 Enable/Disable	Enable		127
Expand Code 128 to Code 39	Don't Expand		128
Code 128 Check Character Transmission	Don't Send		128
Code 128 Quiet Zones	Auto		130
Code 128 Minimum Reads	1		131
Code 128 Decoding Level	3		132

Parameter	Default	Your Setting	Page Number
Code 128 Length Control	Variable		133
Code 128 Set Length 1	1		134
Code 128 Set Length 2	80		135
Code 128 Stitching	Enable		135
GS1-128			
GS1-128 Enable	Transmit in Code 128 Data Format		136
Interleaved 2 of 5			
I 2 of 5 Enable/Disable	Disable		137
I 2 of 5 Check Character Calculation	Disable		138
I 2 of 5 Check Character Transmission	Send		139
I 2 of 5 Minimum Reads	2		147
I 2 of 5 Decoding Level	3		141
I 2 of 5 Length Control	Variable		142
I 2 of 5 Set Length 1	6		143
I 2 of 5 Set Length 2	50		144
Interleaved 2 of 5 CIP			
Interleaved 2 of 5 CIP HR Enable/Disable	Disable		145
Datalogic 2 of 5			
Datalogic 2 of 5 Enable/Disable	Enable		146
Datalogic 2 of 5 Check Character Calculation	Disable		146
Datalogic 2 of 5 Check Character Transmission	Don't Send		147
Datalogic 2 of 5 Minimum Reads	2		147
Datalogic 2 of 5 Length Control	Variable		148
Datalogic 2 of 5 Set Length 1	12		149
Datalogic 2 of 5 Set Length 2	100		150
Datalogic 2 of 5 Interdigit Ratio	4		151

Parameter	Default	Your Setting	Page Number
Codabar			
Codabar Enable/Disable	Disable		153
Codabar Check Character Calculation	Don't Calculate		153
Codabar Check Character Transmission	Send		154
Codabar Start/Stop Character Transmission	Transmit		154
Codabar Start/Stop Character Set	abcd/abcd		155
Codabar Start/Stop Character Match	Don't Require Match		155
Codabar Quiet Zones	Auto		156
Codabar Minimum Reads	2		157
Codabar Decoding Level	3		158
Codabar Length Control	Variable		159
Codabar Set Length 1	3		160
Codabar Set Length 2	50		161
Codabar Interdigit Ratio	4		162
ABC Codabar			
ABC Codabar Enable/Disable	Disable		164
ABC Codabar Concatenation Mode	Static		164
ABC Codabar Dynamic Concatenation Timeout	200mS		165
ABC Codabar Force Concatenation	Disable		165
Code 11			
Code 11 Enable/Disable	Disable		166
Code 11 Check Character Calculation	Check C and K		167
Code 11 Check Character Transmission	Send		167
Code 11 Minimum Reads	2		168
Code 11 Length Control	Variable		169
Code 11 Set Length 1	4		169

Parameter	Default	Your Setting	Page Number
Code 11 Set Length 2	50		170
Code 11 Interdigit Ratio	4		171
Code 11 Decoding Level	3		173
Standard 2 of 5			
Standard 2 of 5 Enable/Disable	Disable		174
Standard 2 of 5 Check Character Calculation	Disable		174
Standard 2 of 5 Check Character Transmission	Send		175
Standard 2 of 5 Minimum Reads	2		175
Standard 2 of 5 Decoding Level	3		176
Standard 2 of 5 Length Control	Variable		176
Standard 2 of 5 Set Length 1	8		177
Standard 2 of 5 Set Length 2	50		178
Industrial 2 of 5			
Industrial 2 of 5 Enable/Disable	Disable		179
Industrial 2 of 5 Check Character Calculation	Disable		179
Industrial 2 of 5 Check Character Transmission	Enable		180
Industrial 2 of 5 Length Control	Variable		180
Industrial 2 of 5 Set Length 1	1 Character		181
Industrial 2 of 5 Set Length 2	50 Characters		182
Industrial 2 of 5 Minimum Reads	1 Read		183
IATA			
IATA Enable/Disable	Disable		184
IATA Check Character Transmission	Enable		184
ISBT 128			
ISBT 128 Concatenation	Disable		185
ISBT 128 Concatenation Mode	Static		185

Parameter	Default	Your Setting	Page Number
ISBT 128 Dynamic Concatenation Timeout	200ms		186
ISBT 128 Force Concatenation	Disable		187
ISBT 128 Advanced Concatenation Options	Disable		187
MSI			
MSI Enable/Disable	Disable		188
MSI Check Character Calculation	Enable Mod10		188
MSI Check Character Transmission	Enable		189
MSI Length Control	Variable		189
MSI Set Length 1	1 Character		190
MSI Set Length 2	50 Characters		191
MSI Minimum Reads	4 Reads		192
MSI Decoding Level	Level 3		193
Code 93			
Code 93 Enable/Disable	Disable		194
Code 93 Check Character Calculation	Disable		194
Code 93 Check Character Transmission	Enable		195
Code 93 Length Control	Variable		195
Code 93 Set Length 1	1 Character		197
Code 93 Set Length 2	50 Characters		198
Code 93 Minimum Reads	1 Read		199
Code 93 Decoding Level	Level 3		200
Code 93 Quiet Zones	Auto		201
Codablock F			
Codablock F Enable/Disable	Disable		202
Codablock F EAN Enable/Disable	Disable		202
Codablock F AIM Check	Enable Check C		203
Codablock F Length Control	Variable		203

Parameter	Default	Your Setting	Page Number
Codablock F Set Length 1	3 Characters		204
Codablock F Set Length 2	100 Characters		205
Code 4			
Code 4 Enable/Disable	Disable		206
Code 4 Check Character Transmission	Enable		206
Code 4 Hex to Decimal Conversion	Enable		207
Code 5			
Code 5 Enable/Disable	Disable		207
Code 5 Check Character Transmission	Enable		208
Code 5 Hex to Decimal Conversion	Enable		208
Code 4 and Code 5 Common Configuration Items			
Code 4 and 5 Decoding Level	3		209
Code 4 and Code 5 Minimum Reads	1		210
Follett 2 of 5			
Follett 2 of 5 Enable/Disable	Disable		211
BC412			
BC412 Enable/Disable	Disable		211
BC412 Check Character Calculation	Don't Calculate		212
BC412 Minimum Reads	2 Reads		212
BC412 Decoding Level	3		213
BC412 Length Control	Variable Length		214
BC412 Set Length 1	1 Character		214
BC412 Set Length 2	50 Characters		215

Default Exceptions

Table 27. Default Exceptions by Interface Type

Parameter	Default Exception
Interfaces: USB-OEM	
Global Suffix	No Global Suffix
Double Read Timeout	500 msec
Interfaces: All Keyboard Wedge, USB Keyboard	
No unique settings	
Interface: RS232-WN	
Expand UPC-A to EAN-13	Enable
UPC-E Check Character Transmission	Disable
Parity	Odd Parity
Handshaking Control	RTS/CTS
Transmission Label ID Code	Prefix
GS1-128 AIM ID	Disable
UPCE Label ID Character(s)	C
EAN 8 Label ID Character(s)	B
EAN 13 Label ID Character(s)	A
Code ISBN Label ID Character(s)	A
Code 39 Label ID Character(s)	M
Interleaved 2of5 Label ID Character(s)	I
Code Standard 2/5 Label ID Character(s)	H
Codabar Label ID Character(s)	N
Code 128 Label ID Character(s)	K
GS1-128 Label ID Character(s)	P
Datalogic 2 of 5 Label ID Character(s)	H
ISBT 128 Label ID Character(s)	K
UPCE P2 Label ID Character(s)	C
UPCE/P5 Label ID Character(s)	C
UPCE/GS1-128 Label ID Character(s)	C
EAN8/P2 Label ID Character(s)	B

Parameter	Default Exception
EAN8/P5 Label ID Character(s)	B
EAN8/GS1-128 Label ID Character(s)	B
EAN13/P2 Label ID Character(s)	A
EAN13/P5 Label ID Character(s)	A
EAN13/GS1-128 Label ID Character(s)	A
GS1 DataBar 14 (Omnidirectional) Label ID Character(s)	E
GS1 DataBar Expanded Label ID Character(s)	E
GS1 DataBar Limited Label ID Character(s)	E
Character Conversion	CR to `
Interface: RS232-OPOS	
Baud Rate	115200 Baud
Transmission Label ID Code	Prefix
GS1-128 AIM ID	Disable
UPCA Label ID Character(s)	C
UPCE Label ID Character(s)	D
EAN 8 Label ID Character(s)	A
EAN 13 Label ID Character(s)	B
Code ISBN Label ID Character(s)	@
Code 39 Label ID Character(s)	V
Code 32 Label ID Character(s)	X
Interleaved 2of5 Label ID Character(s)	N
Code Standard 2/5 Label ID Character(s)	P
Codabar Label ID Character(s)	R
Code 11 Label ID Character(s)	b
Code 128 Label ID Character(s)	T
GS1-128 Label ID Character(s)	k
UPCA/P2 Label ID Character(s)	F
UPCA/P5 Label ID Character(s)	G
UPCA/GS1-128 Label ID Character(s)	Q
UPCE P2 Label ID Character(s)	H

Parameter	Default Exception
UPCE/P5 Label ID Character(s)	I
EAN8/P2 Label ID Character(s)	J
EAN8/P5 Label ID Character(s)	K
EAN8/GS1-128 Label ID Character(s)	*
EAN13/P2 Label ID Character(s)	L
EAN13/P5 Label ID Character(s)	M
EAN13/GS1-128 Label ID Character(s)	#
GS1 DataBar 14 (Omnidirectional) Label ID Character(s)	u
GS1 DataBar Expanded Label ID Character(s)	t
GS1 DataBar Limited Label ID Character(s)	v



Appendix C

Sample Bar Codes

The sample bar codes in this appendix are typical representations for their symbology types.

1D Bar Codes

UPC-A



EAN-13



Code 39



Code 128



Interleaved 2 of 5



Code 32



Codabar

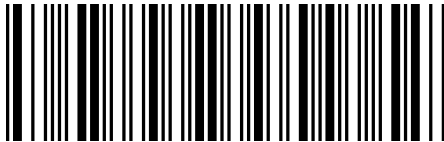

Code 93

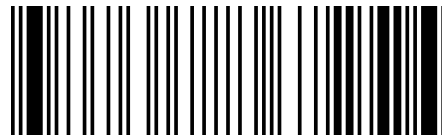

Code 11



GS1 DataBar (RSS)



NOTE

GS1 DataBar variants must be enabled to read the bar codes below (see "GS1 DataBar (RSS)" on page 273).



10293847560192837465019283746029478450366523
(GS1 DataBar Expanded Stacked)



1234890hji09900mnb
(GS1 DataBar Expanded)



08672345650916
(GS1 DataBar Limited)

GS1 DataBar-14



55432198673467
(GS1 DataBar Omnidirectional Truncated)



90876523412674
(GS1 DataBar Omnidirectional Stacked)







78123465709811
(GS1 DataBar Omnidirectional Stacked)

NOTES



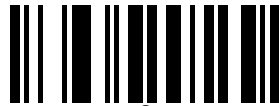

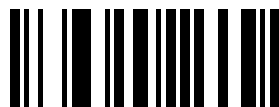



Appendix D Keypad

Use the bar codes in this appendix to enter numbers as you would select digits/
characters from a keypad.

 0	
	 1
 2	
	 3
 4	

Keypad (continued)

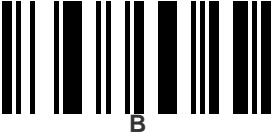
	 5
 6	
	 7
 8	
	 9
 A	
	 B

Keypad (continued)

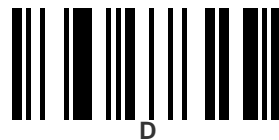
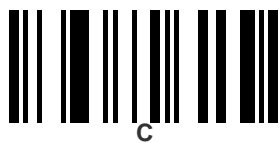

NOTES



Appendix E

Scancode Tables

Control Character Emulation

Control character emulation selects from different scancode tables as listed in this appendix. Each of the control character sets below are detailed by interface type in the tables. These apply to Wedge and USB Keyboard platforms.

Control Character 00: Characters from 00 to 0x1F are sent as control character Ctrl+Keys, special keys are located from 0x80 to 0xA1.

Control Character 01: Characters from 00 to 0x1F are sent as control character Ctrl+Capital Key, special keys are located from 0x80 to 0xA1.

Control Character 02: Special keys are located from 00 to 0x1F and characters from 0x80 to 0xFE are intended as an extended ASCII table (Microsoft Windows Codepage 1252 — see [page 284](#)).

Single Press and Release Keys

In the following tables, Ar↓ means Alt right pressed and Ar↑ means Alt right released and so on. Definitions for other keys are Al (Alt left), Cr (Control Right) Cl (Control Left) Sh (shift). This method can be used for combining Alt, Control or Shift with other keys.

Example: Consider a Control character set to 00. If AltRight+A is required before sending a label to the host, it could be done by setting three Prefix keys in this way: 0x99 0x41 0x9A.

Interface Type PC AT PS/2 or USB-Keybaord

Table 28. Scancode Set When Control Character is 00 or 01

	x0	x1	x2	x3	x4	x5	X6	x7	x8	x9	xA	xB	xC	xD	xE	xF
0x	NULL C+@	SOH C(S)+A	STX C(S)+B	ETX C(S)+C	EOT C(S)+D	ENQ C(S)+E	ACK C(S)+F	BEL C(S)+G	BS	HT TAB	LF C(S)+J	VT C(S)+K	FF C(S)+L	CR Enter	SO C(S)+N	SI C(S)+O
1x	DLE C(S)+P	DC1 C(S)+Q	DC2 C(S)+R	DC3 C(S)+S	DC4 C(S)+T	NAK C(S)+U	SYN C(S)+V	ETB C(S)+W	CAN C(S)+X	EM C(S)+Y	SUB C(S)+Z	ESC Esc	FS C+\ C+]	GS C+]	RS C+^	US C(S)+_
2x	SP	!	"	#	\$	%	&	'	()	*	+	,	-	.	/
3x	0	1	2	3	4	5	6	7	8	9	:	;	<	=	>	?
4x	@	A	B	C	D	E	F	G	H	I	J	K	L	M	N	O
5x	P	Q	R	S	T	U	V	W	X	Y	Z	[\]	^	_
6x	`	a	b	c	d	e	f	g	h	i	j	k	l	m	n	o
7x	p	q	r	s	t	u	v	w	x	y	z	{		}	~	Del
8x	€	Sh↓	Sh↑	Ins	Ent (keyp)	F1	F2	F3	F4	F5	F6	F7	F8	F9	F10	F11
9x	F12	Home	End	Pg Up	Pg Dwn	↑	↓	←	→	Ar↓	Ar↑	Al↓	Al↑	Cl↓	Cl↑	Cr↓
Ax	Cr↑		‘	f	„	...	†	‡	^	‰	Š	<	Ś	<	Œ	
Bx	°	±	²	³	´	µ	¶	·	¸	¹	º	»	¼	½	¾	¿
Cx	À	Á	Â	Ã	Ä	Å	Æ	Ç	È	É	Ê	Ë	Ì	Í	Î	Ï
Dx	Ð		Ò	Ó	Ô	Õ	Ö	×	Ø	Ù	Ú	Û	Ü	Ý	Þ	ß
Ex	à	á	â	ã	ä	å	æ	ç	è	é	ê	ë	ì	í	î	ï
Fx	ð	ñ	ò	ó	ô	õ	ö	÷	ø	ù	ú	û	ü	ý	þ	ÿ

Extended characters (sky blue) are sent through dedicated keys (when available in the selected country mode) or by using an Alt Mode sequence.

Interface Type PC AT PS/2 or USB-Keybaord (continued)

Table 29. Scancode Set When Control Character is 02

	x0	x1	x2	x3	x4	x5	X6	x7	x8	x9	xA	xB	xC	xD	xE	xF
0x	Ar↓	Ar↑	Al↓	Al↑	Cl↓	Cl↑	Cr↓	Cr↑	BS	Tab	→	S+ Tab	Enter Keyprd	Enter	Ins	Pg Up
1x	Pg Dwn	Home	←	↓	↑	F6	F1	F2	F3	F4	F5	ESC	F7	F8	F9	F10
2x	Space	!	“	#	\$	%	&	‘	()	*	+	,	-	.	/
3x	0	1	2	3	4	5	6	7	8	9	:	;	<	=	>	?
4x	@	A	B	C	D	E	F	G	H	I	J	K	L	M	N	O
5x	P	Q	R	S	T	U	V	W	X	Y	Z	[\]	^	_
6x	`	a	b	c	d	e	f	g	h	i	j	k	l	m	n	o
7x	p	q	r	s	t	u	v	w	x	y	z	{		}	~	Del
8x	€		‘	f	„	…	†	‡	^	‰	Š	<	Ś	<	Œ	
9x		‘	’	“	”	•	–	—	~	™	š	>	œ		ž	ÿ
Ax	NBSP	ı	¢	£	¤	¥	¦	§	¨	©	ª	«	¬	-	®	-
Bx	°	±	²	³	´	µ	¶	·	¸	¹	º	»	¼	½	¾	¿
Cx	À	Á	Â	Ã	Ä	Å	Æ	Ç	È	É	Ê	Ë	Ì	Í	Î	Ï
Dx	Ð		Ò	Ó	Ô	Õ	Ö	×	Ø	Ù	Ú	Û	Ü	Ý	Þ	ß
Ex	à	á	â	ã	ä	å	æ	ç	è	é	ê	ë	ì	í	î	ï
Fx	ð	ñ	ò	ó	ô	õ	ö	÷	ø	ù	ú	û	ü	ý	þ	ÿ

Interface Type PC AT PS/2 Alt Mode or USB-Keyboard Alt Mode

Table 30. Scancode Set When Control Character is 00 or 01

	x0	x1	x2	x3	x4	x5	x6	x7	x8	x9	xA	xB	xC	xD	xE	Xf
0x	Alt+000	Alt+001	Alt+002	Alt+003	Alt+004	Alt+005	Alt+006	Alt+007	BS	HT TAB	Alt+010	Alt+011	Alt+012	CR Enter	Alt+014	Alt+015
1x	Alt+016	Alt+017	Alt+018	Alt+019	Alt+020	Alt+021	Alt+022	Alt+023	Alt+024	Alt+025	Alt+026	ESC Esc	Alt+028	Alt+029	Alt+030	Alt+031
2x	A+032	A+033	A+034	A+035	A+036	A+037	A+038	A+039	A+040	A+041	A+042	A+043	A+044	A+045	A+046	A+047
3x	A+048	A+049	A+050	A+051	A+052	A+053	A+054	A+055	A+056	A+057	A+058	A+059	A+060	A+061	A+062	A+063
4x	A+064	A+065	A+066	A+067	A+068	A+069	A+070	A+071	A+072	A+073	A+074	A+075	A+076	A+077	A+078	A+079
5x	A+080	A+081	A+082	A+083	A+084	A+085	A+086	A+087	A+088	A+089	A+090	A+091	A+092	A+093	A+094	A+095
6x	A+096	A+097	A+098	A+099	A+100	A+101	A+102	A+103	A+104	A+105	A+106	A+107	A+108	A+109	A+110	A+111
7x	A+112	A+113	A+114	A+115	A+116	A+117	A+118	A+119	A+120	A+121	A+122	A+123	A+124	A+125	A+126	A+127
8x	€	Sh↓	Sh↑	Ins	Ent (keyp)	F1	F2	F3	F4	F5	F6	F7	F8	F9	F10	F11
9x	F12	Home	End	Pg Up	Pg Dwn	↑	↓	←	→	Ar↓	Ar↑	Al↓	Al↑	Cl↓	Cl↑	Cr↓
Ax	Cr↑	A+0161	A+0162	A+0163	A+0164	A+0165	A+0166	A+0167	A+0168	A+0169	A+0170	A+0171	A+0172	A+0173	A+0174	A+0175
Bx	A+0176	A+0177	A+0178	A+0179	A+0180	A+0181	A+0182	A+0183	A+0184	A+0185	A+0186	A+0187	A+0188	A+0189	A+0190	A+0191
Cx	A+0192	A+0193	A+0194	A+0195	A+0196	A+0197	A+0198	A+0199	A+0200	A+0201	A+0202	A+0203	A+0204	A+0205	A+0206	A+0207
Dx	A+0208	A+0209	A+0210	A+0211	A+0212	A+0213	A+0214	A+0215	A+0216	A+0217	A+0218	A+0219	A+0220	A+0221	A+0222	A+0223
Ex	A+0224	A+0225	A+0226	A+0227	A+0228	A+0229	A+0230	A+0231	A+0232	A+0233	A+0234	A+0235	A+0236	A+0237	A+0238	A+0239
Fx	A+0240	A+0241	A+0242	A+0243	A+0244	A+0245	A+0246	A+0247	A+0248	A+0249	A+0250	A+0251	A+0252	A+0253	A+0254	A+0255

Interface Type PC AT PS/2 Alt Mode or USB-Keyboard Alt Mode (continued)

Table 31. Scancode Set When Control Character is 02

	x0	x1	x2	x3	x4	x5	x6	x7	x8	x9	xA	xB	xC	xD	xE	xF
0x	Ar↓	Ar↑	Al↓	Al↑	Cl↓	Cl↑	Cr↓	Cr↑	BS	Tab	→	S+ Tab	Enter Keypd	Enter	Ins	Pg Up
1x	Pg Dwn	Home	←	↓	↑	F6	F1	F2	F3	F4	F5	ESC	F7	F8	F9	F10
2x	A+032	A+033	A+034	A+035	A+036	A+037	A+038	A+039	A+040	A+041	A+042	A+043	A+044	A+045	A+046	A+047
3x	A+048	A+049	A+050	A+051	A+052	A+053	A+054	A+055	A+056	A+057	A+058	A+059	A+060	A+061	A+062	A+063
4x	A+064	A+065	A+066	A+067	A+068	A+069	A+070	A+071	A+072	A+073	A+074	A+075	A+076	A+077	A+078	A+079
5x	A+080	A+081	A+082	A+083	A+084	A+085	A+086	A+087	A+088	A+089	A+090	A+091	A+092	A+093	A+094	A+095
6x	A+096	A+097	A+098	A+099	A+100	A+101	A+102	A+103	A+104	A+105	A+106	A+107	A+108	A+109	A+110	A+111
7x	A+112	A+113	A+114	A+115	A+116	A+117	A+118	A+119	A+120	A+121	A+122	A+123	A+124	A+125	A+126	A+127
8x	A+0128	A+0129	A+0130	A+0131	A+0132	A+0133	A+0134	A+0135	A+0136	A+0137	A+0138	A+0139	A+0140	A+0141	A+0142	A+0143
9x	A+0144	A+0145	A+0146	A+0147	A+0148	A+0149	A+0150	A+0151	A+0152	A+0153	A+0154	A+0155	A+0156	A+0157	A+0158	A+0159
Ax	A+0160	A+0161	A+0162	A+0163	A+0164	A+0165	A+0166	A+0167	A+0168	A+0169	A+0170	A+0171	A+0172	A+0173	A+0174	A+0175
Bx	A+0176	A+0177	A+0178	A+0179	A+0180	A+0181	A+0182	A+0183	A+0184	A+0185	A+0186	A+0187	A+0188	A+0189	A+0190	A+0191
Cx	A+0192	A+0193	A+0194	A+0195	A+0196	A+0197	A+0198	A+0199	A+0200	A+0201	A+0202	A+0203	A+0204	A+0205	A+0206	A+0207
Dx	A+0208	A+0209	A+0210	A+0211	A+0212	A+0213	A+0214	A+0215	A+0216	A+0217	A+0218	A+0219	A+0220	A+0221	A+0222	A+0223
Ex	A+0224	A+0225	A+0226	A+0227	A+0228	A+0229	A+0230	A+0231	A+0232	A+0233	A+0234	A+0235	A+0236	A+0237	A+0238	A+0239
Fx	A+0240	A+0241	A+0242	A+0243	A+0244	A+0245	A+0246	A+0247	A+0248	A+0249	A+0250	A+0251	A+0252	A+0253	A+0254	A+0255

Microsoft Windows Codepage 1252

Windows-1252 is a character encoding of the Latin alphabet, used by default in the legacy components of Microsoft Windows in English and some other Western languages.

	00	01	02	03	04	05	06	07	08	09	0A	0B	0C	0D	0E	0F
00	NUL 0000	STX 0001	SOT 0002	ETX 0003	EOT 0004	ENQ 0005	ACK 0006	BEL 0007	BS 0008	HT 0009	LF 000A	VT 000B	FF 000C	CR 000D	SO 000E	SI 000F
10	DLE 0010	DC1 0011	DC2 0012	DC3 0013	DC4 0014	NAK 0015	SYN 0016	ETB 0017	CAN 0018	EM 0019	SUB 001A	ESC 001B	FS 001C	GS 001D	RS 001E	US 001F
20	SP 0020	! 0021	" 0022	# 0023	\$ 0024	% 0025	& 0026	' 0027	(0028) 0029	* 002A	+ 002B	, 002C	- 002D	. 002E	/ 002F
30	0 0030	1 0031	2 0032	3 0033	4 0034	5 0035	6 0036	7 0037	8 0038	9 0039	: 003A	; 003B	< 003C	= 003D	> 003E	? 003F
40	@ 0040	A 0041	B 0042	C 0043	D 0044	E 0045	F 0046	G 0047	H 0048	I 0049	J 004A	K 004B	L 004C	M 004D	N 004E	O 004F
50	P 0050	Q 0051	R 0052	S 0053	T 0054	U 0055	V 0056	W 0057	X 0058	Y 0059	Z 005A	[005B	\ 005C] 005D	^ 005E	_ 005F
60	` 0060	a 0061	b 0062	c 0063	d 0064	e 0065	f 0066	g 0067	h 0068	i 0069	j 006A	k 006B	l 006C	m 006D	n 006E	o 006F
70	p 0070	q 0071	r 0072	s 0073	t 0074	u 0075	v 0076	w 0077	x 0078	y 0079	z 007A	{ 007B	 007C	} 007D	~ 007E	DEL 007F
80	€ 20AC	• 20A2	ƒ 20A3	„ 20A6	… 20A8	† 20A9	‡ 20AA	ˆ 20AB	‰ 20AC	Š 20A1	‹ 20A4	Œ 20A5	• 20A7	ž 20A8	• 20A9	• 20AA
90	• 20A2	ˆ 20AB	‰ 20AC	Š 20A1	‹ 20A4	Œ 20A5	• 20A7	ž 20A8	• 20A9	• 20AA	• 20AB	• 20AC	• 20AD	• 20AE	• 20AF	• 20B0
A0	NESE 00A0	ı 00A1	ç 00A2	£ 00A3	¤ 00A4	¥ 00A5	¦ 00A6	§ 00A7	¨ 00A8	© 00A9	ª 00AA	« 00AB	¬ 00AC	­ 00AD	® 00AE	¯ 00AF
B0	° 00B0	± 00B1	² 00B2	³ 00B3	´ 00B4	µ 00B5	¶ 00B6	· 00B7	¸ 00B8	¹ 00B9	º 00BA	» 00BB	¼ 00BC	½ 00BD	¾ 00BE	¿ 00BF
C0	À 00C0	Á 00C1	Â 00C2	Ã 00C3	Ä 00C4	Å 00C5	Æ 00C6	Ç 00C7	È 00C8	É 00C9	Ê 00CA	Ë 00CB	Ì 00CC	Í 00CD	Î 00CE	Ï 00CF
D0	Ð 00D0	Ñ 00D1	Ò 00D2	Ó 00D3	Ô 00D4	Õ 00D5	Ö 00D6	× 00D7	Ø 00D8	Ù 00D9	Ú 00DA	Û 00DB	Ü 00DC	Ý 00DD	Þ 00DE	ß 00DF
E0	à 00E0	á 00E1	â 00E2	ã 00E3	ä 00E4	å 00E5	æ 00E6	ç 00E7	è 00E8	é 00E9	ê 00EA	ë 00EB	ì 00EC	í 00ED	î 00EE	ï 00EF
F0	ø 00F0	ù 00F1	ú 00F2	ó 00F3	ô 00F4	õ 00F5	ö 00F6	÷ 00F7	ø 00F8	ù 00F9	ú 00FA	û 00FB	ü 00FC	ý 00FD	þ 00FE	ÿ 00FF



Index

B

- bar codes
 - RS-232
 - baud rate 45
 - RS-232 parameters
 - parity 206, 207, 209, 211
- Beeper
 - Pitch, Good Read 73
 - Volume, Good Read 74
- Beeper, Good Read 65

C

- Cable Pinouts 254
- Clear to Send 24, 218
- Conversion, case 60
- Conversion, character 60, 236
- CTS 24, 218

D

- Defaults 257

E

- Error Codes 253
- Errors 253

G

- Good Read, Beeper 65
 - Pitch 73
 - Volume 74
- Good Read, Beeper – 65

- Good Read, Beeper Pitch – 73
- Good Read, Beeper Volume – 74

H

- Handheld Scanner 48

I

- Indications 251

K

- keyboard support 36
- KEYBOARD WEDGE (KBW) interface selection 13
- Keyboard Wedge Connection 6

N

- numbers lock key 39, 40

P

- Pitch – Good Read, Beeper 73
- Prefix/Suffix 50, 230
- Product Specifications 249
- Programming Barcodes 14

R

- Read, Beeper – Good 65
- Read, Beeper Pitch – Good 73
- Read, Beeper Volume – Good 74
- Request to Send 24, 218

RS-232 interface selection 12
RTS 24, 218

S

sample bar codes
 code 128 272
 code 39 271
 interleaved 2 of 5 272
Scancode Tables 279
select digits/characters 275
Serial Output 254
Standard Cable Pinouts 254
Suffix 50, 230
Symbologies 217
symbology types 271

T

Table Top Scanner 48

U

UPC 87
USB Connection 6
USB interface selection 12

V

Volume – Good Read, Beeper 74

X

XON/XOFF 24, 218

ASCII Chart

ASCII Char.	Hex No.	ASCII Char.	Hex No.	ASCII Char.	Hex No.	ASCII Char.	Hex No.
NUL	00	SP	20	@	40	'	60
SOH	01	!	21	A	41	a	61
STX	02	"	22	B	42	b	62
ETX	03	#	23	C	43	c	63
EOT	04	\$	24	D	44	d	64
ENQ	05	%	25	E	45	e	65
ACK	06	&	26	F	46	f	66
BEL	07	'	27	G	47	g	67
BS	08	(28	H	48	h	68
HT	09)	29	I	49	i	69
LF	0A	*	2A	J	4A	j	6A
VT	0B	+	2B	K	4B	k	6B
FF	0C	,	2C	L	4C	l	6C
CR	0D	-	2D	M	4D	m	6D
SO	0E	.	2E	N	4E	n	6E
SI	0F	/	2F	O	4F	o	6F
DLE	10	0	30	P	50	p	70
DC1	11	1	31	Q	51	q	71
DC2	12	2	32	R	52	r	72
DC3	13	3	33	S	53	s	73
DC4	14	4	34	T	54	t	74
NAK	15	5	35	U	55	u	75
SYN	16	6	36	V	56	v	76
ETB	17	7	37	W	57	w	77
CAN	18	8	38	X	58	x	78
EM	19	9	39	Y	59	y	79
SUB	1A	:	3A	Z	5A	z	7A
ESC	1B	;	3B	[5B	{	7B
FS	1C	<	3C	\	5C		7C
GS	1D	=	3D]	5D	}	7D
RS	1E	>	3E	^	5E	~	7E
US	1F	?	3F	_	5F	DEL	7F



www.datalogic.com

©2015 Datalogic ADC, Inc. All rights reserved.
Datalogic and the Datalogic logo are registered
trademarks of Datalogic S.p.A. in many countries,
including the U.S.A. and the E.U.

Datalogic ADC, Inc.

959 Terry Street | Eugene | OR 97402 | USA
Telephone: (1) 541-683-5700 | Fax: (1) 541-345-7140

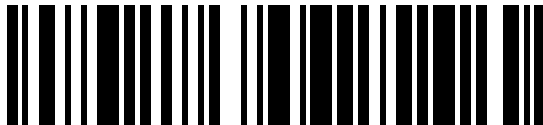

820065814

(Rev B)

February 2015