

Gryphon™ | GPS4400

On-Counter Presentation Scanner



Product Reference Guide

Datalogic ADC, Inc.

959 Terry Street
Eugene, OR 97402
USA

Telephone: (541) 683-5700

Fax: (541) 345-7140

©2013 Datalogic ADC, Inc.

An Unpublished Work - All rights reserved. No part of the contents of this documentation or the procedures described therein may be reproduced or transmitted in any form or by any means without prior written permission of Datalogic ADC, Inc. or its subsidiaries or affiliates ("Datalogic" or "Datalogic ADC"). Owners of Datalogic products are hereby granted a non-exclusive, revocable license to reproduce and transmit this documentation for the purchaser's own internal business purposes. Purchaser shall not remove or alter any proprietary notices, including copyright notices, contained in this documentation and shall ensure that all notices appear on any reproductions of the documentation.

Should future revisions of this manual be published, you can acquire printed versions by contacting your Datalogic representative. Electronic versions may either be downloadable from the Datalogic website (www.datalogic.com) or provided on appropriate media. If you visit our website and would like to make comments or suggestions about this or other Datalogic publications, please let us know via the "Contact Datalogic" page.

Disclaimer

Datalogic has taken reasonable measures to provide information in this manual that is complete and accurate, however, Datalogic reserves the right to change any specification at any time without prior notice.

Datalogic and the Datalogic logo are registered trademarks of Datalogic S.p.A. in many countries, including the U.S.A. and the E.U. All other brand and product names may be trademarks of their respective owners.

Patents

This product may be covered by one or more of the following patents:

Utility patents: EP0996284B1, EP0999514B1, EP1128315B1, EP1172756B1, EP1396811B1, EP1413971B1, EP1828957B1, JP4435343B2, US5481098, US6478224, US6512218, US6513714, US6561427, US6808114, US6877664, US6997385, US7053954, US7234641, US7387246, US7721966, US8245926.

Additional patents pending.



Table of Contents

INTRODUCTION	1
About this Manual	1
Overview	1
Manual Conventions	2
References	2
Technical Support	2
Datalogic Website Support	2
Reseller Technical Support	2
Telephone Technical Support	2
About the Reader	3
Programming the Reader	4
Configuration Methods	4
SETUP	5
Unpacking	5
Setting Up the Reader	5
Attaching Reader to Host	6
Attaching/Detaching the Stand	7
Interface Selection	8
Custom Configuration Settings	10
Configure Interface Settings	10
Global Interface Features	10
Configuring Other Features	10
Software Version Transmission	10
Resetting the Product Configuration to Defaults	11
CONFIGURATION USING BAR CODES	13
Configuration Parameters	13
GLOBAL INTERFACE FEATURES	15
Host Commands — Obey/Ignore	15
RS-232 Only Interface	17
Baud Rate	18
Data Bits	19
Stop Bits	19
Parity	20
Handshaking Control	21
RS-232/USB-Com Interfaces	22
Intercharacter Delay	23
Beep On ASCII BEL	23
Beep On Not on File	24
ACK NAK Options	24
ACK Character	25
NAK Character	25
ACK NAK Timeout Value	26
ACK NAK Retry Count	26
ACK NAK Error Handling	27
Indicate Transmission Failure	27
Disable Character	28
Enable Character	28
USB Keyboard Settings	29
Country Mode	30
Send Control Characters	34
Intercode Delay	35

USB Keyboard Speed	36
USB Keyboard Numeric Keypad	37
USB-OEM Interface	39
USB-OEM Device Usage	40
Transmit Labels in Code 39 Format	41
Interface Options	41
Data Format	43
Global Prefix/Suffix	44
Global AIM ID	45
Set AIM ID Individually for GS1-128	47
Label ID	48
Label ID: Pre-Loaded Sets	48
Individually Set Label ID	49
Label ID Control	49
Label ID Symbology Selection – 1D Symbologies	50
No Read Message	55
No Read String	55
CODE VERIFIER	56
Code Verifier Mode	56
Match String	57
Wrong Code String	57
Label Transmit Mode	58
Advanced Formatting: User Label Edit	58
Case Conversion	59
Character Conversion	59
Reading Parameters	61
Double Read Timeout	62
LED AND BEEPER INDICATORS	63
Power On Alert	63
Good Read: When to Indicate	63
Good Read Beep Type	64
Good Read Beep Frequency	64
Good Read Beep Length	65
Good Read Beep Volume	66
Good Read LED Duration	67
SCANNING FEATURES	68
Operating Mode	68
Phase Off Event	69
Phase Off Timeout	69
Serial Start Character	70
Serial Stop Character	70
Manual Trigger Control	71
Central Code Only	71
Scanning Active Time	72
Presentation Illumination Control	72
Aiming Pointer	73
Aiming Duration Timer	73
Green Spot Duration	74
Mobile Phone Mode	74
Mobile Bias	75
Partial Label Reading Control	75
Decode Negative Image	76
Image Capture	76
MULTIPLE LABEL READING	77
Multiple Labels per Frame	77
Multiple Labels Ordering by Code Symbology	78
Multiple Labels Ordering by Code Length	78
1D Symbologies	79
1D Code Selection	79
DISABLE ALL SYMBOLOGIES	80
CODE EAN/UPC	81
Coupon Control	81

UPC-A	82
UPC-A Enable/Disable	82
UPC-A Check Character Transmission	82
Expand UPC-A to EAN-13	83
UPC-A Number System Character Transmission	83
UPC-A 2D Component	84
UPC-E	84
UPC-E Enable/Disable	84
UPC-E Check Character Transmission	85
UPC-E 2D Component	85
Expand UPC-E to EAN-13	86
Expand UPC-E to UPC-A	86
UPC-E Number System Character Transmission	87
GTIN FORMATTING	87
EAN 13 (JAN 13)	88
EAN 13 Enable/Disable	88
EAN 13 Check Character Transmission	88
EAN-13 Flag 1 Character	89
EAN-13 ISBN Conversion	89
EAN-13 2D Component	90
ISSN	90
ISSN Enable/Disable	90
EAN 8 (JAN 8)	91
EAN 8 Enable/Disable	91
EAN 8 Check Character Transmission	91
Expand EAN 8 to EAN 13	92
EAN 8 2D Component	92
UPC/EAN GLOBAL SETTINGS	93
UPC/EAN Price Weight Check	93
UPC/EAN Quiet Zones	94
ADD-ONS	95
Optional Add-ons	95
Optional Add-On Timer	96
Optional GS1-128 Add-On Timer	99
CODE 39	102
Code 39 Enable/Disable	102
Code 39 Check Character Calculation	102
Code 39 Check Character Transmission	103
Code 39 Start/Stop Character Transmission	104
Code 39 Full ASCII	104
Code 39 Quiet Zones	105
Code 39 Length Control	105
Code 39 Set Length 1	106
Code 39 Set Length 2	107
TRIOPTIC CODE	108
Trioptic Code Enable/Disable	108
CODE 32 (ITAL PHARMACEUTICAL CODE)	108
Code 32 Enable/Disable	108
Code 32 Feature Setting Exceptions	109
Code 32 Check Char Transmission	109
Code 32 Start/Stop Character Transmission	109
CODE 39 CIP (FRENCH PHARMACEUTICAL)	110
Code 39 CIP Enable/Disable	110
CODE 39 DANISH PPT	110
Code 39 Danish PPT Enable/Disable	110
CODE 39 LAPOSTE	111
Code 39 LaPoste Enable/Disable	111
CODE 39 PZN	111
Code 39 PZN Enable/Disable	111
CODE 128	112
Code 128 Enable/Disable	112
Expand Code 128 to Code 39	112

Code 128 Check Character Transmission	113
Code 128 Function Character Transmission	113
Code 128 Sub-Code Exchange Transmission	114
Code 128 Quiet Zones	114
Code 128 Length Control	115
Code 128 Set Length 1	116
Code 128 Set Length 2	117
GS1-128	118
GS1-128 Enable	118
GS1-128 2D Component	118
CODE ISBT 128	119
ISBT 128 Concatenation	119
ISBT 128 Force Concatenation	119
ISBT 128 Concatenation Mode	120
ISBT 128 Dynamic Concatenation Timeout	121
ISBT 128 Advanced Concatenation Options	121
INTERLEAVED 2 OF 5 (I 2 OF 5)	122
I 2 of 5 Enable/Disable	122
I 2 of 5 Check Character Calculation	123
I 2 of 5 Check Character Transmission	124
I 2 of 5 Length Control	124
I 2 of 5 Set Length 1	125
I 2 of 5 Set Length 2	126
INTERLEAVED 2 OF 5 CIP HR	127
Interleaved 2 of 5 CIP HR Enable/Disable	127
FOLLETT 2 OF 5	127
Follett 2 of 5 Enable/Disable	127
STANDARD 2 OF 5	128
Standard 2 of 5 Enable/Disable	128
Standard 2 of 5 Check Character Calculation	128
Standard 2 of 5 Check Character Transmission	129
Standard 2 of 5 Length Control	129
Standard 2 of 5 Set Length 1	130
Standard 2 of 5 Set Length 2	131
INDUSTRIAL 2 OF 5	132
Industrial 2 of 5 Enable/Disable	132
Industrial 2 of 5 Check Character Calculation	132
Industrial 2 of 5 Check Character Transmission	133
Industrial 2 of 5 Length Control	133
Industrial 2 of 5 Set Length 1	134
Industrial 2 of 5 Set Length 2	135
CODE IATA	136
IATA Enable/Disable	136
IATA Check Character Transmission	136
CODABAR	137
Codabar Enable/Disable	137
Codabar Check Character Calculation	137
Codabar Check Character Transmission	138
Codabar Start/Stop Character Transmission	138
Codabar Start/Stop Character Set	139
Codabar Start/Stop Character Match	139
Codabar Quiet Zones	140
Codabar Length Control	140
Codabar Set Length 1	141
Codabar Set Length 2	142
ABC CODABAR	143
ABC Codabar Enable/Disable	143
ABC Codabar Concatenation Mode	143
ABC Codabar Dynamic Concatenation Timeout	144
ABC Codabar Force Concatenation	145
CODE 11	146
Code 11 Enable/Disable	146

Code 11 Check Character Calculation	146
Code 11 Check Character Transmission	147
Code 11 Length Control	147
Code 11 Set Length 1	148
Code 11 Set Length 2	149
GS1 DATABAR™ OMNIDIRECTIONAL	150
GS1 DataBar™ Omnidirectional Enable/Disable	150
GS1 DataBar™ Omnidirectional GS1-128 Emulation	150
GS1 DataBar™ Omnidirectional 2D Component	151
GS1 DATABAR™ EXPANDED	151
GS1 DataBar™ Expanded Enable/Disable	151
GS1 DataBar™ Expanded GS1-128 Emulation	152
GS1 DataBar™ Expanded 2D Component	152
GS1 DataBar™ Expanded Length Control	153
GS1 DataBar™ Expanded Set Length 1	154
GS1 DataBar™ Expanded Set Length 2	155
GS1 DATABAR™ LIMITED	156
GS1 DataBar™ Limited Enable/Disable	156
GS1 DataBar™ Limited GS1-128 Emulation	156
GS1 DataBar™ Limited 2D Component	157
CODE 93	157
Code 93 Enable/Disable	157
Code 93 Check Character Calculation	158
Code 93 Check Character Transmission	158
Code 93 Length Control	159
Code 93 Set Length 1	160
Code 93 Set Length 2	161
Code 93 Quiet Zones	162
MSI	162
MSI Enable/Disable	162
MSI Check Character Calculation	163
MSI Check Character Transmission	163
MSI Length Control	164
MSI Set Length 1	165
MSI Set Length 2	166
PLESSEY	167
Plessey Enable/Disable	167
Plessey Check Character Calculation	167
Plessey Check Character Transmission	168
Plessey Length Control	168
Plessey Set Length 1	169
Plessey Set Length 2	170
2D Symbolologies	171
2D Global Features	171
2D Maximum Decoding Time	172
2D Structured Append	173
2D Normal/Inverse Symbol Control	174
AZTEC CODE	175
Aztec Code Enable / Disable	175
Aztec Code Length Control	175
Aztec Code Set Length 1	176
Aztec Code Set Length 2	177
CHINA SENSIBLE CODE	178
China Sensible Code Enable / Disable	178
China Sensible Code Length Control	178
China Sensible Code Set Length 1	179
China Sensible Code Set Length 2	180
DATA MATRIX	181
Data Matrix Enable / Disable	181
Data Matrix Square/Rectangular Style	181
Data Matrix Length Control	182
Data Matrix Set Length 1	182

Data Matrix Set Length 2	183
MAXICODE	184
Maxicode Enable / Disable	184
Maxicode Primary Message Transmission	184
Maxicode Length Control	185
Maxicode Set Length 1	185
Maxicode Set Length 2	186
PDF417	187
PDF417 Enable / Disable	187
PDF417 Length Control	187
PDF417 Set Length 1	188
PDF417 Set Length 2	189
MICRO PDF417	190
Micro PDF417 Enable / Disable	190
Micro PDF417 Code 128 GS1-128 Emulation	190
Micro PDF417 Length Control	191
Micro PDF417 Set Length 1	191
Micro PDF417 Set Length 2	192
QR CODE	193
QR Code Enable / Disable	193
QR Code Length Control	193
QR Code Set Length 1	194
QR Code Set Length 2	195
MICRO QR CODE	196
Micro QR Code Enable/Disable	196
Micro QR Code Length Control	196
Micro QR Code Set Length 1	197
Micro QR Code Set Length 2	198
UCC COMPOSITE	199
UCC Composite Enable / Disable	199
UCC Optional Composite Timer	200
POSTAL CODE SELECTION	201
Postnet BB Control	202
SOFTWARE CONFIGURATION STRINGS	203
Command Syntax	204
SERIAL CONFIGURATION STRINGS	206
2D CODES	227
REFERENCES	231
RS-232 Parameters	232
RS-232 Only	232
RS-232/USB COM Parameters	233
USB Intercode Delay	240
Symbologies	241
Set Length	241
Data Editing	243
Global Prefix/Suffix	244
Global AIM ID	245
Label ID	246
Character Conversion	251
Scanner Data Formatting Control	252
Reading Parameters	254
Double Read Timeout	254
Good Read LED Duration	255
Scanning Features	256
Operating Mode	256
Scanning Active Time	258
Aiming Duration Time	259
Multiple Labels Ordering by Code Symbology	260
TECHNICAL SPECIFICATIONS	263
LED and Beeper Indications	266
Indicators	266

- Error Codes 268
- Host Interface Connections 268
- GPS4400 Dimensions 269
- Imager Labeling 271
 - Aiming System 271
- STANDARD DEFAULTS..... 273**
- SAMPLE BAR CODES..... 285**
- KEYPAD 289**
- HOST CONFIGURATION RESERVED CHARACTERS..... 291**
- SCANCODE TABLES..... 293**
 - Control Character Emulation 293
 - Single Press and Release Keys 293
 - Interface Type PC AT PS/2, USB-Keyboard or USB-Keyboard for APPLE 294
 - Interface type PC AT PS/2 Alt Mode or USB-Keyboard Alt Mode 296
 - Digital Interface 298
 - IBM31xx 102-key 299
 - IBM XT 300
 - Microsoft Windows Codepage 1252 301
- SCREW MOUNTING TEMPLATE 303**

NOTES



Chapter 1

Introduction

About this Manual

This Product Reference Guide (PRG) is provided for users seeking advanced technical information, including connection, programming, maintenance and specifications. The Quick Reference Guide (QRG) and other publications associated with this product are downloadable free of charge from the website listed on the back cover of this manual.

Overview

[Chapter 1](#), (this chapter) presents information about manual conventions, and an overview of the reader, its features and operation.

[Chapter 2, Setup](#) presents information about unpacking, cable connection information and setting up the reader.

[Chapter 3, Configuration Using Bar Codes](#) provides instructions and bar code labels for customizing your reader. There are different sections for interface types, general features, data formatting, and symbology-specific features.

[Chapter 4, Software Configuration Strings](#) provides background information and detailed instructions for more complex programming items.

[Chapter 5, References](#) provides background information and detailed instructions for more complex programming items.

[Appendix A, Technical Specifications](#) lists physical and performance characteristics, as well as environmental and regulatory specifications. It also provides standard cable pinouts and LED/Beeper functions.

[Appendix B, Standard Defaults](#) references common factory default settings for reader features and options.

[Appendix C, Sample Bar Codes](#) offers sample bar codes for several common symbologies.

[Appendix D, Keypad](#) includes numeric bar codes to be scanned for certain parameter settings.

[Appendix E, Host Configuration Reserved Characters](#) provides a table of reserved characters.

[Appendix F, Scancode Tables](#) lists control character emulation information for USB Keyboard interfaces.

[Appendix G, Screw Mounting Template](#) provides a full-size template that can be copied or detached and used for mounting the base to a fixed surface.

Manual Conventions

The following conventions are used in this document:

The symbols listed below are used in this manual to notify the reader of key issues or procedures that must be observed when using the reader:



Notes contain information necessary for properly diagnosing, repairing and operating the reader.



The CAUTION symbol advises you of actions that could damage equipment or property.

CAUTION

References

Current versions of this Product Reference Guide (PRG), Quick Reference Guide (QRG), the Datalogic Aladdin™ Configuration application, and any other manuals, instruction sheets and utilities for this product can be downloaded from the website listed below. Alternatively, printed copies or product support CDs for most products can be purchased through your Datalogic reseller.

Technical Support

Datalogic Website Support

The Datalogic website (www.datalogic.com) is the complete source for technical support and information for Datalogic products. The site offers product support, warranty information, product manuals, product tech notes, software updates, demos, and instructions for returning products for repair.

Reseller Technical Support

An excellent source for technical assistance and information is an authorized Datalogic reseller. A reseller is acquainted with specific types of businesses, application software, and computer systems and can provide individualized assistance.

Telephone Technical Support

If you do not have internet or email access, you may contact Datalogic technical support at (541) 349-8283 or check the back cover of your manual for more contact information.

About the Reader

The Gryphon™ 4400 series represents a premium level in bar code data collection devices from Datalogic using advanced imaging technology. The GPS4400 countertop presentation scanner offers hands-free scanning of small, easily handled items and hand held scanning operation for bulkier items. The reader's compact size makes it the ideal solution for space-constrained environments.

With a precise reading area, it is perfect for hands-free or handheld scanning and helps reduce accidental misreads of items caused by stray laser scan lines – improving productivity and customer satisfaction.

Its aggressive imaging performance and intuitive operation reduces user training and speeds checkout for better customer service.

The GPS4400 2D bar code scanner module features outstanding near-field reading, a wide angle field-of-view, high motion tolerance, snappy reading, and also offers excellent performance when decoding poor or damaged bar codes. As with all Gryphon readers, the GPS4400 reader offers good-read visual confirmation with Datalogic's patented 'Green Spot' technology as well as supporting advanced features like image capture.

User comfort is maximized with the bar code scanner's steady, deep red illumination light. Easier on the eyes than competitive products with flicker illumination, the highly visible 4-Dot aimer defines a precise reading zone and reduces accidental reads. The aimer's center cross provides a locator for targeted scanning in a multiple bar code environment.

The GPS4400 omni-directional reading provides snappy decoding performance on all common 1D and 2D codes as well as postal, stacked and composite codes like PDF417.

For mobile marketing or ticketing applications, this imager also offers excellent performance when reading bar codes from mobile devices. The GPS4400, with area imaging technology, eliminates the need for separate equipment with signature capture and document scanning capabilities.

The GPS4400 supports several modes that can be used as a trigger. This module has the ability to automatically sense objects and trigger itself. A continuous scan mode captures data whenever a bar code passes into its field-of-view.

The reader can also be triggered remotely through software commands. The GPS4400 bar code scanner supports an RS-232 serial interface or a USB (USB-HID or USB COM) interface.

Programming the Reader

Configuration Methods

Programming Bar Codes

The reader is factory-configured with a standard set of default features. After scanning the interface bar code, you can select other options and customize your reader through use of the instructions and programming bar code labels available in the corresponding features section for your interface. Customizable settings for many features are found in "Configuration Parameters" starting on page 13.

Some programming labels, like "Restore Custom Defaults" on page 11, require only the scan of the single label to enact the change. Most, however, require the reader to be placed in Programming Mode prior to scanning them. Scan an ENTER/EXIT bar code once to enter Programming Mode. Once the reader is in Programming Mode, scan a number of parameter settings before scanning the ENTER/EXIT bar code a second time, which will then accept your changes, exit Programming Mode and return the reader to normal operation.



There are some exceptions to the typical programming sequence described above. Please read the description and setting instructions carefully when configuring each programmable feature.

Datalogic Aladdin™

Programming can alternatively be performed using the Datalogic Aladdin™ Configuration application. Aladdin™ is a multi-platform utility program providing a quick and user-friendly configuration method via the RS-232/USB-COM interface. It communicates to the device through a user-friendly graphical interface running on a PC. Selected configuration commands are sent to the reader over the selected communication interface using a serial or USB cable, or they can be printed as bar codes to be scanned.

Aladdin also provides the ability to perform a software upgrade for the connected device (see the Datalogic Aladdin™ Help On-Line for more details).

Aladdin is available for free download from the Datalogic website.

Software Configuration Strings

The reader can also be configured by using command strings. These strings can be sent via the RS232/USB-COM interface using a terminal emulator such as HyperTerminal.

Refer to "Software Configuration Strings" starting on page 203 for configuration procedures using Serial Strings sent by the Host.



Chapter 2 Setup

Unpacking

Check carefully to ensure the reader and any accessories ordered are present and undamaged. If any damage occurred during shipment, contact Datalogic Technical Support. Information is shown on [page 2](#).

KEEP THE PACKAGING. Should the unit ever require service, it should be returned in its original shipping container.

Setting Up the Reader

Follow the steps provided in this section to connect and get your reader up and communicating with its host.

1. Begin by connecting the scan module to the host. The correct Interface Selection will occur automatically.
2. If modifications are needed, go to [Interface Selection](#) and set the desired interface.
3. [Configure Interface Settings](#) (only if not using factory settings for that interface)
4. Go to [Configuring Other Features](#) (if modifications are needed from factory settings)

Attaching Reader to Host

RS-232 Serial Connection



Turn off power to the terminal/PC and connect the reader to the terminal/PC serial port via the RS-232 cable as shown in [Figure 1](#). If the terminal will not support POT (Power Off the Terminal) to supply reader power, use the approved power supply (AC Adapter). Plug the AC Adapter barrel connector into the socket on the RS-232 cable connector and the AC Adapter plug into a standard power outlet.

Figure 1. RS-232 Connection

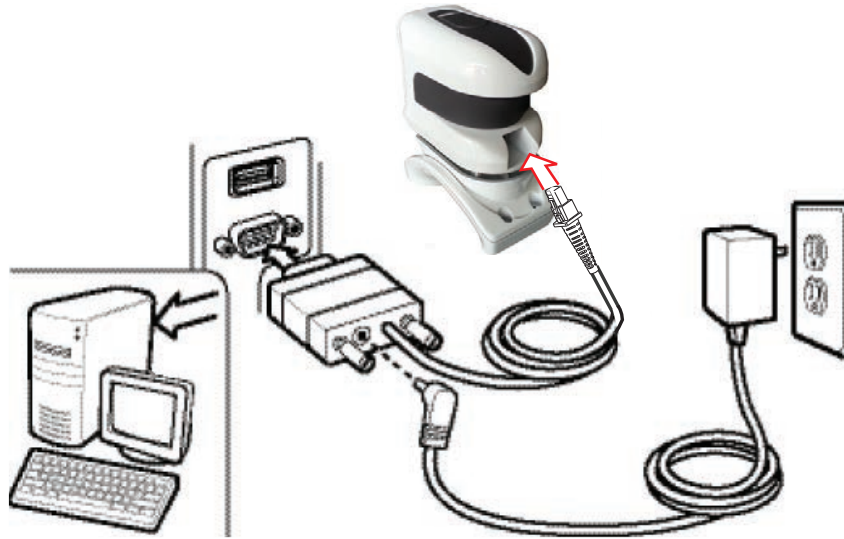

USB Connection



Connect the reader to a USB port on the terminal/PC. Reference [Figure 2](#).

Figure 2. USB connection

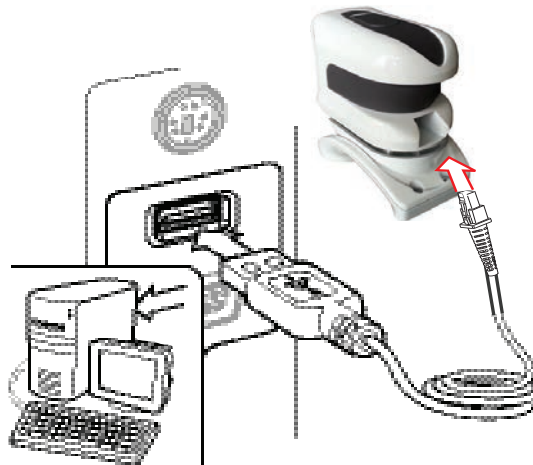

Attaching/Detaching the Stand

The reader can be removed or attached to the stand simply by snapping on or off. To attach, align the holes on the bottom of the scanner with the posts on the stand and push down to snap in place. To remove, just pull straight up to detach the reader from the stand.

For product dimensional information, see [Technical Specifications](#) on page 263 and [GPS4400 Dimensions](#) on page 269.

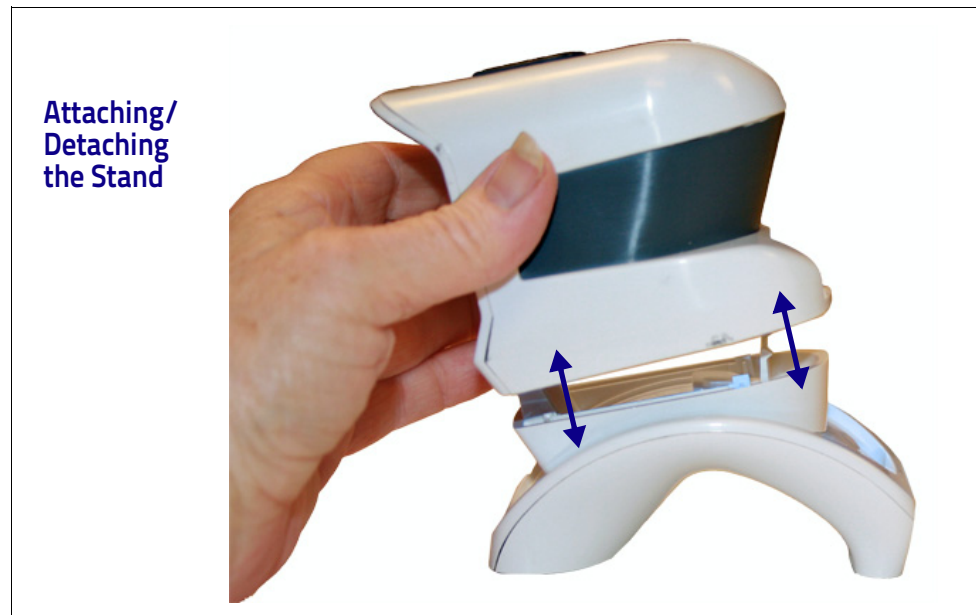

The stand can also be mounted to a stationary surface using two screws. See [Appendix G, Screw Mounting Template](#) for a full-scale template that shows screw placement.



Interface Selection

The reader has 'Auto Cable Detect' and will power up in the appropriate interface and type. Your scanner may have been shipped with the desired interface cable (RS-232 or USB) and the interface type may have been pre-defined. If you need to change the interface type (example: USB-COM or USB-KBD), go to [Table 1](#) below and scan the appropriate bar code in that section.

The reader will support the following sets of host interfaces:

- RS-232-STD
- RS-232 Wincor-Nixdorf
- USB-COM, USB-OEM, USB-KBD, USB_KBD-ALT, USB-KBD-Apple





If your installation requires you to select options to customize your reader, turn to the appropriate section for your interface type in "Configuration Using Bar Codes" starting on page 13 (also listed beside each interface type in [Table 1](#)).









Unlike some programming features and options, interface selections require that you scan only one programming bar code label. **DO NOT** scan an ENTER/EXIT bar code prior to scanning an interface selection bar code.

Some interfaces require the scanner to start in the disabled state when powered up. If additional scanner configuration is desired while in this state, pull the trigger and hold it for five seconds. The scanner will change to a state that allows programming with bar codes.

Table 1. Available Interfaces

RS-232		FEATURES
 RS-232 standard interface	 Select RS232-STD	Set RS-232 Interface Features starting on page 17
 Select RS232-WN	RS-232 Wincor-Nixdorf	
RS-232 for use with OPOS/UPOS/JavaPOS	 Select RS-232 OPOS	

USB		FEATURES
 Select USB Keyboard	 USB Keyboard with standard key encoding	Set USB Interface Features starting on page 29
USB Keyboard for Apple computers	 Select USB-KBD-APPLE	
 Select USB Alternate Keyboard	USB Keyboard with alternate key encoding	
USB Com to simulate RS-232 standard interface	 Select USB-COM-STD ^a	Set USB COM Features starting on page 22
USB-OEM		FEATURES
 Select USB-OEM	USB-OEM (can be used for OPOS/UPOS/JavaPOS)	Set USB-OEM Interface Features starting on page 39

a. Download the correct USB Com driver from www.datalogic.com

Custom Configuration Settings

Configure Interface Settings

If your installation requires you to select options to customize your reader, turn to the appropriate section for your interface type in "Configuration Using Bar Codes" starting on page 13.

- RS-232 Only Interface on page 17
- RS-232/USB-Com Interfaces on page 22
- USB Keyboard Settings on page 29

Global Interface Features

See "Global Interface Features" on page 15 for settings configurable by all interface types.

Configuring Other Features

If your installation requires different programming than the standard factory default settings, the following sections of this manual allow configuration of non-interface-specific settings you might require:

Reading Parameters: Reading Parameters include programming for scanning, beeper and LED indicators and other universal settings.

1D Symbologies: Includes options concerning the bar code label types (symbologies). These settings allow you to enable/disable symbologies, set label lengths, require check digit, etc.

2D Symbologies on page 171 provides configuration of a personalized mix of 2D codes, code families and their options.

Software Version Transmission

The software version of the device can be transmitted over the interface by scanning the following label.

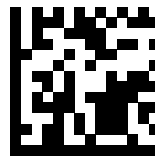

Transmit Software Version

Resetting the Product Configuration to Defaults

Restore Custom Defaults

If you aren't sure what programming options are in your imager, or you've changed some options and want to restore the Custom Default Configuration that may have been saved in the scanner, scan the Restore Custom Default Configuration bar code below. This will restore the custom configuration for the currently active interface.



Custom defaults are based on the interface type. Configure the imager for the correct interface before scanning this label.

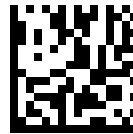

Restore Custom Default Configuration

Restore Factory Configuration

If you want to restore the Factory Configuration for your imager, scan either the Restore USA Factory Configuration bar code or the Restore EU Factory Configuration bar code below. Both labels restore the scanner configuration to the factory settings, including the interface type. The USA label restores Label IDs to those historically used in the USA. The EU label restores Label IDs to those historically used in Europe. The Label ID sets for USA and EU are shown in the [Label ID Control](#) on page 49 of this manual.

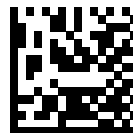

Restore USA Factory Configuration



Restore EU Factory Configuration

The programming items listed in the following sections show the factory default settings for each of the menu commands.

NOTES



Chapter 3

Configuration Using Bar Codes

This and following sections provide programming bar codes to configure your reader by changing the default settings. For details about additional methods of programming, see "Configuration Methods" on page 4.



You must first enable your reader to read bar codes in order to use this section. If you have not done this, go to [Setup](#), starting on page 5 and complete the appropriate procedure.

Configuration Parameters

Once the reader is set up, you can change the default parameters to meet your application needs. Refer to "Standard Defaults" starting on page 273 for initial configuration in order to set the default values and select the interface for your application.

The following configuration parameters are divided into logical groups, making it easy to find the desired function based on its reference group.

Interface Configuration:

- "Global Interface Features" on page 15
- "RS-232 Only Interface" on page 17
- "RS-232/USB-Com Interfaces" on page 22
- "USB Keyboard Settings" on page 29
- "USB-OEM Interface" on page 39

Parameters common to all interface applications:

- "Data Format" on page 43 gives options to control the messages sent to the Host system.
- "Reading Parameters" on page 61 control various operating modes and indicators status functioning.

Symbology-specific parameters:

- "1D Symbologies" on page 79 provides configuration of a personalized mix of 1D codes, code families and their options.
- "2D Symbologies" on page 171 provides configuration of a personalized mix of 2D codes, code families and their options.



You must first enable your reader to read bar codes in order to use this section. If you have not done this, go to [Setup](#), starting on page 5 and complete the appropriate procedure.

To program features:

1. Scan the ENTER/EXIT PROGRAMMING bar code, available at the top of each programming page, when applicable.
2. Scan the bar code to set the desired programming feature. You may need to cover unused bar codes on the page, and possibly the facing page, to ensure that the reader reads only the bar code you intend to scan.
3. If additional input parameters are needed, go to [Appendix D, Keypad](#), and scan the appropriate characters from the keypad.



Additional information about many features can be found in the "References" chapter.

If you make a mistake before the last character, scan the CANCEL bar code to abort and not save the entry string. You can then start again at the beginning.

4. Complete the programming sequence by scanning the ENTER/EXIT PROGRAMMING bar code to exit Programming Mode.

For more detailed descriptions, programming information and examples for setting selected configuration items, see [References](#), starting on page 231.

GLOBAL INTERFACE FEATURES

The following interface features are configurable by all interface types.

Host Commands — Obey/Ignore

This option specifies whether the reader will obey or ignore host commands. When set to ignore, the reader will ignore all host commands except those necessary for:

- service mode
- flash programming mode
- keeping the interface active
- transmission of labels.

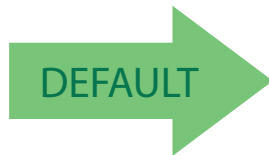

Host Commands = Obey
(Do Not Ignore Host Commands)



Host Commands = Ignore



NOTES

RS-232 ONLY INTERFACE

BAUD RATE on page 18
DATA BITS on page 19
STOP BITS on page 19
PARITY on page 20
HANDSHAKING CONTROL on page 21

Use the programming bar codes in this section if modifications to the standard RS-232 interface settings are necessary to meet your system's requirements. Additional settings which apply to both the RS-232 and USB interfaces are available in the next section, "[RS-232/USB-Com Interfaces](#)" starting on page 22.

Reference [Appendix B, Standard Defaults](#) for a listing of standard factory settings.



Baud Rate

See [page 232](#) for information on this feature.



Baud Rate = 1200



Baud Rate = 2400



Baud Rate = 4800



Baud Rate = 9600



Baud Rate = 19,200



Baud Rate = 38,400



Baud Rate = 57,600



Baud Rate = 115,200

Data Bits

This parameter allows the reader to interface with devices requiring a 7-bit or 8-bit ASCII protocol for sending and receiving data.



Stop Bits

Set the number of stop bits to match host device requirements. See [page 232](#) for more information on this feature.

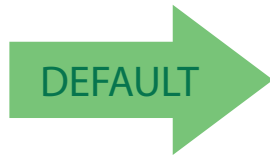



Parity

This feature specifies parity required for sending and receiving data. Select the parity type according to host device requirements. See [page 232](#) for more information.

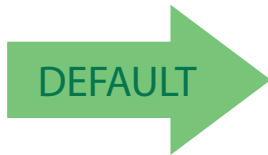

Parity = None



Parity = Even



Parity = Odd

Handshaking Control

See page 232 for more information about this feature.

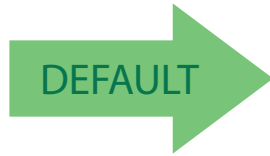

Handshaking Control = RTS



Handshaking Control = RTS/CTS



Handshaking Control = RTS/XON/XOFF



Handshaking Control = RTS On/CTS



Handshaking Control = RTS/CTS Scan Control

RS-232/USB-COM INTERFACES

INTERCHARACTER DELAY on page 23
BEEP ON ASCII BEL on page 23
BEEP ON NOT ON FILE on page 24
ACK NAK OPTIONS on page 24
ACK CHARACTER on page 25
NAK CHARACTER on page 25
ACK NAK TIMEOUT VALUE on page 26
ACK NAK RETRY COUNT on page 26
ACK NAK ERROR HANDLING on page 27
INDICATE TRANSMISSION FAILURE on page 27
DISABLE CHARACTER on page 28
ENABLE CHARACTER on page 28

The programming bar codes in this chapter allow modifications to the standard RS-232 and USB-Com interfaces. Reference [Appendix B, Standard Defaults](#) for a listing of standard factory settings.

Intercharacter Delay

This parameter specifies the intercharacter delay between the end of one character and the beginning of the next. The delay can be set within a range of zero (0) to 990 milliseconds in 10ms increments. A setting of zero specifies no delay.



Select Intercharacter Delay Setting



Intercharacter Delay = No Delay

To configure this feature, scan the ENTER/EXIT PROGRAMMING MODE bar code above, then the bar code at left followed by the digits from the Alphanumeric characters in [Appendix D, Keypad](#) representing your desired character(s). End by scanning the ENTER/EXIT bar code again.

Make a mistake? Scan the CANCEL bar code to abort and not save the entry string. You can then restart at the beginning.



CANCEL

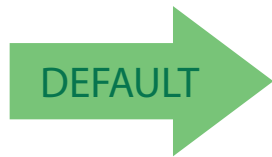

00 = No Intercharacter Delay

Beep On ASCII BEL

When this parameter is enabled, the reader issues a beep when a <BEL> character is detected on the RS-232 serial line. <BEL> is issued to gain a user's attention to an illegal entry or other important event.



Beep On ASCII BEL = Disable



DEFAULT



Beep On ASCII BEL = Enable



Beep On Not on File

This option enables/disables the action of the reader to sound a three beep sequence upon receiving a Not-On-File (NOF) host command.



Beep On Not On File = Disable

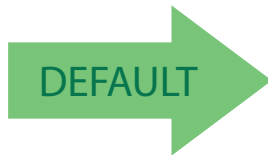

Beep On Not On File = Enable

ACK NAK Options

This enables/disables the ability of the reader to support the RS-232 ACK/NAK protocol.

See [page 234](#) for more information.



ACK/NAK Protocol = Disable ACK/NAK



ACK/NAK Protocol = Enable for label transmission



ACK/NAK Protocol = Enable for host-command acknowledge



ACK/NAK Protocol = Enable for label transmission and host-command acknowledge

ACK Character

This setting specifies an ASCII character or hex value to be used as the ACK character. ASCII characters or any hex value from 0 to 0xFF can be selected. See [page 234](#) for more information.



Setting to previously defined characters such as XON, XOFF, or host commands conflicts with normal operation of these characters. 8-bit data is not recognized when the option [Data Bits](#) has been set as 7 Data Bits.



Select ACK Character Setting

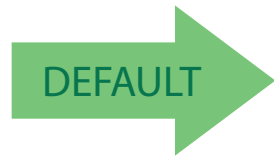

0x06 'ACK' Character

NAK Character

This setting specifies an ASCII character or hex value to be used as the NAK character. ASCII characters or any hex value from 0 to 0xFF can be selected. See [page 235](#) for more information.



Setting to previously defined characters such as XON, XOFF, or host commands conflicts with normal operation of these characters. 8-bit data is not recognized when the option [Data Bits](#) has been set as 7 Data Bits.



Select NAK Character Setting

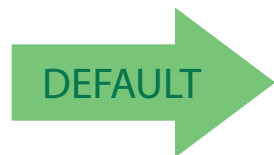

0x15 'NAK' Character



ACK NAK Timeout Value

This option specifies the amount of time the reader waits for an ACK character from the host following label transmission. The selectable timeout range is 200 milliseconds to 15,000ms (15 seconds) in 200ms increments. A selection of 0 disables the timeout. See [page 236](#) for more information.



Select ACK NAK Timeout Value Setting

To configure this feature, scan the ENTER/EXIT PROGRAMMING MODE bar code above, then the bar code at left followed by the digits from the Alphanumeric characters in [Appendix D, Keypad](#) representing your desired character(s). End by scanning the ENTER/EXIT bar code again.

Make a mistake? Scan the CANCEL bar code to abort and not save the entry string. You can then start again at the beginning.



CANCEL



ACK NAK Retry Count

Specifies the number of times the reader retries a label transmission due to a retry condition. The selectable range is from 1 to 254 retries. A selection of 0 disables the count, and a selection of 255 specifies unlimited retries. See [page 237](#) for more information.



Select ACK NAK Retry Count Setting

To configure this feature, scan the ENTER/EXIT PROGRAMMING MODE bar code above, then the bar code at left followed by the digits from the Alphanumeric characters in [Appendix D, Keypad](#) representing your desired character(s). End by scanning the ENTER/EXIT bar code again.

Make a mistake? Scan the CANCEL bar code to abort and not save the entry string. You can then start again at the beginning.



CANCEL



ACK NAK Error Handling

This feature specifies the method the reader uses to handle receive errors detected while waiting for an ACK character from the host.

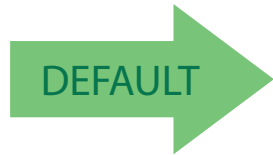

ACK NAK Error Handling = Ignore Errors Detected



ACK NAK Error Handling =
Process Error as Valid ACK Character



ACK NAK Error Handling = Process Error as
Valid NAK Character

Indicate Transmission Failure

This option enables/disables the reader's ability to sound an error beep to indicate a transmission failure while in ACK/NAK mode.



Indicate Transmission Failure = Disable Indication



Indicate Transmission Failure = Enable Indication





Disable Character

Specifies the value of the RS-232 host command used to disable the reader. ASCII characters or any hex value from 0 to 0xFF can be selected.



Setting to previously defined characters such as XON, XOFF, or host commands conflicts with normal operation of these characters. 8-bit data is not recognized when the option **Data Bits** has been set as 7 Data Bits.

See [page 238](#) for more information on setting this feature.



Select Disable Character Setting

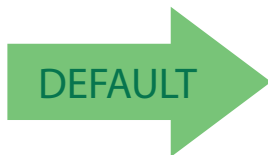

0x44 = Disable Character is 'D'

Enable Character

Specifies the value of the RS-232 host command used to enable the reader. ASCII characters or any hex value from 0 to 0xFF can be selected.



Setting to previously defined characters such as XON, XOFF, or host commands conflicts with normal operation of these characters. 8-bit data is not recognized when the option **Data Bits** has been set as 7 Data Bits.

See [page 239](#) in “References” for more information on setting this feature.



Select Enable Character Setting

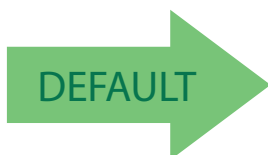

0x45 = Enable Character is 'E'

USB KEYBOARD SETTINGS

COUNTRY MODE on page 30
SEND CONTROL CHARACTERS on page 34
INTERCODE DELAY on page 35
USB KEYBOARD SPEED on page 36
USB KEYBOARD NUMERIC KEYPAD on page 37

Use the programming bar codes in this chapter to select options for USB Keyboard Interface. Reference [Appendix B, Standard Defaults](#) for a listing of standard factory settings.

Information about control character emulation which applies to keyboard interfaces is listed in [Appendix F, Scancode Tables](#).



Country Mode

This feature specifies the country/language supported by the keyboard. Several languages are supported:

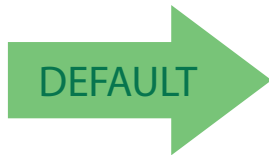

Country Mode = U.S.



Country Mode = Belgium



Country Mode = Britain

Supports only the interfaces listed in the Country Mode feature description.



Country Mode = Croatia

Supports only the interfaces listed in the Country Mode feature description.



Country Mode = Czech Republic

Supports only the interfaces listed in the Country Mode feature description.



Country Mode = Denmark



Country Mode (continued)



Country Mode = France

Supports only the interfaces listed in the Country Mode feature description.



Country Mode = French Canadian



Country Mode = Germany

Supports only the interfaces listed in the Country Mode feature description.



Country Mode = Hungary



Country Mode = Italy

Supports only the interfaces listed in the Country Mode feature description.



Country Mode = Japanese 106-key



Country Mode (continued)



Country Mode = Lithuanian

Supports only the interfaces listed in the Country Mode feature description.



Country Mode = Norway



Country Mode = Poland

Supports only the interfaces listed in the Country Mode feature description.

Supports only the interfaces listed in the Country Mode feature description.



Country Mode = Portugal



Country Mode = Romania

Supports only the interfaces listed in the Country Mode feature description.

Supports only the interfaces listed in the Country Mode feature description.



Country Mode = Slovakia



Country Mode (continued)



Country Mode = Spain



Country Mode = Sweden

Supports only the interfaces listed in the Country Mode feature description.



Country Mode = Switzerland



Send Control Characters

This feature specifies how the reader transmits ASCII control characters to the host. Reference [Appendix F, Scancode Tables](#) for more information about control characters.

Options are as follows:

Control Character 00 : Characters from 00 to 0x1F are sent as control character Ctrl+Keys, special keys are located from 0x80 to 0xA1.

Control Character 01 : Characters from 00 to 0x1F are sent as control character Ctrl+Shift, special keys are located from 0x80 to 0xA1.

Control Character 02 : Special keys are located from 00 to 0x1F and characters from 0x80 to 0xFE are intended as an extended ASCII table (see "[Microsoft Windows Codepage 1252](#)" on page 301).

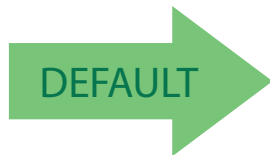

Reader Send Control Characters = 00



Reader Send Control Characters = 01



Reader Send Control Characters = 02

Intercode Delay

Specifies the delay between labels transmitted to the host for this interface. The selectable range for this feature is from 0 to 99 seconds.

See [page 240](#) in “References” for detailed information and examples for setting this feature.



Set Intercode Delay

To configure this feature, scan the ENTER/EXIT PROGRAMMING MODE bar code above, then the bar code at left followed by the digits from the Alphanumeric characters in [Appendix D, Keypad](#) representing your desired character(s). End by scanning the ENTER/EXIT bar code again.

Make a mistake? Scan the CANCEL bar code to abort and not save the entry string. You can then start again at the beginning.



CANCEL

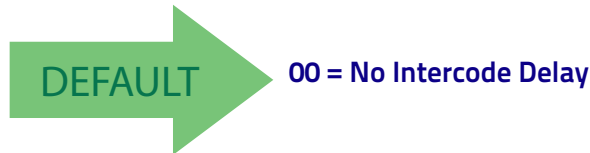



USB Keyboard Speed

This option specifies the USB poll rate for a USB keyboard.



This feature applies **ONLY** to the USB Keyboard interface.

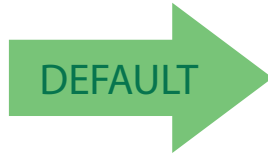

USB Keyboard Speed = 1ms



USB Keyboard Speed = 2ms



USB Keyboard Speed = 3ms



USB Keyboard Speed = 4ms



USB Keyboard Speed = 5ms



USB Keyboard Speed = 6ms

USB Keyboard Speed (continued)



USB Keyboard Speed = 7ms



USB Keyboard Speed = 8ms



USB Keyboard Speed = 9ms



USB Keyboard Speed = 10ms

USB Keyboard Numeric Keypad

This option Controls whether numeric characters will be sent using standard keys or the numeric keypad.

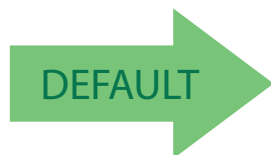

Standard Keys



Numeric Keypad



NOTES

USB-OEM INTERFACE

USB-OEM DEVICE USAGE on page 40
TRANSMIT LABELS IN CODE 39 FORMAT on page 41
INTERFACE OPTIONS on page 41

Feature settings for USB interfaces differ depending upon which host type the reader will be connected with. Use the feature settings in this chapter to specifically configure for the USB-OEM interface. Other USB interfaces are included in the appropriate chapter for their host type.

Reference [Appendix B on page 273](#) for a listing of standard factory settings.



USB-OEM Device Usage

The USB-OEM protocol allows for the reader to be identified as one of two different types of bar code scanners. Depending on what other scanners you may already have connected to a USB-OEM POS, you may need to change this setting to enable all devices to communicate.

Options are:

- Table Top Scanner
- Handheld Scanner



It may be necessary to switch device usage when connecting two readers/scanners of the same type to a POS system.



USB-OEM Device Usage = Table Top Scanner



USB-OEM Device Usage = Handheld Scanner



Transmit Labels in Code 39 Format

This feature enable/disables translation to Code 39 before transmitting label data to a USB-OEM host. Only the symbology identifier is modified for the translation. The data is not converted to Code 39 or verified to be valid for Code 39.

Options are:

Code 39 Format: Translate the following symbologies to Code 39:

- USB-OEM: Code128, Code 93, and Codabar

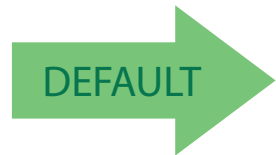

Transmit Labels in Code 39 Format =
IBM Standard Format



Transmit Labels in Code 39 Format = Code 39 Format

Interface Options

This feature provides for an interface-specific control mechanism.



Obey Scanner Configuration Host Commands



Ignore Scanner Configuration Host Commands



NOTES

DATA FORMAT

GLOBAL PREFIX/SUFFIX on page 44
GLOBAL AIM ID on page 45
SET AIM ID INDIVIDUALLY FOR GS1-128 on page 47
LABEL ID starting on page 48 <ul style="list-style-type: none">•Label ID: Pre-Loaded Sets•Individually Set Label ID•Label ID Control•Label ID Symbology Selection – 1D Symbologies•Label ID Symbology Selection – 2D Symbologies
NO READ MESSAGE starting on page 55
NO READ STRING starting on page 55
CODE VERIFIER MODE starting on page 56 <ul style="list-style-type: none">•Code Verifier Mode•Match String•Wrong Code String
CASE CONVERSION on page 59
CHARACTER CONVERSION on page 59

The features in this chapter can be used to build specific user-defined data into a message string. See “References” starting on [page 243](#) for more detailed instructions on setting these features.

Reference [Appendix B on page 273](#) for a listing of standard factory settings.



Global Prefix/Suffix

This option sets up to 20 characters each from the set of ASCII characters or any hex value from 00 to FF. The characters may be added as a prefix (in a position before the bar code data, also called a header) and/or as a suffix (in a position following the bar code data, also called a footer). See [page 244](#) for more detailed instructions on setting this feature.

To configure this feature, scan the ENTER/EXIT PROGRAMMING MODE bar code above to place the unit in Programming Mode, then the “Set Global Prefix” or “Set Global Suffix,” bar code followed by the digits (in hex) from the Alphanumeric characters in [Appendix D on page 289](#) representing your desired character(s). If less than the expected string of 20 characters are selected, scan the ENTER/EXIT bar code to terminate the string. Exit programming mode by scanning the ENTER/EXIT bar code again.



Set Global Prefix



Set Global Suffix

Make a mistake? Scan the CANCEL bar code to abort and not save the entry string. You can then start again at the beginning.



CANCEL

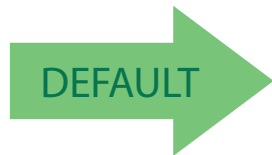

No Global Prefix
Global Suffix = 0x0D (CR)

Global AIM ID



This feature enables/disables addition of AIM IDs for all symbology types.

AIM label identifiers (as opposed to custom characters you select yourself as with label identifiers) can be included with scanned bar code data. See Table 2 on page 3-45 for a listing of AIM IDs.

AIM label identifiers consist of three characters as follows:

- A close brace character (ASCII ']'), followed by...
- A code character (see some samples in the table below), followed by...
- A modifier character (the modifier character is symbol dependent).

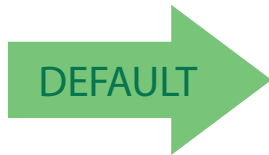

Global AIM ID = Disable



Global AIM ID = Enable

Table 2. AIM IDs

Tag Name	AIM ID code character	AIM ID code ASCII value
ABC CODABAR	X	58
ANKER PLESSEY	N	4E
AZTEC	z	7A
CHINA SENSIBLE CODE	X	58
CODABAR	F	46
CODE11	H	48
CODE128	C	43
CODE32	A	41
CODE39	A	41
CODE39 CIP	X	58
CODE39 DANISH PPT	X	58
CODE39 LAPOSTE	X	58
CODE39 PZN	X	58
CODE93	G	47
DATABAR 14	e	65
DATABAR 14 COMPOSITE	e	65
DATABAR EXPANDED	e	65



DATABAR EXPANDED COMPOSITE	e	65
DATABAR LIMITED	e	65
DATABAR LIMITED COMPOSITE	e	65
DATA MATRIX	d	64
EAN128	C	43
EAN128 COMPOSITE	C	43
EAN13	E	45
EAN13 P2	E	45
EAN13 P5	E	45
EAN13 COMPOSITE	E	45
EAN8	E	45
EAN8 P2	E	45
EAN8 P5	E	45
EAN8 COMPOSITE	E	45
FOLLET 2OF5	X	58
I2OF5	I	49
IATA INDUSTRIAL 2OF5	X	58
INDUSTRIAL 2OF5	X	58
ISBN	X	58
ISBT128 CONCAT	X	58
ISSN	X	58
MAXICODE	U	55
MICRO QR	Q	51
MICRO PDF	L	4C
MSI	M	4D
PDF417	L	4C
PLESSEY	P	50
POSTAL AUSTRALIAN	X	58
POSTAL IMB	X	58
POSTAL JAPANESE	X	58
POSTAL KIX	X	58
POSTAL PLANET	X	58
POSTAL PORTUGAL	X	58
POSTAL POSTNET BB	X	58
POSTAL ROYAL MAIL	X	58
POSTAL SWEDISH	X	58
POSTNET	X	58
QR CODE	Q	51
S25	S	53
TRIOPTIC	X	58
UPCA	E	45
UPCA P2	E	45
UPCA P5	E	45
UPCA COMPOSITE	E	45
UPCE	E	45
UPCE P2	E	45
UPCE P5	E	45
UPCE COMPOSITE	E	45



Set AIM ID Individually for GS1-128

This feature configures a Label ID individually for the GS1-128 symbology and the programming for this works the same way as Label ID. See [Label ID: Set Individually Per Symbology](#), starting on page 249 for detailed instructions on setting this feature.



Set AIM ID Individually for GS1-128 = Disable



Set AIM ID Individually for GS1-128 = Enable



Label ID

A Label ID is a customizable code of up to three ASCII characters (convert to Hex using the ASCII Chart on the inside back cover of this manual), used to identify a bar code symbology type. It can be appended previous to or following the transmitted bar code data depending upon how this option is enabled. This feature provides options for configuring custom Label IDs or individually per symbology (see "Individually Set Label ID" on page 49). If you wish to program the reader to always include an industry standard label identifier for ALL symbology types, see the previous feature "Global AIM ID" on page 45.

See Label ID, starting on page 246 of "References" for more information on setting this feature.

Label ID: Pre-Loaded Sets

The reader supports two pre-loaded sets of Label IDs. See [Label ID: Pre-loaded Sets](#), starting on page 246 for details on the USA set and EU set.



Unlike some programming features and options, this feature requires that you scan only one programming bar code label. **DO NOT** scan an ENTER/EXIT bar code prior to scanning the bar codes below.



CAUTION

When changing from one Label ID set to another, all other reader configuration settings, including the host interface type, will be erased and set to the standard factory defaults. Any custom configuration or custom defaults will be lost.



If your reader came pre-loaded with a custom configuration, the default ID may differ from that indicated below.

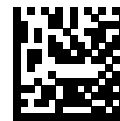
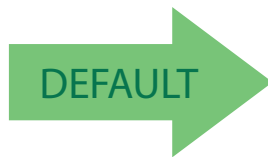

Label ID Pre-loaded Set = USA Set



Label ID Pre-loaded Set = EU Set

Individually Set Label ID

This feature configures a Label ID individually for a single symbology. To set, first define whether you want it as a prefix or suffix by scanning a label below. Then turn to [Label ID Symbology Selection – 1D Symbologies](#), starting on [page 50](#) to select the symbology you want to set, followed by up to 3 characters from the ASCII Chart at the back of this manual. See "[Label ID: Set Individually Per Symbology](#)" on [page 249](#) for detailed instructions on setting this feature.

Label ID Control

This option controls whether a Label ID is disabled, or sent as a prefix or suffix for a given symbology type.

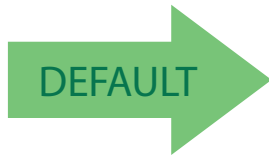

Label ID Transmission = Disable



Label ID Transmission = Enable as Prefix



Label ID Transmission = Enable as Suffix



Label ID Symbology Selection – 1D Symbologies

This option selects the symbology for which a Label ID is to be configured. See "Label ID" on page 48 or page 249 in "References" for more detailed instructions.



If less than the expected string of 3 characters are selected, scan the ENTER/EXIT bar code twice to accept the selection and exit Programming Mode.



Set ABC Codabar Label ID Character(s)



Set Code 32 Pharmacode Label ID Character(s)



Set Anker Plessey Label ID Character(s)



Set Code 93 Label ID Character(s)



Set Australian Postal Code Label ID Character(s)



Set Concatenated ISBT 128 Label ID Character(s)



Set Codabar Label ID Character(s)



Set Danish PPT Label ID Character(s)



Set Code 11 Label ID Character(s)



Set EAN 13 Label ID Character(s)



Set Code 128 Label ID Character(s)



Set EAN 13 Composite Label ID Character(s)



Set Code 39 Label ID Character(s)



Set EAN 13 P2 Label ID Character(s)

Label ID Symbology Selection – 1D Symbologies (continued)



Set Code 39 CIP Label ID Character(s)



Set EAN 13 P5 Label ID Character(s)



Set EAN 8 Label ID Character(s)



Set GS1 DataBar Expanded Composite Label ID Character(s)



Set EAN 8 Composite Label ID Character(s)



Set GS1-128 Label ID Character(s)



Set EAN 8 P2 Label ID Character(s)



Set GS1-128 Composite Label ID Character(s)



Set EAN 8 P5 Label ID Character(s)



Set GSI DataBar Limited Label ID Character(s)



Set Follett 2 of 5 Label ID Character(s)



GSI DataBar Limited Composite Label ID Character(s)



Set GS1 DataBar 14 Label ID Character(s)



Set GTIN 2 Label ID Character(s)



Set GS1 DataBar 14 Composite Label ID Character(s)



Set GTIN 5 Label ID Character(s)



Label ID Symbology Selection – 1D Symbologies (continued)



Set GS1 DataBar Expanded Label ID Character(s)



Set GTIN 8 Label ID Character(s)



Set IATA Industrial 2 of 5 Label ID Character(s)



Set LaPoste Code 39 Label ID Character(s)



Set IMB Postal Code Label ID Character(s)



Set MSI Label ID Character(s)



Set Industrial 2 of 5 Label ID Character(s)



Set Planet Postal Code Label ID Character(s)



Set Interleaved 2 of 5 Label ID Character(s)



Set Plessey Label ID Character(s)



Set ISBN Label ID Character(s)



Set Portugal Postal Code Label ID Character(s)



Set ISSN Label ID Character(s)



Set Postnet Label ID Character(s)



Set Japan Postal Code Label ID Character(s)



Set Kix Postal Code Label ID Character(s)

Label ID Symbology Selection – 1D Symbologies (continued)



Set PZN Code Label ID Character(s)



Set Postnet BB Label ID Character(s)



Set Royal Postal Code Label ID Character(s)



Set UPC-A Composite Label ID Character(s)



Set Standard 2 of 5 Label ID Character(s)



Set UPC-A P2 Label ID Character(s)



Set Swedish Postal Code Label ID Character(s)



Set UPC-A P5 Label ID Character(s)



Set Trioptic Code Label ID Character(s)



Set UPC-E Label ID Character(s)



Set UPC-A Label ID Character(s)



Set UPC-E P5 Label ID Character(s)



Label ID Symbology Selection – 2D Symbologies



Set Aztec Label ID Character(s)



Set Maxicode Label ID Character(s)



Set China Sensible Label ID Character(s)



Set PDF 417 Label ID Character(s)



Set Codablock F Label ID Character(s)



Set Micro PDF 417 Label ID Character(s)



Set Data Matrix Label ID Character(s)



Set QR Code Label ID Character(s)



Set Micro QR Label ID Character(s)

No Read Message

This feature Enables/Disables the No Read Message feature. When Disabled, nothing is sent if the trigger is pressed and released when no code has been decoded during a reading phase. Otherwise, the No Read String is sent. (See "No Read String" on page 252 to configure No Read String data)



Disabled



Enabled

No Read String

This feature defines the string or character to be displayed in case of No Read during a reading phase (On Line and Serial On Line Modes only). It allows up to 20 characters, from the set of ASCII characters or any hex value from 00 to FE.



Select No Read String

To configure this feature, scan the ENTER/EXIT PROGRAMMING MODE barcode above, then the barcode at left followed by the digits (in hex) from the Alphanumeric characters in [Appendix D on page 289](#) representing your desired character(s). If less than the expected string of 20 characters are selected, scan the ENTER/EXIT barcode to terminate the string. End by scanning the ENTER/EXIT barcode again.

Make a mistake? Scan the CANCEL barcode to abort and not save the entry string. You can then start again at the beginning.



CANCEL

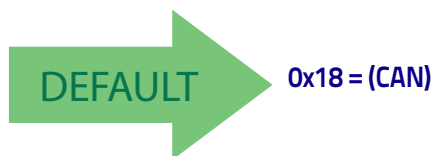

See "No Read String" on page 252 for more information on setting this feature.



CODE VERIFIER

This feature allows the scanner to verify that all codes read and decoded match a defined string saved in its memory. It is valid when in On Line, Serial On Line, Automatic and Automatic (Object Sense) Operating Modes.

If the code read matches the code verifier Match String, then it is sent to the host through the configured port. If it does not match the code verifier Match String, you can specify whether to send either the Wrong Code or a defined Wrong String message to indicate the error.

See "Code Verifier" on page 252 in References for more information about these features.

Code Verifier Mode

Disable or specify parameters for Code Verifier Mode. See "Code Verifier Mode" on page 252 in References for more information.



Disabled



DEFAULT



Transmit Wrong String



Transmit Wrong Code

Match String

This feature allows you to define the string to be used as the match code for Code Verification. The Match String must be configured to include start/stop characters and check digits if their transmission is enabled. See "Match String" on page 252 in References for more information.

It is possible to define the Match string by inserting:

- all printable characters
- non printable ASCII characters

No wild card characters are supported.

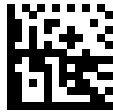

Set Match String

To configure this feature, scan the ENTER/EXIT PROGRAMMING MODE barcode above, then the barcode at left followed by the digits (in hex) from the Alphanumeric characters in [Appendix D on page 289](#) representing your desired character(s). End by scanning the ENTER/EXIT barcode again.

Make a mistake? Scan the CANCEL barcode to abort and not save the entry string. You can then start again at the beginning.



CANCEL

Wrong Code String

See "Wrong Code String" on page 253 in References for more information about this feature.

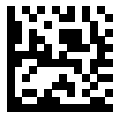

Set Wrong Code String

To configure this feature, scan the ENTER/EXIT PROGRAMMING MODE barcode above, then the barcode at left followed by the digits (in hex) from the Alphanumeric characters in [Appendix D on page 289](#) representing your desired character(s). End by scanning the ENTER/EXIT barcode again.

Make a mistake? Scan the CANCEL barcode to abort and not save the entry string. You can then start again at the beginning.



CANCEL



Label Transmit Mode

Specifies whether the decoded label must be transmitted to the host as it has been decoded or after the reading phase has been deactivated (Phase Off).



Phase Off

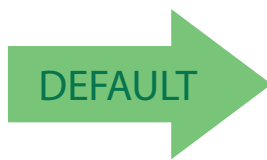

On Decode

Advanced Formatting: User Label Edit

Advanced formatting is available to create user label edit scripts. See the Datalogic Aladdin configuration application or contact Technical Support.



Case Conversion

This feature allows conversion of the case of all alphabetic characters to upper or lower case.



Case conversion affects **ONLY** scanned bar code data, and does not affect Label ID, Prefix, Suffix, or other appended data.

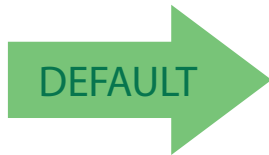

Case Conversion = Disable (no case conversion)



Case Conversion = Convert to upper case



Case Conversion = Convert to lower case

Character Conversion

Character conversion is an eight byte configuration item. The eight bytes are 4 character pairs represented in hexadecimal ASCII values. The first character in the pair is the character that will be converted. The second character in the pair is the character to convert to. If the character to convert in a pair is FF, then no conversion is done.



If less than the expected string of 16 characters are selected, scan the ENTER/EXIT bar code twice to accept the selections and exit Programming Mode.



Configure Character Conversion

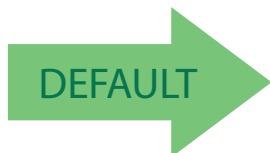

OxFFFFFFFFFFFFFFF
(No character conversion)



NOTES

READING PARAMETERS

DOUBLE READ TIMEOUT on page 62	GOOD READ BEEP FREQUENCY on page 64
LED AND BEEPER INDICATORS on page 63	GOOD READ BEEP LENGTH on page 65
POWER ON ALERT on page 63	GOOD READ BEEP VOLUME on page 66
GOOD READ: WHEN TO INDICATE on page 63	GOOD READ LED DURATION on page 67
GOOD READ BEEP TYPE on page 64	
SCANNING FEATURES	
OPERATING MODE on page 68	AIMING DURATION TIMER on page 73
PHASE OFF EVENT on page 69	GREEN SPOT DURATION on page 74
PHASE OFF TIMEOUT on page 69	MOBILE PHONE MODE on page 74
SERIAL START CHARACTER on page 70	MOBILE BIAS on page 75
SERIAL STOP CHARACTER on page 70	PARTIAL LABEL READING CONTROL on page 75
MANUAL TRIGGER CONTROL on page 71	DECODE NEGATIVE IMAGE on page 76
CENTRAL CODE ONLY on page 71	IMAGE CAPTURE on page 76
SCANNING ACTIVE TIME on page 72	MULTIPLE LABELS PER FRAME on page 77
PRESENTATION ILLUMINATION CONTROL on page 72	MULTIPLE LABELS ORDERING BY CODE SYMBOLOGY on page 78
AIMING POINTER on page 73	MULTIPLE LABELS ORDERING BY CODE LENGTH on page 78



Double Read Timeout

Double Read Timeout specifies the minimum time between consecutive good reads of labels of the same symbology and data. This prevents a double read of the same label. If the unit reads a label and sees the same label again within the specified timeout, the second read is ignored. Double Read Timeout does not apply to scan modes that require a trigger pull for each label read. The timeout can be set within a range of 20 milliseconds to 2,550 milliseconds (2.55 seconds) in 10ms increments.



Double Read Timeout = 0.1 Second



Double Read Timeout = 0.5 Second



Double Read Timeout = 1 Second



To specify your own setting, scan the bar code below followed by the appropriate characters from Appendix D, Keypad. See page 254 in “References” for detailed instructions and examples for setting this feature.



Select Double Read Timeout Setting

Make a mistake? Scan the CANCEL bar code to abort and not save the entry string. You can then start again at the beginning.



CANCEL



LED AND BEEPER INDICATORS

Power On Alert

Disables or enables the indication (from the Beeper) that the reader is receiving power.



Power On Alert = Disable (No Audible Indication)



Power On Alert = Power-up Beep

Good Read: When to Indicate

This feature specifies when the reader will provide indication (beep and/or flash its green LED) upon successfully reading a bar code.

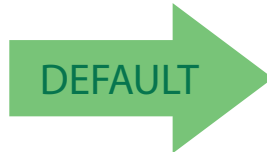

Indicate Good Read = After Decode



Indicate Good Read = After Transmit



Indicate Good Read =
After CTS goes inactive then active



Good Read Beep Type

Specifies whether the good read beep has a mono or bitonal beep sound.

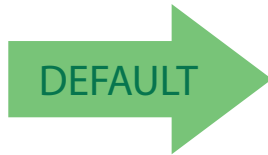

Good Read Beep Type = Mono



Good Read Beep Type = Bitonal

Good Read Beep Frequency

Adjusts the good read beep to sound at a selectable low, medium or high frequency, selectable from the list below. (Controls the beeper's pitch/ tone.)



Good Read Beep Frequency = Low



Good Read Beep Frequency = Medium



Good Read Beep Frequency = High

Good Read Beep Length





Good Read Beep Volume

Selects the beeper volume (loudness) upon a good read beep. There are three selectable volume levels.



Good Read Beep Volume = Beeper Off



Good Read Beep Volume = Low



Good Read Beep Volume = Medium



Good Read Beep Volume = High



Good Read LED Duration

This feature specifies the amount of time that the Good Read LED remains on following a good read. The good read LED on time can be set within a range of 100 milliseconds to 25,500 milliseconds (0.1 to 25.5 seconds) in 100ms increments. A setting of 00 keeps the LED on until the next trigger push.

See page 255 in “References” for detailed instructions and examples for setting this feature.



Good Read LED Duration Setting =
Keep LED on until next trigger push

To configure this feature, scan the ENTER/EXIT PROGRAMMING MODE bar code above, then the bar code at left followed by the digits from the Alphanumeric characters in [Appendix D, Keypad](#) representing your desired character(s). End by scanning the ENTER/EXIT bar code again.



Select Good Read LED Duration Setting

Make a mistake? Scan the CANCEL bar code to abort and not save the entry string. You can then start again at the beginning.



CANCEL

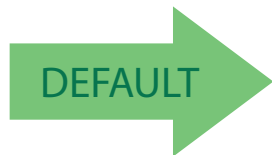

003 = Good Read LED stays on for 300 ms.



SCANNING FEATURES

Operating Mode

Selects the reader's scan operating mode. See page 256 in "References" for descriptions.



On Line (Single Trigger)



Serial On Line



Automatic (Always On)

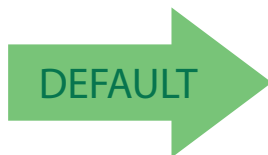

Automatic (Object Sense)



Phase Off Event



Trigger Stop



Timeout



Trigger Stop - Timeout

Phase Off Timeout

Timeout can be set within a range of 1 second to 255 seconds in 1 second intervals.



Scanning Active Time

To configure this feature scan the ENTER/EXIT PROGRAMMING MODE barcode above, then the barcode at left, followed by the digits (in hex) from the Alphanumeric characters in Appendix D, Keypad representing your desired character(s). End by scanning the ENTER/EXIT barcode again.

Make a mistake? Scan the CANCEL barcode to abort and not save the entry string. You can then start again at the beginning.



CANCEL

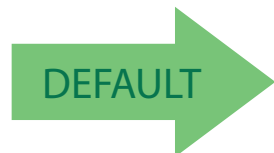

5 = Timeout set for 5 seconds



Serial Start Character

See page 256 in “References” for more information.



Select Serial Start Characters

To configure this feature scan the ENTER/EXIT PROGRAMMING MODE barcode above, then the barcode at left, followed by the digits (in hex) from the Alphanumeric characters in Appendix D, Keypad representing your desired character(s). End by scanning the ENTER/EXIT barcode again.

Make a mistake? Scan the CANCEL barcode to abort and not save the entry string. You can then start again at the beginning.



CANCEL

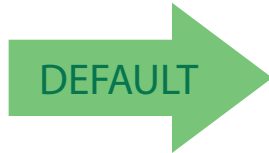

0x02 = Serial Start Character is [02 STX]

Serial Stop Character

See page 256 in “References” for more information.



Select Serial Stop Characters

To configure this feature scan the ENTER/EXIT PROGRAMMING MODE barcode above, then the barcode at left, followed by the digits (in hex) from the Alphanumeric characters in Appendix D, Keypad representing your desired character(s). End by scanning the ENTER/EXIT barcode again.

Make a mistake? Scan the CANCEL barcode to abort and not save the entry string. You can then start again at the beginning.



CANCEL

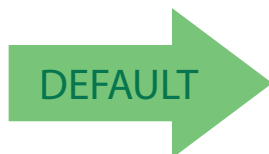

0x03 = Serial Stop Character is [03 ETX]



The Serial Start/Stop Characters must be different and must not contain reserved characters (see Appendix E, Host Configuration Reserved Characters)

Manual Trigger Control



This feature is available in Serial On Line mode only.

This feature is used to enable/disable manual trigger when the reader is in Serial On Line reading mode.

- Enable: allows a manual trigger push to start a reading phase.
- Disable: (default) locks out the trigger button and does not allow manual triggering to start a reading phase. When disabled, the trigger can still be activated once by pressing and holding the trigger for 5 seconds to enter Debug Mode.

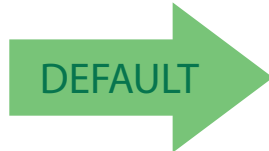

Manual Trigger Control = Disable



Manual Trigger Control = Enable

Central Code Only

Specifies the ability of the reader to decode labels only when they are close to the center of the aiming pattern. This allows the reader to accurately target labels when they are placed close together, such as on a pick sheet.



This feature is not compatible with Multiple Labels Reading in a Volume.

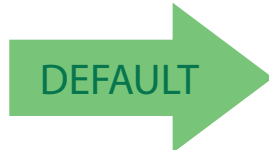

Central Code Only = Disable



Central Code Only = Enable



Scanning Active Time

This setting specifies the amount of time that the reader stays in scan ON state once the state is entered. The range for this setting is from 1 to 255 seconds in 1-second increments. See page 258 in "References" for more.



Scanning Active Time works in On Line and Serial On Line Read modes as the Timeout Phase Off Event. See also "Phase Off Timeout" on page 69.

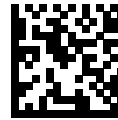

Scanning Active Time = 3 seconds



Scanning Active Time = 5 seconds

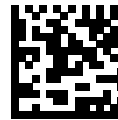

Scanning Active Time = 8 seconds

Presentation Illumination Control

Controls the illumination status when in Automatic Trigger Object Sense Operating Mode and the reader is attempting to detect objects.



Illumination Control = OFF



Illumination Control = ON



Illumination Control = Dim

Aiming Pointer

Enables/disables the aiming pointer for all symbologies.



Aiming Duration Timer

Specifies the time the aiming pointer remains on after decoding a label, when in On Line or Serial On Line mode. The range for this setting is from 1 to 255 seconds in 1-second increments. See page 259 in “References”.

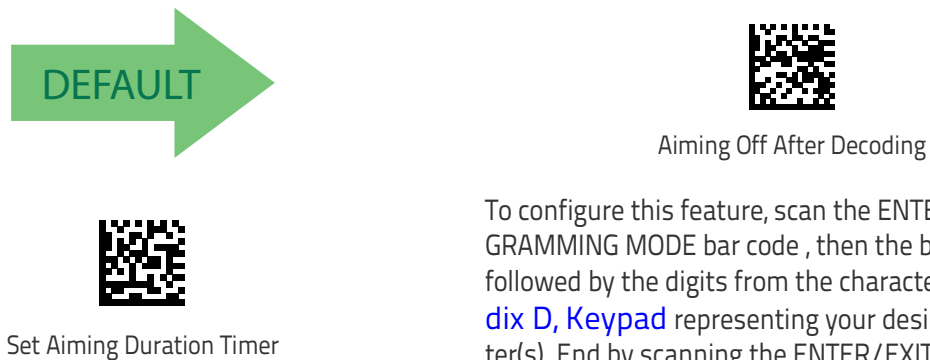

To configure this feature, scan the ENTER/EXIT PROGRAMMING MODE bar code, then the bar code at left followed by the digits from the characters in [Appendix D, Keypad](#) representing your desired character(s). End by scanning the ENTER/EXIT bar code again.

Make a mistake? Scan the CANCEL bar code to abort and not save the entry string. You can then start again at the beginning.





Green Spot Duration

Specifies the duration of the good read pointer beam after a good read.

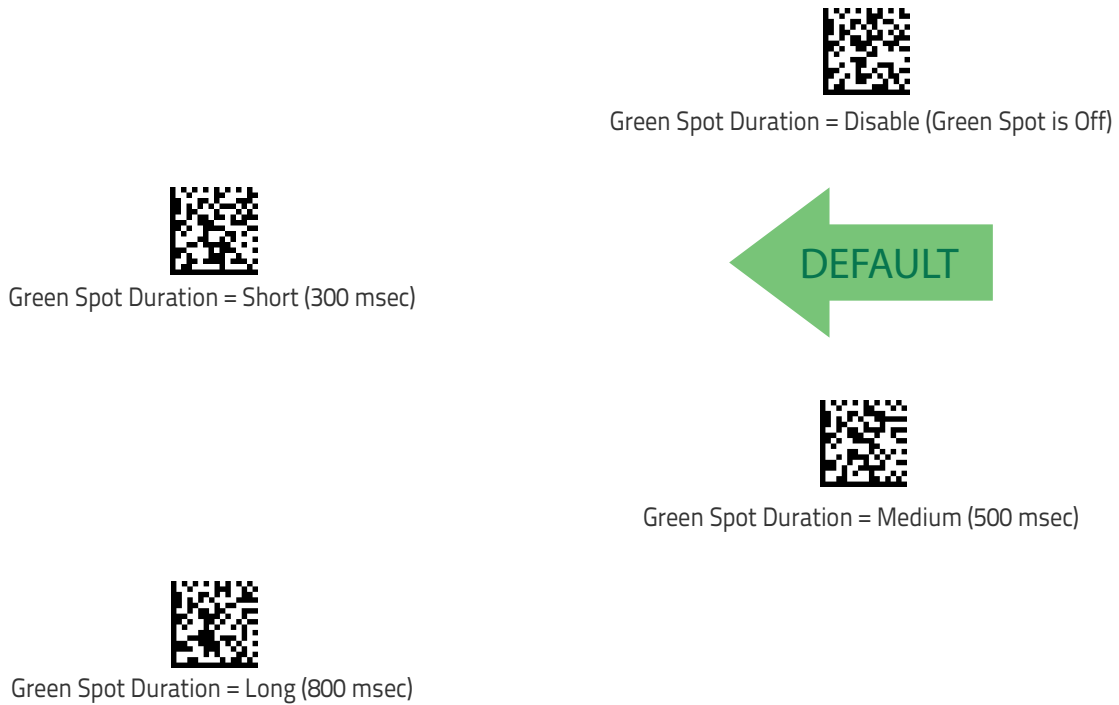

Mobile Phone Mode

This mode is useful for scanning bar codes displayed on a mobile phone. Other options for this feature can be configured using the Datalogic Aladdin application.





Mobile Bias

This variable mode alters scan module operation, optimizing barcode scanning for reading from mobile device displays rather than standard labels. The range for this setting is from 0 to 255.

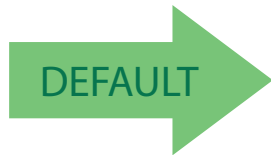

No Mobile Bias



Set Mobile Bias

To configure, scan the ENTER/EXIT PROGRAMMING MODE bar code above, then the bar code at left followed by the digits from the Alphanumeric characters in [Appendix D, Keypad](#) representing your desired character(s). End by scanning the ENTER/EXIT bar code.

Make a mistake? Scan the CANCEL bar code to abort and not save the entry string. You can then start again at the beginning.



CANCEL

Partial Label Reading Control

Enable/Disable the option to ignore partial labels to be read within the boundary of the field of view.



Partial Label Reading Control = Disable

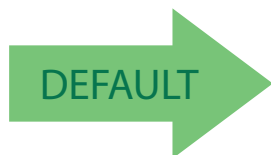

Partial Label Reading Control = Enable



Decode Negative Image

Enables/Disables decoding a negative image for all symbologies. When enabled, you cannot read normally-printed labels or programming labels in this manual. Scan the "Disable" bar code below to return the scanner to its default for this feature. To set the reader to decode only 2D codes, go to "2D Normal/Inverse Symbol Control" on page 174. For additional options, see the Aladdin configuration application.



Unlike some programming features and options, Decode Negative Image selections require that you scan only one programming bar code label. DO NOT scan an ENTER/EXIT bar code.



CAUTION

When this feature is enabled, you will be unable to read other programming labels in this manual.

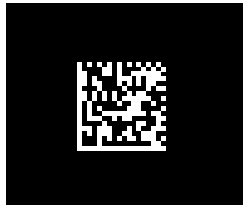

Decode Negative Image = Disable



DEFAULT



Decode Negative Image = Enable

Image Capture

For information and a list of options for Image Capture, use the Datalogic Aladdin configuration application, available for free download from the Datalogic website.

MULTIPLE LABEL READING

When the reader's aiming system is activated by a trigger push or other method (depending on the mode), it then acquires and processes each image in the area in front of it (the Volume). In this case, the scanner stops processing the image once it decodes a label. If several labels are present in the volume, only the first label encountered is decoded and sent.

When Multiple Reading Mode is enabled, the scanner keeps on processing the image until all the labels present are decoded. The reader then sorts the data from all the bar codes (if configured to do so) before transmitting it.

Multiple Labels per Frame

Specifies the ability of the reader to decode and transmit a set of code labels in a specific volume and in a single frame of time. When in Multiple Labels per Frame the reader beeps and turns on the good read LED indication for each code read in a frame.

When Multiple Labels Mode is enabled, ISBT pairing, ABC Codabar pairing, and composites are not allowed.

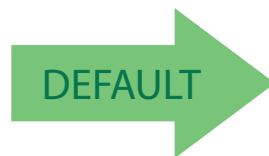

Multiple Labels per Frame = Disable



Multiple Labels per Frame = Enable



Multiple Labels Ordering by Code Symbology

This feature allows you to specify the order multiple labels are transmitted by symbology type, when Multiple Labels per Frame is enabled. See page 260 in "References" for detailed information on setting this feature.



Select Symbologies for Multiple Labels Ordering

To configure, scan the ENTER/EXIT PROGRAMMING MODE bar code above, then the bar code at left followed by the digits from the Alphanumeric characters in [Appendix D, Keypad](#) representing your desired character(s). End by scanning the ENTER/EXIT bar code.

Make a mistake? Scan the CANCEL bar code to abort and not save the entry string. You can then start again at the beginning.



CANCEL

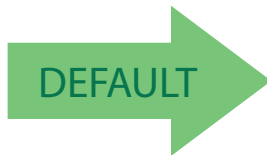

00000000000 = Random order

Multiple Labels Ordering by Code Length

Specifies the transmission ordering by code length, when Multiple Labels per Frame is enabled.

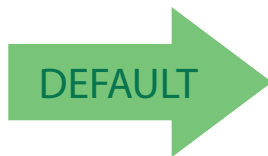

Multiple Labels Ordering = Disable



Transmit Increasing Length Order



Transmit Decreasing Length Order

1D SYMBOLOGIES

1D Code Selection

The reader supports the following 1D symbologies (bar code types). See "2D Symbologies" starting on page 171 for 2D bar codes. Symbology-dependent options are included in each chapter.

▪ Disable All Symbologies, page 80	▪ GS1-128, page 118
▪ Code EAN/UPC, page 81	▪ Code ISBT 128, page 119
▪ UPC-E, page 84	▪ Interleaved 2 of 5 (I 2 of 5), page 122
▪ GTIN Formatting, page 87	▪ Interleaved 2 of 5 CIP HR, page 127
▪ EAN 13 (Jan 13), page 88	▪ Follett 2 of 5, page 127
▪ ISSN, page 90	▪ Standard 2 of 5, page 128
▪ EAN 8 (Jan 8), page 91	▪ Industrial 2 of 5, page 132
▪ UPC/EAN Global Settings, page 93	▪ Code IATA, page 136
▪ Add-Ons, page 95	▪ Codabar, page 137
▪ Code 39, page 102	▪ ABC Codabar, page 143
▪ Trioptic Code, page 108	▪ Code 11, page 146
▪ Code 32 (Ital Pharmaceutical Code), page 108	▪ GS1 DataBar™ Omnidirectional, page 150
▪ Code 39 CIP (French Pharmaceutical), page 110	▪ GS1 DataBar™ Expanded, page 151
▪ Code 39 Danish PPT, page 110	▪ GS1 DataBar™ Limited, page 156
▪ Code 39 LaPoste, page 111	▪ Code 93, page 157
▪ Code 39 PZN, page 111	▪ MSI, page 162
▪ Code 128, page 112	▪ Plessey, page 167

Default settings are indicated at each feature/option with a green arrow. Also reference [Appendix B, Standard Defaults](#) for a listing of the most widely used set of standard factory settings. That section also provides space to record any custom settings needed or implemented for your system.

To set most features:

1. Scan the ENTER/EXIT PROGRAMMING bar code at the top of applicable programming pages.
2. Scan the correct bar code to set the desired programming feature or parameter. You may need to cover unused bar codes on the page, and possibly the facing page, to ensure that the reader reads only the bar code you intend to scan.
3. If additional input parameters are needed, go to [Appendix D, Keypad](#), and scan the appropriate characters from the keypad.



Additional information about many features can be found in References, starting on page 231.

If you make a mistake before the last character, scan the CANCEL bar code to abort and not save the entry string. You can then start again at the beginning.

4. Complete the programming sequence by scanning the ENTER/EXIT PROGRAMMING bar code to exit Programming Mode.

DISABLE ALL SYMBOLOGIES

Use this feature to disable all symbologies.

1. Scan the ENTER/EXIT PROGRAMMING Mode bar code.
2. Scan the Disable All Symbologies bar code.
3. Complete the programming sequence by scanning the ENTER/EXIT PROGRAMMING bar code.



Disable All Symbologies



This does not disable the reading of programming labels.



CODE EAN/UPC

Coupon Control

This feature is used to control the reader's method of processing coupon labels.



Coupon Control = Allow all coupon bar codes to be decoded



Coupon Control = Enable only UPCA coupon decoding



Coupon Control = Enable only GS1 DataBar™ coupon decoding



UPC-A

The following options apply to the UPC-A symbology.

UPC-A Enable/Disable

When disabled, the reader will not read UPC-A bar codes.



UPC-A Check Character Transmission

Enable this option to transmit the check character along with UPC-A bar code data.

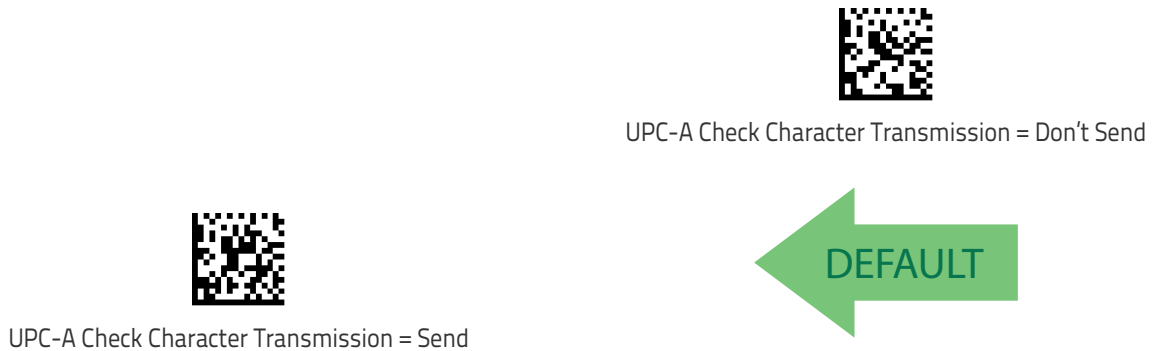

Expand UPC-A to EAN-13

Expands UPC-A data to the EAN-13 data format. Selecting this feature also changes the symbology ID to match those required for EAN-13.

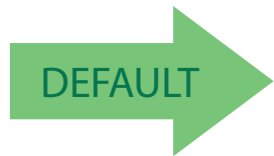

UPC-A to EAN-13 = Don't Expand



UPC-A to EAN-13 = Expand

UPC-A Number System Character Transmission

This feature enables/disables transmission of the UPC-A number system character.



UPC-A Number System Character = Do not transmit



UPC-A Number System Character = Transmit





UPC-A 2D Component

This feature enables/disables a requirement that a 2D label component be decoded when a base label of this symbology is decoded.

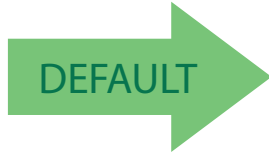

EAN-13 2D Component = Disable (2D component not required)



EAN-13 2D Component = 2D component must be decoded

UPC-E

The following options apply to the UPC-E symbology.

UPC-E Enable/Disable

When disabled, the reader will not read UPC-E bar codes.



UPC-E = Disable



UPC-E = Enable





UPC-E Check Character Transmission

Enable this option to transmit the check character along with UPC-E bar code data.



UPC-E Check Character Transmission = Don't Send



UPC-E Check Character Transmission = Send

UPC-E 2D Component

This feature enables/disables a requirement that a 2D label component be decoded when a base label for this symbology is decoded.

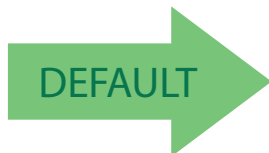

UPC-E 2D Component =
Disable (2D component not required)



UPC-E 2D Component =
2D component must be decoded



Expand UPC-E to EAN-13

Expands UPC-E data to the EAN-13 data format. Selecting this feature also changes the symbology ID to match those required for EAN-13.

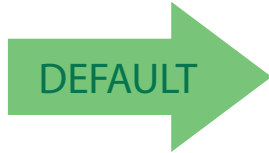

UPC-E to EAN-13 = Don't Expand



UPC-E to EAN-13 = Expand

Expand UPC-E to UPC-A

Expands UPC-E data to the UPC-A data format.

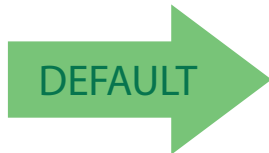

UPC-E to UPC-A = Don't Expand



UPC-E to UPC-A = Expand



UPC-E Number System Character Transmission

This feature enables/disables transmission of the UPC-E system number character.



UPC-E Number System Character = Do not transmit



UPC-E Number System Character = Transmit

GTIN FORMATTING

This feature enables/disables the ability to convert UPC-E, UPC-A, EAN 8, and EAN 13 labels into the GTIN 14-character format.



If add-on information is present on the base label prior to the conversion taking place, the add-on information will be appended to the converted GTIN label.

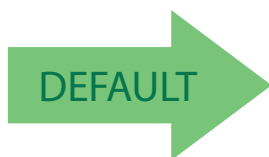

GTIN Formatting = Disable



GTIN Formatting = Enable



EAN 13 (JAN 13)

The following options apply to the EAN 13 (Jan 13) symbology.

EAN 13 Enable/Disable

When disabled, the reader will not read EAN 13/JAN 13 bar codes.



EAN 13 Check Character Transmission

Enable this option to transmit the check character along with EAN 13 bar code data.

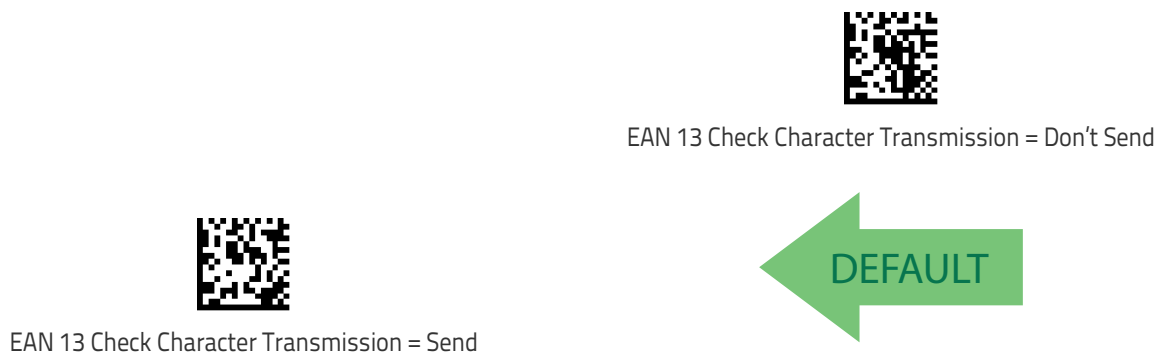

EAN-13 Flag 1 Character

Enables/disables transmission of an EAN/JAN13 Flag1 character. The Flag 1 character is the first character of the label.

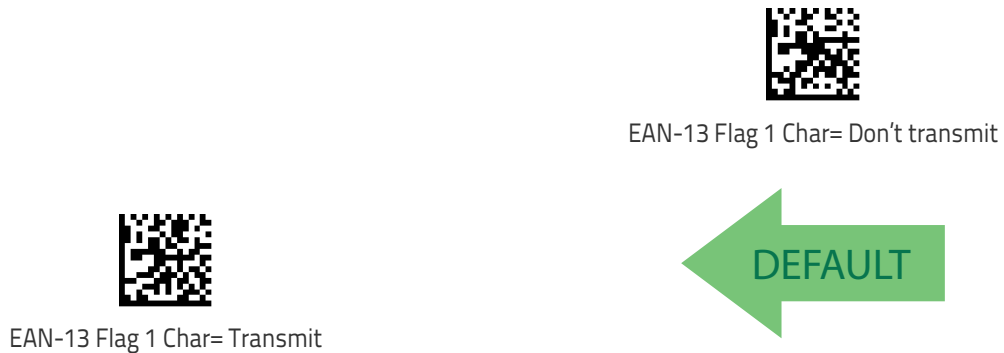

EAN-13 ISBN Conversion

This option enables/disables conversion of EAN 13/JAN 13 Bookland labels starting with 978 to ISBN labels.





EAN-13 2D Component

This feature enables/disables a requirement that a 2D label component be decoded when a base label of this symbology is decoded.

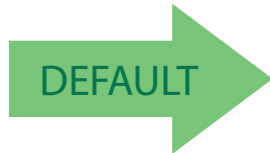

EAN-13 2D Component =
Disable (2D component not required)



EAN-13 2D Component =
2D component must be decoded

ISSN

The following options apply to the ISSN symbology.

ISSN Enable/Disable

Enables/disables conversion of EAN/JAN13 Bookland labels starting with 977 to ISSN labels.

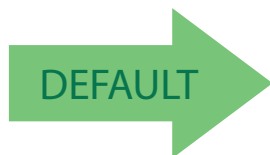

ISSN = Disable



ISSN = Enable



EAN 8 (JAN 8)

The following options apply to the EAN 8 (Jan 8) symbology.

EAN 8 Enable/Disable

When disabled, the reader will not read EAN 8/JAN 8 bar codes.



EAN 8 Check Character Transmission

Enable this option to transmit the check character along with EAN 8 bar code data.

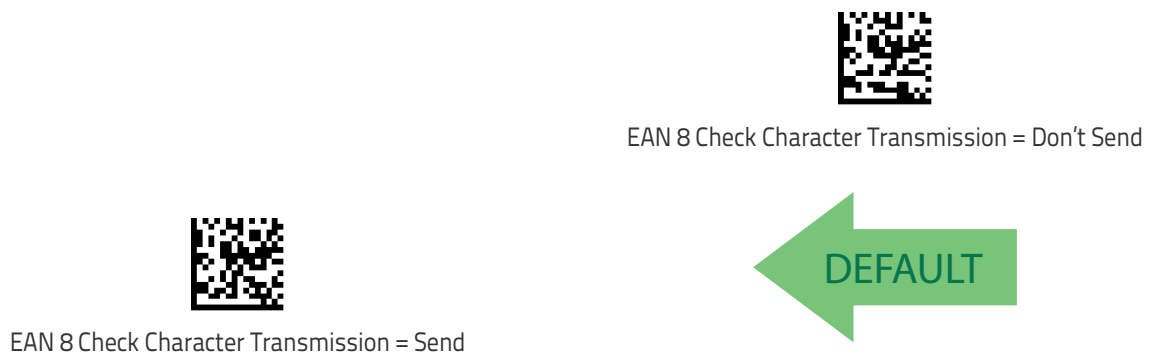



Expand EAN 8 to EAN 13

Enable this option to expand EAN 8/JAN 8 labels to EAN 13/JAN 13.

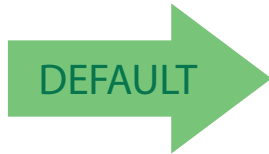

Expand EAN 8 to EAN 13 = Disable



Expand EAN 8 to EAN 13 = Enable

EAN 8 2D Component

This feature enables/disables a requirement that a 2D label component be decoded when a base label for this symbology is decoded.

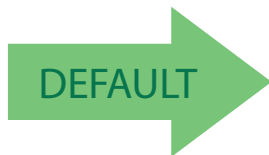

EAN 8 2D Component =
Disable (2D component not required)



EAN 8 2D Component =
2D component must be decoded



UPC/EAN GLOBAL SETTINGS

This section provides configuration settings for UPC-A, UPC-E, EAN 13 and EAN 8 symbologies, and affects all of these unless otherwise marked for each feature description.

UPC/EAN Price Weight Check

This feature enables/disables calculation and verification of price/weight check digits.

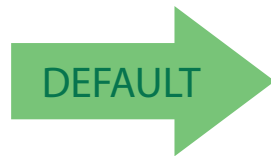

Price Weight Check = Disabled



Price Weight Check = 4-digit price-weight check



Price Weight Check = 5-digit price-weight check



Price Weight Check = European 4-digit price-weight check



Price Weight Check = European 5-digit price-weight check



UPC/EAN Quiet Zones

This feature specifies the number of quiet zones for UPC/EAN labels. Quiet zones are blank areas at the ends of a bar code, typically 10 times the width of the narrowest bar or space in the label. The property applies to all EAN-UPC symbologies globally and to the ADDONs.

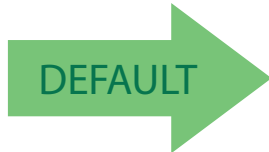

UPC/EAN Quiet Zones = Two Modules



UPC/EAN Quiet Zones = Three Modules

ADD-ONS

Contact Customer Support for advanced programming of optional and conditional add-ons.

Optional Add-ons

The reader can be enabled to optionally read the following add-ons (supplementals):



If a UPC/EAN base label and an add-on are both decoded, the reader will transmit both. If a UPC/EAN base label is decoded without an add-on, the base label will be transmitted without an add-on. Conditional add-on settings (if enabled) are considered by the reader before optional add-on settings.

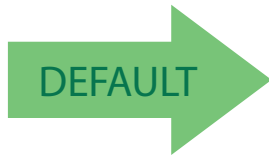

Optional Add-Ons = Disable P2



Optional Add-Ons = Enable P2

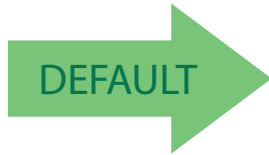

Optional Add-Ons = Disable P5



Optional Add-Ons = Enable P5

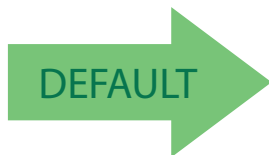

Optional Add-Ons = Disable GS1-128



Optional Add-Ons = Enable GS1-128



Optional Add-On Timer

This option sets the time the reader will look for an add-on when an add-on fragment has been seen and optional add-ons are enabled. (Also see "Optional GS1-128 Add-On Timer" on page 99.)



Optional Add-On Timer = 10ms



Optional Add-On Timer = 20ms



Optional Add-On Timer = 30ms



Optional Add-On Timer = 40ms



Optional Add-On Timer = 50ms

Optional Add-On Timer (continued)





Optional Add-On Timer (continued)



Optional Add-On Timer = 180ms



Optional Add-On Timer = 200ms



Optional Add-On Timer = 220ms



Optional Add-On Timer = 240ms



Optional Add-On Timer = 260ms



Optional Add-On Timer = 280ms



Optional Add-On Timer = 300ms

Optional GS1-128 Add-On Timer

This option sets the timer expiration value to read the added part after reading the linear EAN/UPC part. For UPC/EAN add-ons other than those of that type, see "Optional Add-On Timer" on page 96.

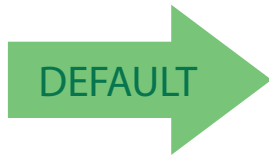

Optional GS1-128 Add-On Timer = Disable



Optional GS1-128 Add-On Timer = 10ms



Optional GS1-128 Add-On Timer = 20ms



Optional GS1-128 Add-On Timer = 30ms



Optional GS1-128 Add-On Timer = 40ms



Optional GS1-128 Add-On Timer = 50ms



Optional Add-On Timer (continued)



Optional GS1-128 Add-On Timer = 60ms



Optional GS1-128 Add-On Timer = 70ms



Optional GS1-128 Add-On Timer = 100ms



Optional GS1-128 Add-On Timer = 120ms



Optional GS1-128 Add-On Timer = 140ms



Optional GS1-128 Add-On Timer = 160ms

Optional Add-On Timer (continued)



Optional GS1-128 Add-On Timer = 180ms



Optional GS1-128 Add-On Timer = 200ms



Optional GS1-128 Add-On Timer = 220ms



Optional GS1-128 Add-On Timer = 240ms



Optional GS1-128 Add-On Timer = 260ms



Optional GS1-128 Add-On Timer = 280ms



Optional GS1-128 Add-On Timer = 300ms



CODE 39

The following options apply to the Code 39 symbology.

Code 39 Enable/Disable



Code 39 = Enable



Code 39 = Disable



Code 39 Check Character Calculation

Enable this option to enables/disables calculation and verification of an optional Code 39 check character. When disabled, any check character in the label is treated as a data character



Code 39 Check Character Calculation = Don't Calculate



Code 39 Check Character Calculation =
Calculate Std Check



Code 39 Check Character Calculation =
Calculate Mod 7 Check



Code 39 Check Character Calculation (continued)



Code 39 Check Character Calculation =
Enable Italian Post Check



Code 39 Check Character Calculation =
Enable Daimler Chrysler Check

Code 39 Check Character Transmission

Enable this option to transmit the check character along with Code 39 bar code data.



Code 39 Check Character Transmission = Don't Send



Code 39 Check Character Transmission = Send





Code 39 Start/Stop Character Transmission

Enable this option to enable/disable transmission of Code 39 start and stop characters.

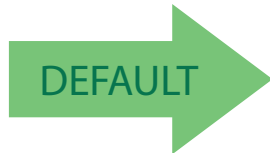

Code 39 Start/Stop Character Transmission = Don't Transmit



Code 39 Start/Stop Character Transmission = Transmit

Code 39 Full ASCII

Enables/disables the translation of Code 39 characters to Code 39 full-ASCII characters.

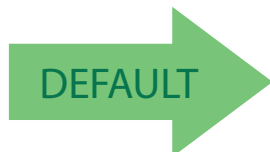

Code 39 Full ASCII = Disable



Code 39 Full ASCII = Enable

Code 39 Quiet Zones

This feature specifies the number of quiet zones for Code 39 labels. Quiet zones are blank areas at the ends of a bar code, typically 10 times the width of the narrowest bar or space in the label.



Code 39 Quiet Zones = Quiet Zones on two sides



Code 39 Quiet Zones = Small Quiet Zones on two sides

Code 39 Length Control

This feature specifies either variable length decoding or fixed length decoding for the Code 39 symbology.

Variable Length: For variable length decoding, a minimum and maximum length may be set.

Fixed Length: For fixed length decoding, two different lengths may be set.

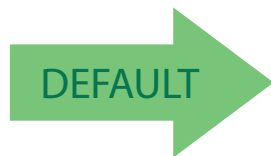

Code 39 Length Control = Variable Length



Code 39 Length Control = Fixed Length



Code 39 Set Length 1

This feature specifies one of the bar code lengths for Code 39 Length Control. Length 1 is the minimum label length if in Variable Length Mode, or the first fixed length if in Fixed Length Mode. Length includes the bar code’s data characters only. The length can be set from 0 to 50 characters.

Table 3 provides examples for setting Length 1. See page 241 for detailed instructions on setting this feature.

Table 3. Code 39 Length 1 Setting Examples

STEP	ACTION	EXAMPLES			
1	Desired Setting	00 Characters	07 Characters	15 Characters	50 Characters
2	Scan ENTER/EXIT PROGRAMMING MODE				
3	Scan SELECT CODE 39 LENGTH 1 SETTING				
4	Scan Two Characters From Appendix D, Keypad	'0' and '0'	'0' and '7'	'1' and '5'	'5' AND '0'
5	Scan ENTER/EXIT PROGRAMMING MODE				



Select Code 39 Set Length 1 Setting

Make a mistake? Scan the CANCEL bar code to abort and not save the entry string. You can then start again at the beginning.



CANCEL

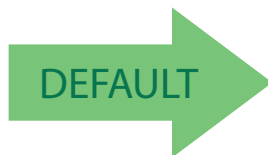

02 = Length 1 is 2 Characters

Code 39 Set Length 2

This feature specifies one of the bar code lengths for Code 39 Length Control. Length 2 is the maximum label length if in Variable Length Mode, or the second fixed length if in Fixed Length Mode. Length includes the bar code's check, data, and full-ASCII shift characters. The length does not include start/stop characters.

Table 4 provides examples for setting Length 2. See page 241 for detailed instructions on setting this feature.

Table 4. Code 39 Length 2 Setting Examples

STEP	ACTION	EXAMPLES			
1	Desired Setting	00 (Ignore This Length)	07 Characters	15 Characters	50 Characters
2	Scan ENTER/EXIT PROGRAMMING MODE				
3	Scan SELECT CODE 39 LENGTH 2 SETTING				
4	Scan Two Characters From Appendix D, Keypad	'0' and '0'	'0' and '7'	'1' and '5'	'5' AND '0'
5	Scan ENTER/EXIT PROGRAMMING .MODE				



Select Code 39 Length 2 Setting

Make a mistake? Scan the CANCEL bar code to abort and not save the entry string. You can then start again at the beginning.



CANCEL

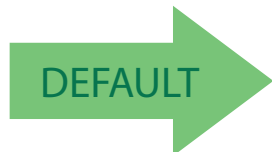

50 = Length 2 is 50 Characters



TRIOPTIC CODE

The following options apply to the Trioptic symbology.

Trioptic Code Enable/Disable

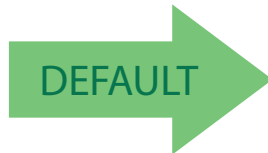

Trioptic Code = Disable



Trioptic Code = Enable

CODE 32 (ITAL PHARMACEUTICAL CODE)

The following options apply to the Code 32 (Italian Pharmaceutical Code) symbology.

Code 32 Enable/Disable

When disabled, the reader will not read Code 32 bar codes.

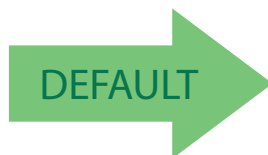

Code 32 = Disable



Code 32 = Enable

Code 32 Feature Setting Exceptions



The following features are set for Code 32 by using these Code 39 settings:

- "Code 39 Quiet Zones" on page 105
- "Code 39 Length Control" on page 105
- "Trioptic Code" on page 108

Code 32 Check Char Transmission

Enable this option to transmit the check character along with Code 32 bar code data.

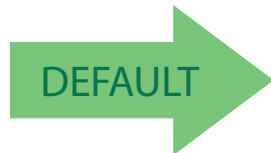

Code 32 Check Character Transmission = Don't Send



Code 32 Check Character Transmission = Send

Code 32 Start/Stop Character Transmission

This option enables/disables transmission of Code 32 start and stop characters.

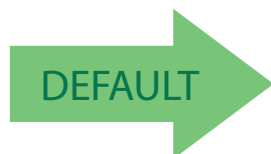

Code 32 Start/Stop Character Transmission =
Don't Transmit



Code 32 Start/Stop Character Transmission = Transmit



CODE 39 CIP (FRENCH PHARMACEUTICAL)

The following options apply to the Code 39 CIP symbology.

Code 39 CIP Enable/Disable

Enables/Disables ability of the reader to decode Code 39 CIP labels.

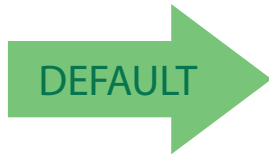

Code 39 CIP = Disable



Code 39 CIP = Enable

CODE 39 DANISH PPT

The following options apply to the Code 39 Danish PPT symbology.

Code 39 Danish PPT Enable/Disable

Enables/Disables AIM ID for Code 39 Danish PPT Codes.

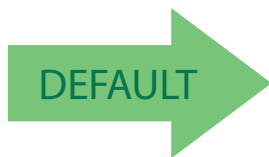

Code 39 Danish PPT = Disable



Code 39 Danish PPT = Enable



CODE 39 LAPOSTE

The following options apply to the Code 39 LaPoste symbology.

Code 39 LaPoste Enable/Disable

Enables/disables the ability of the scanner to decode Code39 La Poste labels.

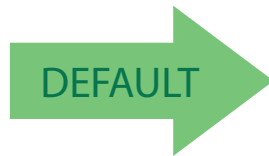

Code 39 LaPoste = Disable



Code 39 LaPoste = Enable

CODE 39 PZN

The following options apply to the Code 39 PZN symbology.

Code 39 PZN Enable/Disable

Enables/disables the ability of the scanner to decode Code39 PZN labels.

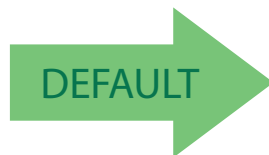

Code 39 PZN = Disable



Code 39 PZN = Enable



CODE 128

The following options apply to the Code 128 symbology.

Code 128 Enable/Disable

When disabled, the reader will not read Code 128 bar codes.



Code 128 = Enable



Code 128 = Disable



Expand Code 128 to Code 39

This feature enables/disables expansion of Code 128 labels to Code 39 labels.

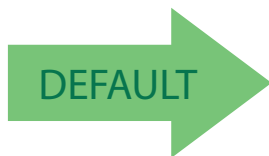

Code 128 to Code 39 = Expand



Code 128 to Code 39 = Don't Expand

Code 128 Check Character Transmission

Enable this option to transmit the check character along with Code 128 bar code data.

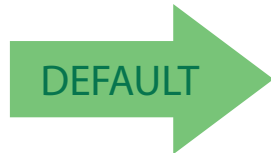

Code 128 Check Character Transmission = Don't Send



Code 128 Check Character Transmission = Send

Code 128 Function Character Transmission

Enables/disables transmission of Code128 function characters 1, 2, 3, and 4.

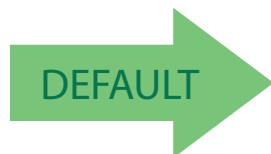

Code 128 Function Character Transmission = Don't Send



Code 128 Function Character Transmission = Send



Code 128 Sub-Code Exchange Transmission

Enables/disables the transmission of “Sub-Code Exchange” characters (NOT transmitted by standard decoding).

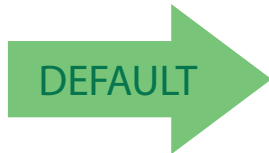

Code 128 Sub-Code Exchange Transmission = Disable



Code 128 Sub-Code Exchange Transmission = Enable

Code 128 Quiet Zones

This feature specifies the number of quiet zones for Code 128 labels. Quiet zones are blank areas at the ends of a bar code and are typically 10 times the width of the narrowest bar or space in the label.



Code 128 Quiet Zones = Quiet Zones on two sides



Code 128 Quiet Zones = Small Quiet Zones on two sides



Code 128 Length Control

This feature specifies either variable length decoding or fixed length decoding for the Code 128 symbology. See [page 241](#) for more information.

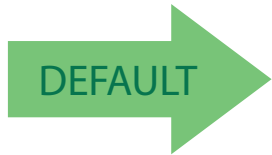

Code 128 Length Control = Variable Length



Code 128 Length Control = Fixed Length



Code 128 Set Length 1

Specifies one of the bar code lengths for Code 128 Length Control. Length 1 is the minimum label length if in Variable Length Mode, or the first fixed length if in Fixed Length Mode. Length includes the bar code’s data characters only. The length can be set from 1 to 80 characters.

Table 5 provides some examples for setting Length 1. See page 241 for detailed instructions on setting this feature.

Table 5. Code 128 Length 1 Setting Examples

STEP	ACTION	EXAMPLES			
1	Desired Setting	01 Character	07 Characters	15 Characters	80 Characters
2	Scan ENTER/EXIT PROGRAMMING MODE				
3	Scan SELECT CODE 128 LENGTH 1 SETTING				
4	Scan Two Characters From Appendix D, Keypad	'0' and '1'	'0' and '7'	'1' and '5'	'8' AND '0'
5	Scan ENTER/EXIT PROGRAMMING MODE				



Select Code 128 Set Length 1 Setting

Make a mistake? Scan the CANCEL bar code to abort and not save the entry string. You can then start again at the beginning.



CANCEL

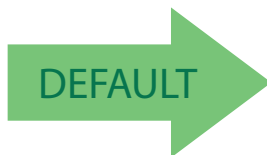

01 = Length 1 is 1 Character

Code 128 Set Length 2

This feature specifies one of the bar code lengths for Code 128 Length Control. Length 2 is the maximum label length if in Variable Length Mode, or the second fixed length if in Fixed Length Mode. Length includes the bar code’s data characters only.

The length can be set from 1 to 80 characters. A setting of 0 specifies to ignore this length (only one fixed length).

Table 6 provides examples for setting Length 2. See page 241 for detailed instructions on setting this feature.

Table 6. Code 128 Length 2 Setting Examples

STEP	ACTION	EXAMPLES			
1	Desired Setting	00 (Ignore This Length)	07 Characters	15 Characters	80 Characters
2	Scan ENTER/EXIT PROGRAMMING MODE				
3	Scan SELECT CODE 128 LENGTH 2 SETTING				
4	Scan Two Characters From Appendix D, Keypad	'0' and '0'	'0' and '7'	'1' and '5'	'8' and '0'
5	Scan ENTER/EXIT PROGRAMMING MODE				



Select Code 128 Length 2 Setting

Make a mistake? Scan the CANCEL bar code to abort and not save the entry string. You can then start again at the beginning.



CANCEL

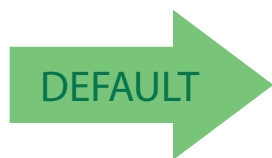

80 = Length 2 is 80 Characters



GS1-128

The following options apply to the GS1-128 symbology. (Also known as USS-128, GS1-128, GTIN-128, UCC-128, EAN-128.)

GS1-128 Enable

This option enables/disables the ability of the reader to translate GS1-128 labels to the GS1-128 data format. Options are:

- Transmit GS1-128 labels in Code 128 data format.
- Transmit GS1-128 labels in GS1-128 data format.
- Do not transmit GS1-128 labels.

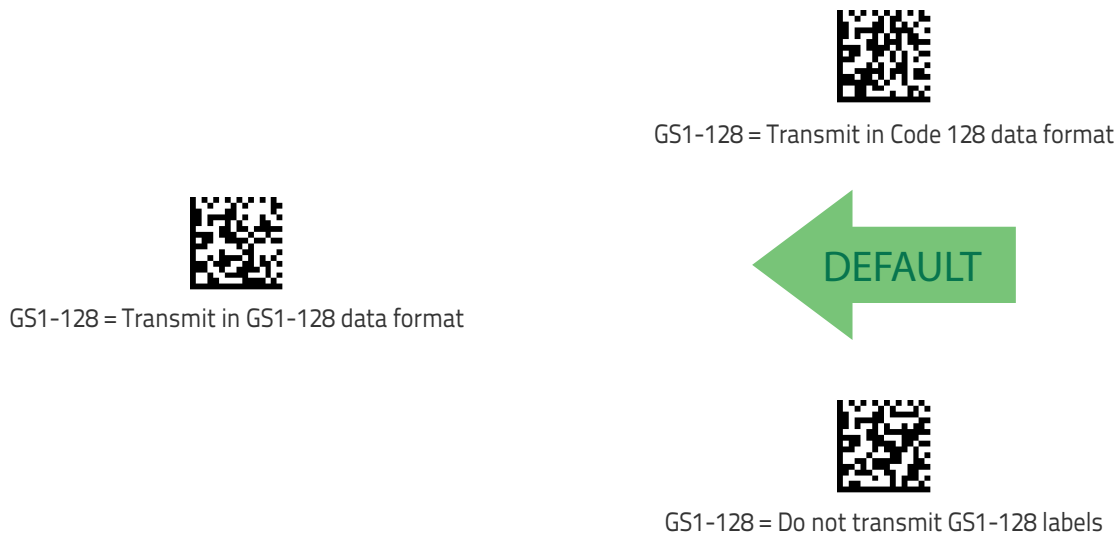

GS1-128 2D Component

This feature enables/disables a requirement that a 2D label component be decoded when a base label of this symbology is decoded.



CODE ISBT 128

The following options apply to the ISBT 128 symbology.

ISBT 128 Concatenation

Use this option to enable/disable ISBT128 concatenation of 2 labels.

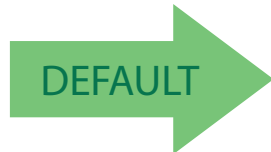

ISBT 128 Concatenation = Disable



ISBT 128 Concatenation = Enable

ISBT 128 Force Concatenation

When enabled, this feature forces concatenation for ISBT.



This option is only valid when [ISBT 128 Concatenation](#) is enabled.

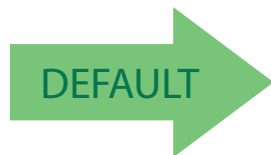

ISBT 128 Force Concatenation = Disable



ISBT 128 Force Concatenation = Enable



ISBT 128 Concatenation Mode

Specifies the concatenation mode between Static and Dynamic.



This option is only valid when ISBT 128 Concatenation is enabled (see "ISBT 128 Concatenation" on page 119).

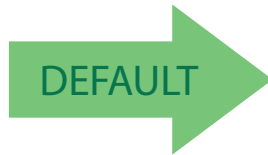

ISBT 128 Concatenation Mode = Static



ISBT 128 Concatenation Mode = Dynamic

ISBT 128 Dynamic Concatenation Timeout

Specifies the timeout used by the ISBT 128 Dynamic Concatenation Mode.



ISBT 128 Dynamic Concatenation Timeout = 50 msec



ISBT 128 Dynamic Concatenation Timeout = 100 msec

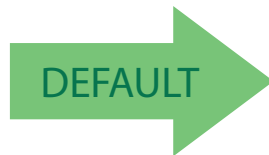

ISBT 128 Dynamic Concatenation Timeout = 200 msec



ISBT 128 Dynamic Concatenation Timeout = 500 msec



ISBT 128 Dynamic Concatenation Timeout = 750 msec



ISBT 128 Dynamic Concatenation Timeout = 1 second

ISBT 128 Advanced Concatenation Options



To set up pairs of label types for concatenation, use the Datalogic Aladdin configuration application or contact Datalogic Technical Support, as described on [page 2](#).



INTERLEAVED 2 OF 5 (I 2 OF 5)

The following options apply to the I 2 of 5 symbology.

I 2 of 5 Enable/Disable

When disabled, the reader will not read I 2 of 5 bar codes.

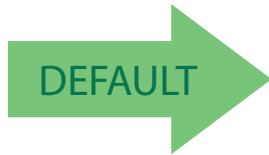

I 2 of 5 = Disable



I 2 of 5 = Enable

I 2 of 5 Check Character Calculation

This option enables/disables calculation and verification of an optional I 2 of 5 check character. Combinations of these settings are possible via the Aladdin configuration utility, or contact Technical Support.

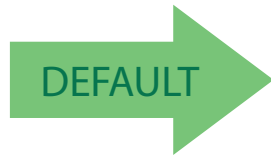

I 2 of 5 Check Character Calculation = Disable



I 2 of 5 Check Character Calculation = Check Standard
(Modulo 10)



I 2 of 5 Check Character Calculation = Check German Parcel



I 2 of 5 Check Character Calculation = Check DHL



I 2 of 5 Check Character Calculation = Check Daimler Chrysler



I 2 of 5 Check Character Calculation = Check Bosch



I 2 of 5 Check Character Calculation = Italian Post



I 2 of 5 Check Character Transmission

Enable this option to transmit the check character along with I 2 of 5 bar code data.



I 2 of 5 Check Character Transmission = Don't Send



I 2 of 5 Check Character Transmission = Send



I 2 of 5 Length Control

This feature specifies either variable length decoding or fixed length decoding for the I 2 of 5 symbology.

Variable Length: For variable length decoding, a minimum and maximum length may be set.

Fixed Length: For fixed length decoding, two different lengths may be set.

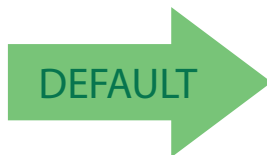

I 2 of 5 Length Control = Variable Length



I 2 of 5 Length Control = Fixed Length

I 2 of 5 Set Length 1

This feature specifies one of the bar code lengths for I 2 of 5 Length Control. Length 1 is the minimum label length if in Variable Length Mode, or the first fixed length if in Fixed Length Mode. The length includes the bar code's check and data characters. The length can be set from 2 to 50 characters in increments of two.

Table 7 provides some examples for setting Length 1. See page 241 for detailed instructions on setting this feature.

Table 7. I 2 of 5 Length 1 Setting Examples

STEP	ACTION	EXAMPLES			
1	Desired Setting	2 Characters	6 Characters	14 Characters	50 Characters
2	Pad with leading zeros to yield two digits	02	06	14	50
3	Scan ENTER/EXIT PROGRAMMING MODE				
4	Scan SELECT I 2 of 5 LENGTH 1 SETTING				
5	Scan Two Characters From Appendix D, Keypad	'0' and '2'	'0' and '6'	'1' and '4'	'5' AND '0'
6	Scan ENTER/EXIT PROGRAMMING MODE				



Select I 2 of 5 Length 1 Setting

Make a mistake? Scan the CANCEL bar code to abort and not save the entry string. You can then start again at the beginning.



CANCEL



06 = Length 1 is 6 Characters



I 2 of 5 Set Length 2

This feature specifies one of the bar code lengths for I 2 of 5 Length Control. Length 2 is the maximum label length if in Variable Length Mode, or the second fixed length if in Fixed Length Mode. The length includes the bar code's check and data characters.

The length can be set from 2 to 50 characters. A setting of 0 specifies to ignore this length (only one fixed length).

Table 8 provides examples for setting Length 2. See page 241 for detailed instructions on setting this feature.

Table 8. I 2 of 5 Length 2 Setting Examples

STEP	ACTION	EXAMPLES			
1	Desired Setting	Ignore This Length	4 Characters	14 Characters	50 Characters
2	Pad with leading zeros to yield two digits	00	04	14	50
3	Scan ENTER/EXIT PROGRAMMING MODE				
4	Scan SELECT I 2 OF 5 LENGTH 2 SETTING				
5	Scan Two Characters From Appendix D, Keypad	'0' and '0'	'0' and '4'	'1' and '4'	'5' AND '0'
6	Scan ENTER/EXIT PROGRAMMING MODE				



Select I 2 of 5 Length 2 Setting

Make a mistake? Scan the CANCEL bar code to abort and not save the entry string. You can then start again at the beginning.



CANCEL

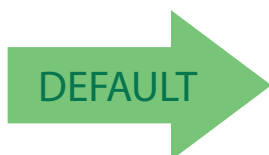

50 = Length 2 is 50 Characters



INTERLEAVED 2 OF 5 CIP HR

The following options apply to the Interleaved 2 of 5 CIP HR symbology.

Interleaved 2 of 5 CIP HR Enable/Disable

Enables/Disables ability of reader to decode Interleaved 2 of 5 CIP HR labels.

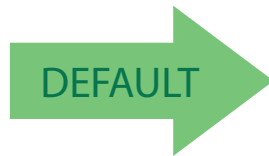

Interleaved 2 of 5 CIP HR = Disable



Interleaved 2 of 5 CIP HR = Enable

FOLLETT 2 OF 5

The following options apply to the Follett 2 of 5 symbology.

Follett 2 of 5 Enable/Disable

Enables/Disables ability of reader to decode Plessey labels.

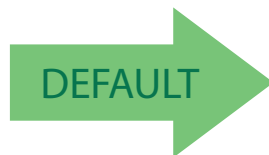

Follett 2 of 5 = Disable



Follett 2 of 5 = Enable



STANDARD 2 OF 5

The following options apply to the Standard 2 of 5 symbology.

Standard 2 of 5 Enable/Disable

When disabled, the reader will not read Standard 2 of 5 bar codes.

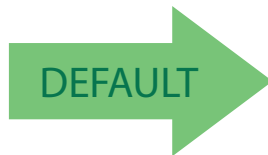

Standard 2 of 5 = Disable



Standard 2 of 5 = Enable

Standard 2 of 5 Check Character Calculation

This option enables/disables calculation and verification of an optional Standard 2 of 5 check character.



Standard 2 of 5 Check Character Calculation = Disable



Standard 2 of 5 Check Character Calculation = Enable

Standard 2 of 5 Check Character Transmission

This feature enables/disables transmission of an optional Standard 2 of 5 check character.

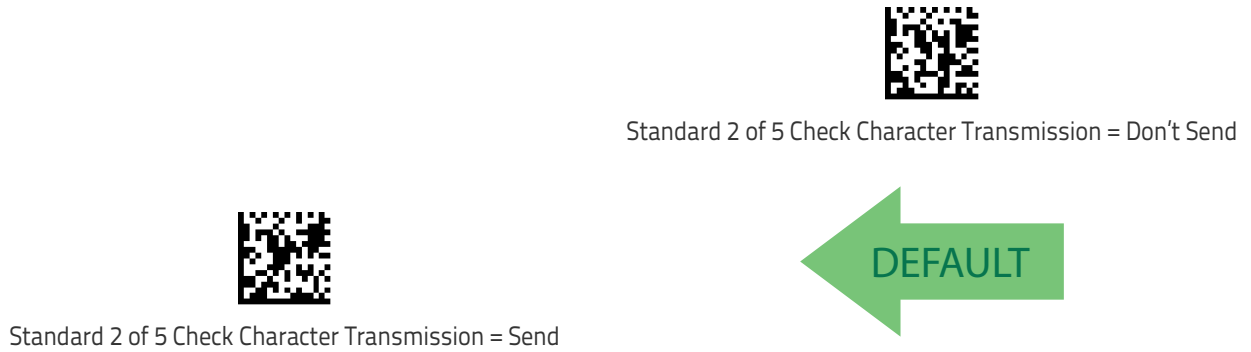

Standard 2 of 5 Length Control

This feature specifies either variable length decoding or fixed length decoding for the Standard 2 of 5 symbology.

Variable Length: For variable length decoding, a minimum and maximum length may be set.

Fixed Length: For fixed length decoding, two different lengths may be set.

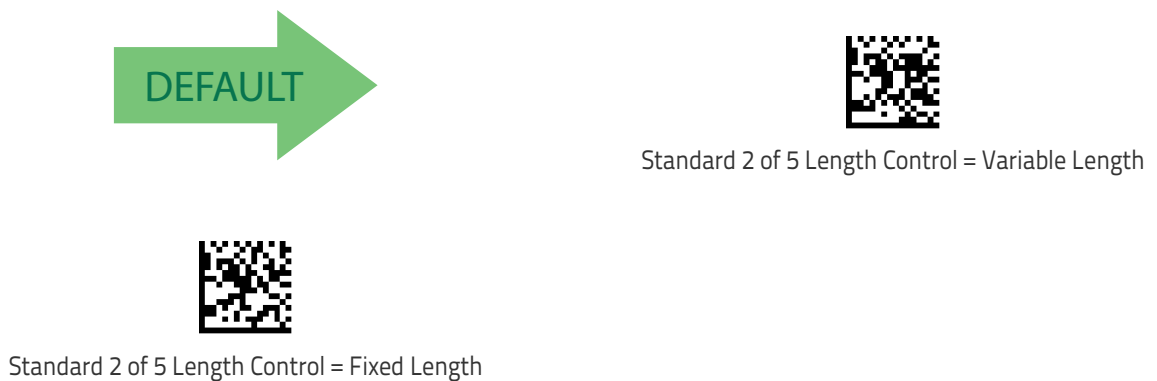



Standard 2 of 5 Set Length 1

This feature specifies one of the bar code lengths for Standard 2 of 5 Length Control. Length 1 is the minimum label length if in Variable Length Mode, or the first fixed length if in Fixed Length Mode. Length includes the bar code's check and data characters. The length can be set from 1 to 50 characters.

Table 9 provides some examples for setting Length 1. See page 241 if you want detailed instructions on setting this feature.

Table 9. Standard 2 of 5 Length 1 Setting Examples

STEP	ACTION	EXAMPLES			
1	Desired Setting	01 Character	07 Characters	15 Characters	50 Characters
2	Scan ENTER/EXIT PROGRAMMING MODE				
3	Scan SELECT STANDARD 2 OF 5 LENGTH 1 SETTING				
4	Scan Two Characters From Appendix D, Keypad	'0' and '1'	'0' and '7'	'1' and '5'	'5' AND '0'
5	Scan ENTER/EXIT PROGRAMMING MODE				



Select Standard 2 of 5 Length 1 Setting

Make a mistake? Scan the CANCEL bar code to abort and not save the entry string. You can then start again at the beginning.



CANCEL



08 = Length 1 is 8 Characters

Standard 2 of 5 Set Length 2

This feature specifies one of the bar code lengths for Standard 2 of 5 Length Control. Length 2 is the maximum label length if in Variable Length Mode, or the second fixed length if in Fixed Length Mode. Length includes the bar code's check and data characters.

The length can be set from 1 to 50 characters. A setting of 0 specifies to ignore this length (only one fixed length).

Table 10 provides examples for setting Length 2. See page 241 for detailed instructions on setting this feature.

Table 10. Standard 2 of 5 Length 2 Setting Examples

STEP	ACTION	EXAMPLES			
1	Desired Setting (pad with leading zeros)	00 (Ignore This Length)	07 Characters	15 Characters	50 Characters
2	Scan ENTER/EXIT PROGRAMMING MODE				
3	Scan SELECT STANDARD 2 OF 5 LENGTH 2 SETTING				
4	Scan Two Characters From Appendix D, Keypad	'0' and '0'	'0' and '7'	'1' and '5'	'5' AND '0'
5	Scan ENTER/EXIT PROGRAMMING MODE				



Select Standard 2 of 5 Length 2 Setting

Make a mistake? Scan the CANCEL bar code to abort and not save the entry string. You can then start again at the beginning.



CANCEL

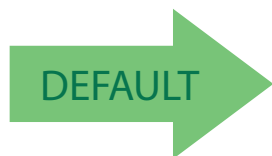

50 = Length 2 is 50 Characters



INDUSTRIAL 2 OF 5

The following options apply to the Industrial 2 of 5 symbology.

Industrial 2 of 5 Enable/Disable

Enables/Disables ability of reader to decode Industrial 2 of 5 labels.

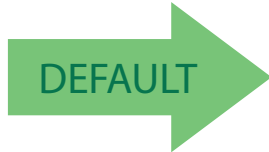

Industrial 2 of 5 = Disable



Industrial 2 of 5 = Enable

Industrial 2 of 5 Check Character Calculation

Enables/Disables calculation and verification of an optional Industrial 2 of 5 check character.

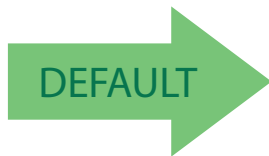

Industrial 2 of 5 Check Character Calculation = Disable



Industrial 2 of 5 Check Character Calculation = Enable

Industrial 2 of 5 Check Character Transmission

Enables/disables transmission of an Industrial 2 of 5 check character.



Industrial 2 of 5 Check Character Transmission = Disable



Industrial 2 of 5 Check Character Transmission = Enable

Industrial 2 of 5 Length Control

This feature specifies either variable length decoding or fixed length decoding for the Industrial 2 of 5 symbology.

Variable Length: For variable length decoding, a minimum and maximum length may be set.

Fixed Length: For fixed length decoding, two different lengths may be set.

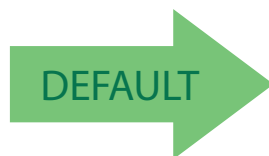

Industrial 2 of 5 Length Control = Variable Length



Industrial 2 of 5 = Fixed Length



Industrial 2 of 5 Set Length 1

This feature specifies one of the bar code lengths for Industrial 2 of 5 Length Control. Length 1 is the minimum label length if in Variable Length Mode, or the first fixed length if in Fixed Length Mode. Length includes the bar code's data characters only. The length can be set from 0 to 50 characters.

Table 11 provides some examples for setting Length 1. See page 241 if you want detailed instructions on setting this feature.

Table 11. Industrial 2 of 5 Length 1 Setting Examples

STEP	ACTION	EXAMPLES			
1	Desired Setting	00 Characters	07 Characters	15 Characters	50 Characters
2	Scan ENTER/EXIT PROGRAMMING MODE				
3	Scan SELECT INDUSTRIAL 2 OF 5 LENGTH 1 SETTING				
4	Scan Two Characters From Appendix D, Keypad	'0' and '0'	'0' and '7'	'1' and '5'	'5' AND '0'
5	Scan ENTER/EXIT PROGRAMMING MODE				



Select Industrial 2 of 5 Set Length 1 Setting

Make a mistake? Scan the CANCEL bar code to abort and not save the entry string. You can then start again at the beginning.



CANCEL

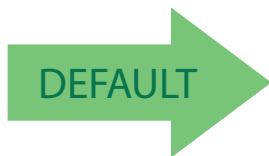

01 = Length 1 is 1 Character

Industrial 2 of 5 Set Length 2

This feature specifies one of the bar code lengths for Industrial 2 of 5 Length Control. Length 2 is the maximum label length if in Variable Length Mode, or the second fixed length if in Fixed Length Mode. Length includes the bar code's check, data, and full-ASCII shift characters. The length does not include start/stop characters.

The length can be set from 1 to 50 characters. A setting of 0 specifies to ignore this length (only one fixed length).

Table 12 provides examples for setting Length 2. See page 241 for detailed instructions on setting this feature.

Table 12. Industrial 2 of 5 Length 2 Setting Examples

STEP	ACTION	EXAMPLES			
1	Desired Setting	00 (Ignore This Length)	07 Characters	15 Characters	50 Characters
2	Scan ENTER/EXIT PROGRAMMING MODE				
3	Scan SELECT INDUSTRIAL 2 OF 5 LENGTH 2 SETTING				
4	Scan Two Characters From Appendix D, Keypad	'0' and '0'	'0' and '7'	'1' and '5'	'5' AND '0'
5	Scan ENTER/EXIT PROGRAMMING MODE				



Select Industrial 2 of 5 Length 2 Setting

Make a mistake? Scan the CANCEL bar code to abort and not save the entry string. You can then start again at the beginning.



CANCEL

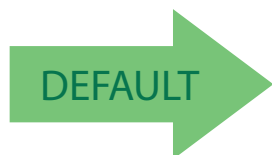

50 = Length 2 is 50 Characters



CODE IATA

The following options apply to the IATA symbology.

IATA Enable/Disable

Enables/Disables the ability of the reader to decode IATA labels.

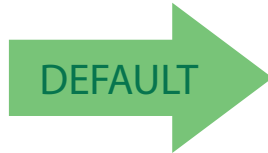

IATA = Disable



IATA = Enable

IATA Check Character Transmission

Enables/Disables calculation and verification of an optional Industrial 2 of 5 check character.



IATA Check Character Transmission = Disable



IATA Check Character Transmission = Enable



CODABAR

The following options apply to the Codabar symbology.

Codabar Enable/Disable

When disabled, the reader will not read Codabar bar codes.

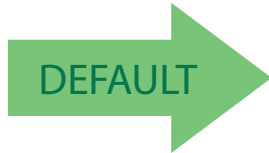

Codabar = Disable



Codabar = Enable

Codabar Check Character Calculation

Enable this option to enables/disables calculation and verification of an optional Codabar check character. When disabled, any check character in the label is treated as a data character

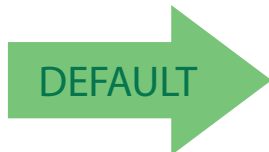

Codabar Check Character Calculation = Don't Calculate



Codabar Check Character Calculation = Enable AIM standard
check character



Codabar Check Character Calculation = Enable Modulo 10
check character



Codabar Check Character Transmission

Enable this option to transmit the check character along with Codabar bar code data.



Codabar Check Character Transmission = Don't Send



Codabar Check Character Transmission = Send



Codabar Start/Stop Character Transmission

Enable this option to enable/disable transmission of Codabar start and stop characters.



Codabar Start/Stop Character Transmission = Don't Transmit



Codabar Start/Stop Character Transmission = Transmit



Codabar Start/Stop Character Set

This option specifies the format of transmitted Codabar start/stop characters.



Codabar Check Character Set = ABCD/TN*E



Codabar Check Character Set = ABCD/ABCD



Codabar Check Character Set = abcd/tn*e



Codabar Check Character Set = abcd/abcd



Codabar Start/Stop Character Match

When enabled, this option requires that start and stop characters match.

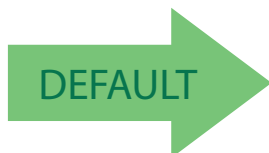

Codabar Start/Stop Character Match = Don't Require Match



Codabar Start/Stop Character Match = Require Match



Codabar Quiet Zones

Specifies the number of quiet zones for Codabar labels. Quiet zones are blank areas at the ends of a bar code and are typically 10 times the width of the narrowest bar or space in the label.



Codabar Quiet Zones = Quiet Zones on two sides



Codabar Quiet Zones = Small Quiet Zones on two sides



Codabar Length Control

This feature specifies either variable length decoding or fixed length decoding for the Codabar symbology.

Variable Length: For variable length decoding, a minimum and maximum length may be set.

Fixed Length: For fixed length decoding, two different lengths may be set.

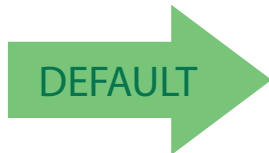

Codabar Length Control = Variable Length



Codabar Length Control = Fixed Length

Codabar Set Length 1

This feature specifies one of the bar code lengths for Codabar Length Control–Codabar Length Control. Length 1 is the minimum label length if in Variable Length Mode, or the first fixed length if in Fixed Length Mode. Length includes the bar code’s start, stop, check and data characters. The length must include at least one data character. The length can be set from 3 to 50 characters.

Table 13 provides some examples for setting Length 1. See page 241 for detailed instructions on setting this feature.

Table 13. Codabar Length 1 Setting Examples

STEP	ACTION	EXAMPLES			
1	Desired Setting (and pad with leading zeros)	03 Characters	09 Characters	15 Characters	50 Characters
2	Scan ENTER/EXIT PROGRAMMING MODE				
3	Scan SELECT CODABAR LENGTH 1 SETTING				
4	Scan Two Characters From Appendix D, Keypad	'0' and '3'	'0' and '9'	'1' and '5'	'5' AND '0'
5	Scan ENTER/EXIT PROGRAMMING MODE				



Select Codabar Length 1 Setting

Make a mistake? Scan the CANCEL bar code to abort and not save the entry string. You can then start again at the beginning.



CANCEL

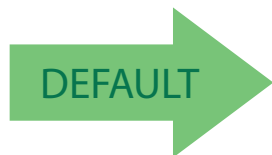

03 = Length 1 is 3 Characters



Codabar Set Length 2

This feature specifies one of the bar code lengths for Codabar Length Control–Codabar Length Control. Length 2 is the maximum label length if in Variable Length Mode, or the second fixed length if in Fixed Length Mode. The length includes the bar code’s start, stop, check and data characters. The length must include at least one data character.

The length can be set from 3 to 50 characters. A setting of 0 specifies to ignore this length (only one fixed length).

Table 14 provides examples for setting Length 2. See page 241 for detailed instructions on setting this feature.

Table 14. Codabar Length 2 Setting Examples

STEP	ACTION	EXAMPLES			
1	Desired Setting (and pad with leading zeros)	00 Ignore This Length	07 Characters	15 Characters	50 Characters
2	Scan ENTER/EXIT PROGRAMMING MODE				
3	Scan SELECT CODABAR LENGTH 2 SETTING				
4	Scan Two Characters From Appendix D, Keypad	'0' and '0'	'0' and '7'	'1' and '5'	'5' AND '0'
5	Scan ENTER/EXIT PROGRAMMING MODE				



Select Codabar Length 2 Setting

Make a mistake? Scan the CANCEL bar code to abort and not save the entry string. You can then start again at the beginning.



CANCEL

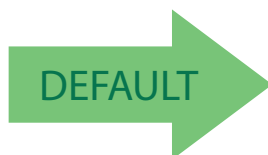

50 = Length 2 is 50 Characters

ABC CODABAR

The following options apply to the ABC Codabar symbology.

ABC Codabar Enable/Disable

Enables/Disables ability of reader to decode ABC Codabar labels.

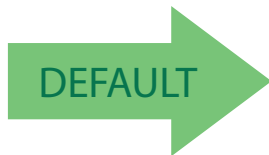

ABC Codabar = Disable



ABC Codabar = Enable

ABC Codabar Concatenation Mode

Specifies the concatenation mode between Static and Dynamic.

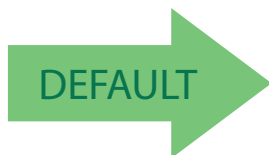

ABC Codabar Concatenation Mode = Static



ABC Codabar Concatenation Mode = Dynamic



ABC Codabar Dynamic Concatenation Timeout

Specifies the timeout in 10-millisecond ticks used by the ABC Codabar Dynamic Concatenation Mode.



ABC Codabar Dynamic Concatenation Timeout = 50 msec



ABC Codabar Dynamic Concatenation Timeout = 100 msec

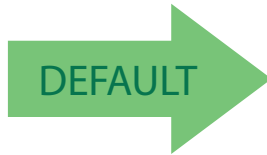

ABC Codabar Dynamic Concatenation Timeout = 200 msec



ABC Codabar Dynamic Concatenation Timeout = 500 msec



ABC Codabar Dynamic Concatenation Timeout = 750 msec



ABC Codabar Dynamic Concatenation Timeout = 1 Second

ABC Codabar Force Concatenation

Forces labels starting or ending with D to be concatenated.

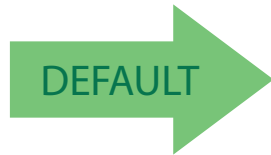

ABC Codabar Force Concatenation = Disable



ABC Codabar Force Concatenation = Enable



CODE 11

The following options apply to the Code 11 symbology.

Code 11 Enable/Disable

When disabled, the reader will not read Code 11 bar codes.

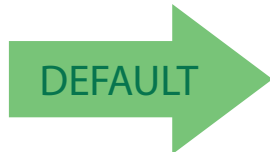

Code 11 = Disable



Code 11 = Enable

Code 11 Check Character Calculation

This option enables/disables calculation and verification of optional Code 11 check character.



Code 11 Check Character Calculation = Disable



Code 11 Check Character Calculation = Check C



Code 11 Check Character Calculation = Check K



Code 11 Check Character Calculation = Check C and K



Code 11 Check Character Transmission

This feature enables/disables transmission of an optional Code 11 check character.

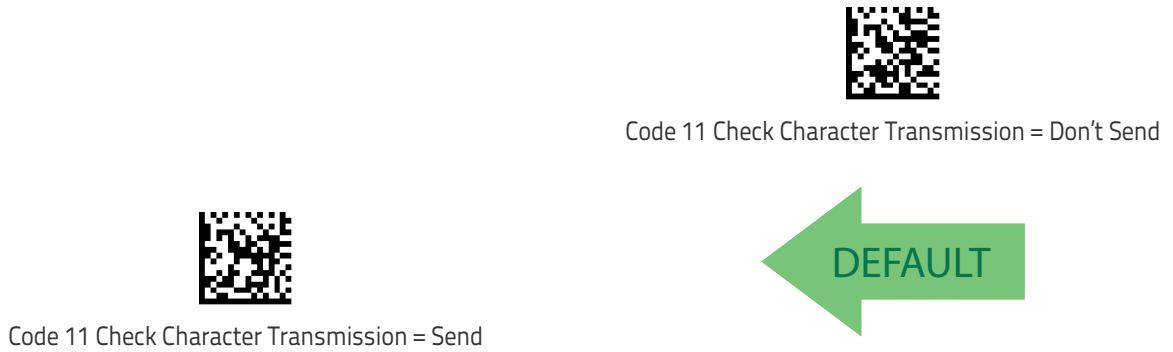

Code 11 Length Control

This feature specifies either variable length decoding or fixed length decoding for the Code 11 symbology.

Variable Length: For variable length decoding, a minimum and maximum length may be set.

Fixed Length: For fixed length decoding, two different lengths may be set.

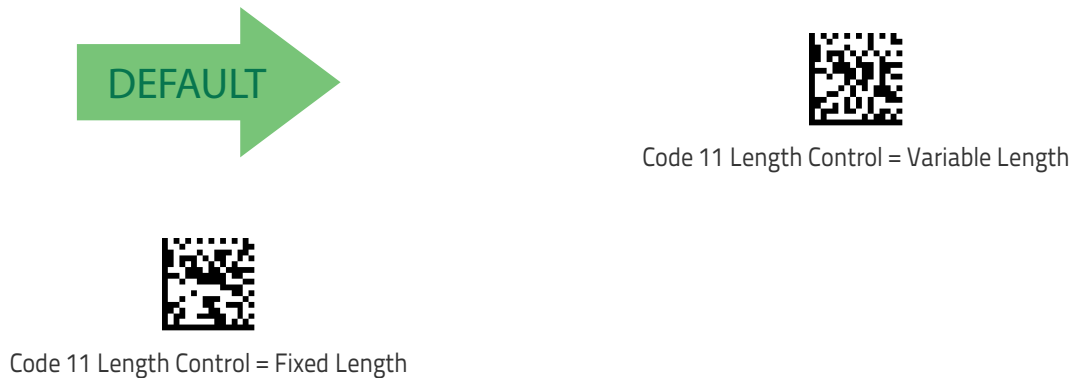



Code 11 Set Length 1

This feature specifies one of the bar code lengths for Code 11 Length Control. Length 1 is the minimum label length if in Variable Length Mode, or the first fixed length if in Fixed Length Mode. Length includes the bar code’s check and data characters. The length can be set from 2 to 50 characters.

Table 15 provides some examples for setting Length 1. See page 241 for detailed instructions on setting this feature.

Table 15. Code 11 Length 1 Setting Examples

STEP	ACTION	EXAMPLES			
1	Desired Setting (pad with leading zeros)	02 Characters	07 Characters	15 Characters	50 Characters
2	Scan ENTER/EXIT PROGRAMMING MODE				
3	Scan SELECT CODE 11 LENGTH 1 SETTING				
4	Scan Two Characters From Appendix D, Keypad	'0' and '2'	'0' and '7'	'1' and '5'	'5' AND '0'
5	Scan ENTER/EXIT PROGRAMMING MODE				



Select Code 11 Set Length 1 Setting

Make a mistake? Scan the CANCEL bar code to abort and not save the entry string. You can then start again at the beginning.



CANCEL

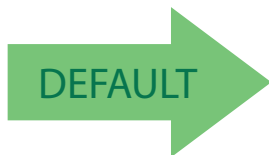

04 = Length 1 is 4 Characters

Code 11 Set Length 2

This feature specifies one of the bar code lengths for Code 11 Length Control. Length 2 is the maximum label length if in Variable Length Mode, or the second fixed length if in Fixed Length Mode. Length includes the bar code's check and data characters.

The length can be set from 2 to 50 characters. A setting of 0 specifies to ignore this length (only one fixed length).

Table 16 provides examples for setting Length 2. See page 241 for detailed instructions on setting this feature.

Table 16. Code 11 Length 2 Setting Examples

STEP	ACTION	EXAMPLES			
1	Desired Setting (pad with leading zeros)	00 (Ignore This Length)	07 Characters	15 Characters	50 Characters
2	Scan ENTER/EXIT PROGRAMMING MODE				
3	Scan SELECT CODE 11 LENGTH 2 SETTING				
4	Scan Two Characters From Appendix D, Keypad	'0' and '0'	'0' and '7'	'1' and '5'	'5' and '0'
5	Scan ENTER/EXIT PROGRAMMING MODE				



Select Code 11 Length 2 Setting

Make a mistake? Scan the CANCEL bar code to abort and not save the entry string. You can then start again at the beginning.



CANCEL

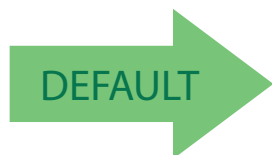

50 = Length 2 is 50 Characters



GS1 DATABAR™ OMNIDIRECTIONAL

The following options apply to the GS1 DataBar™ Omnidirectional (formerly RSS-14) symbology.

GS1 DataBar™ Omnidirectional Enable/Disable

When disabled, the reader will not read GS1 DataBar™ Omnidirectional bar codes.

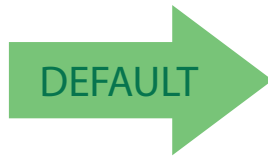

GS1 DataBar™ Omnidirectional = Disable



GS1 DataBar™ Omnidirectional = Enable

GS1 DataBar™ Omnidirectional GS1-128 Emulation

When enabled, GS1 DataBar™ Omnidirectional bar codes will be translated to the GS1-128 label data format.

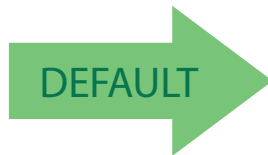

GS1 DataBar™ Omnidirectional GS1-128 Emulation = Disable



GS1 DataBar™ Omnidirectional GS1-128 Emulation = Enable

GS1 DataBar™ Omnidirectional 2D Component

This feature enables/disables a requirement that a 2D label component be decoded when a base label for this symbology is decoded.

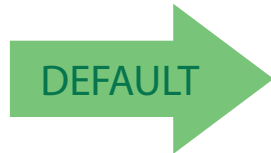

GS1 DataBar™ Omnidirectional 2D Component =
Disable (2D component not required)



GS1 DataBar™ Omnidirectional 2D Component =
2D component must be decoded

GS1 DATABAR™ EXPANDED

The following options apply to the GS1 DataBar™ Expanded (formerly RSS Expanded) symbology.

GS1 DataBar™ Expanded Enable/Disable

When disabled, the reader will not read GS1 DataBar™ Expanded bar codes.

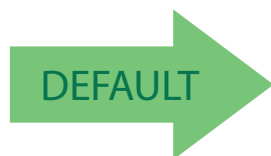

GS1 DataBar™ Expanded = Disable



GS1 DataBar™ Expanded = Enable



GS1 DataBar™ Expanded GS1-128 Emulation

When enabled, GS1 DataBar™ Expanded bar codes will be translated to the GS1-128 label data format.

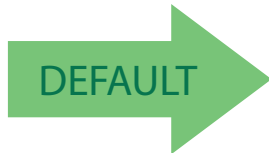

GS1 DataBar™ Expanded GS1-128 Emulation = Disable



GS1 DataBar™ Expanded GS1-128 Emulation = Enable

GS1 DataBar™ Expanded 2D Component

This feature enables/disables a requirement that a 2D label component be decoded when a base label of this symbology is decoded.

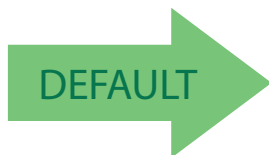

GS1 DataBar™ Expanded 2D Component = Disable



GS1 DataBar™ Expanded 2D Component = Enable

GS1 DataBar™ Expanded Length Control

This feature specifies either variable length decoding or fixed length decoding for the GS1 DataBar™ Expanded symbology.

Variable Length: For variable-length decoding, a minimum length may be set.

Fixed Length: For fixed-length decoding, two different lengths may be set.

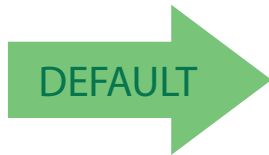

GS1 DataBar™ Expanded Length Control = Variable Length



GS1 DataBar™ Expanded Length Control = Fixed Length



GS1 DataBar™ Expanded Set Length 1

This feature specifies one of the bar code lengths for GS1 DataBar™ Expanded Length Control. Length 1 is the minimum label length if in Variable Length Mode, or the first fixed length if in Fixed Length Mode. Length includes the bar code’s data characters only. The length can be set from 1 to 74 characters.

Table 17 provides some examples for setting Length 1. See page 241 for detailed instructions on setting this feature.

Table 17. GS1 DataBar™ Expanded Length 1 Setting Examples

STEP	ACTION	EXAMPLES			
1	Desired Setting	01 Character	07 Characters	52 Characters	74 Characters
2	Scan ENTER/EXIT PROGRAMMING MODE				
3	Scan SELECT GS1 DataBar™ EXPANDED LENGTH 1SETTING				
4	Scan Two Characters From Appendix D, Keypad	'0' and '1'	'0' and '7'	'5' and '2'	'7' AND '4'
5	Scan ENTER/EXIT PROGRAMMING MODE				



Select GS1 DataBar™ Expanded Set Length 1 Setting

Make a mistake? Scan the CANCEL bar code to abort and not save the entry string. You can then start again at the beginning.



CANCEL

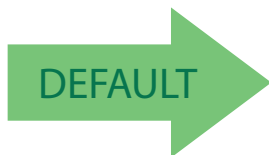

01 = Length 1 is 1 Character

GS1 DataBar™ Expanded Set Length 2

This feature specifies one of the bar code lengths for GS1 DataBar™ Expanded Length Control. Length 2 is the maximum label length if in Variable Length Mode, or the second fixed length if in Fixed Length Mode. Length includes the bar code’s data characters only. The length can be set from 1 to 74 characters. A setting of 0 specifies to ignore this length (only one fixed length).

Table 18 provides examples for setting Length 2. See page 241 for detailed instructions on setting this feature.

Table 18. GS1 DataBar™ Expanded Length 2 Setting Examples

STEP	ACTION	EXAMPLES			
1	Desired Setting	00 (ignore second length)	07 Characters	52 Characters	74 Characters
2	Scan ENTER/EXIT PROGRAMMING MODE				
3	Scan SELECT GS1 DataBar™ EXPANDED LENGTH 2 SETTING				
4	Scan Two Characters From Appendix D, Keypad	'0' and '0'	'0' and '7'	'5' and '2'	'7' and '4'
5	Scan ENTER/EXIT PROGRAMMING MODE				



Select GS1 DataBar™ Expanded Set Length 2 Setting

Make a mistake? Scan the CANCEL bar code to abort and not save the entry string. You can then start again at the beginning.



CANCEL

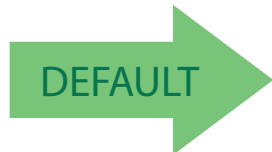

74 = Length 2 is 74 Characters



GS1 DATABAR™ LIMITED

The following options apply to the GS1 DataBar™ Limited (formerly RSS Limited) symbology.

GS1 DataBar™ Limited Enable/Disable

When disabled, the reader will not read GS1 DataBar™ Limited bar codes.

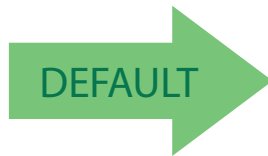

GS1 DataBar™ Limited = Disable



GS1 DataBar™ Limited = Enable

GS1 DataBar™ Limited GS1-128 Emulation

When enabled, GS1 DataBar™ Limited bar codes will be translated to the GS1-128 label data format.

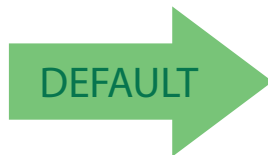

GS1 DataBar™ Limited GS1-128 Emulation = Disable



GS1 DataBar™ Limited GS1-128 Emulation = Enable



GS1 DataBar™ Limited 2D Component

This feature enables/disables a requirement that a 2D label component be decoded when a base label of this symbology is decoded.

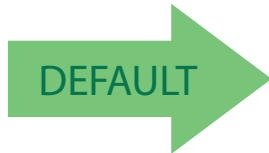

GS1 DataBar™ Limited 2D Component =
Disable (2D component not required)



GS1 DataBar™ Limited 2D Component =
2D component must be decoded

CODE 93

The following options apply to the Code 93 symbology.

Code 93 Enable/Disable

Enables/Disables ability of reader to decode Code 93 labels.

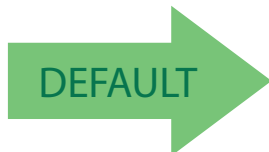

Code 93 = Disable



Code 93 = Enable



Code 93 Check Character Calculation

Enables/disables calculation and verification of an optional Code 93 check character.



Code 93 Check Character Calculation = Disable



Code 93 Check Character Calculation = Enable Check C



Code 93 Check Character Calculation = Enable Check K



Code 93 Check Character Calculation = Enable Check C and K



Code 93 Check Character Transmission

Enables/disables transmission of an optional Code 93 check character.



Code 93 Check Character Transmission = Disable



Code 93 Check Character Transmission = Enable



Code 93 Length Control

This feature specifies either variable length decoding or fixed length decoding for the Code 93 symbology.

Variable Length: For variable length decoding, a minimum and maximum length may be set.

Fixed Length: For fixed length decoding, two different lengths may be set.

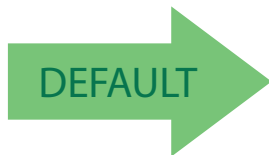

Code 93 Length Control = Variable Length



Code 93 = Fixed Length



Code 93 Set Length 1

Specifies one of the bar code lengths for Code 93 Length Control. Length 1 is the minimum label length if in Variable Length Mode, or the first fixed length if in Fixed Length Mode. Length includes the bar code’s data characters only. The length can be set from 01 to 50 characters.

Table 19 provides some examples for setting Length 1. See page 241 for detailed instructions on setting this feature.

Table 19. Code 93 Length 1 Setting Examples

STEP	ACTION	EXAMPLES			
1	Desired Setting	01 Characters	07 Characters	15 Characters	50 Characters
2	Scan ENTER/EXIT PROGRAMMING MODE				
3	Scan SELECT CODE 93 LENGTH 1 SETTING				
4	Scan Two Characters From Appendix D, Keypad	'0' and '1'	'0' and '7'	'1' and '5'	'5' AND '0'
5	Scan ENTER/EXIT PROGRAMMING MODE				



Select Code 93 Set Length 1 Setting

Make a mistake? Scan the CANCEL bar code to abort and not save the entry string. You can then start again at the beginning.



CANCEL

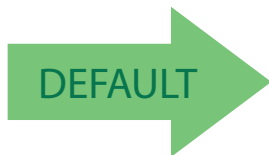

01 = Length 1 is 1 Character

Code 93 Set Length 2

This feature specifies one of the bar code lengths for Code 93 Length Control. Length 2 is the maximum label length if in Variable Length Mode, or the second fixed length if in Fixed Length Mode. Length includes the bar code’s check, data, and full-ASCII shift characters. The length does not include start/stop characters. The length can be set from 1 to 50 characters. A setting of 0 specifies to ignore this length (only one fixed length).

Table 20 provides examples for setting Length 2. See page 241 for detailed instructions on setting this feature.

Table 20. CODE 93 Length 2 Setting Examples

STEP	ACTION	EXAMPLES			
1	Desired Setting	00 (Ignore This Length)	07 Characters	15 Characters	50 Characters
2	Scan ENTER/EXIT PROGRAMMING MODE				
3	Scan SELECT CODE 93 LENGTH 2 SETTING				
4	Scan Two Characters From Appendix D, Keypad	'0' and '0'	'0' and '7'	'1' and '5'	'5' AND '0'
5	Scan ENTER/EXIT PROGRAMMING MODE				



Select Code 93 Length 2 Setting

Make a mistake? Scan the CANCEL bar code to abort and not save the entry string. You can then start again at the beginning.



CANCEL

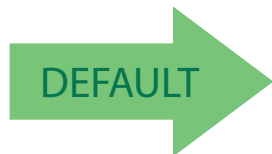

50 = Length 2 is 50 Characters



Code 93 Quiet Zones

Enables/disables quiet zones for Code 93.



Code 93 Quiet Zones = Quiet Zones on two sides



Code 93 Quiet Zones = Small Quiet Zones on two sides



MSI

The following options apply to the MSI symbology.

MSI Enable/Disable

Enables/Disables ability of reader to decode MSI labels.

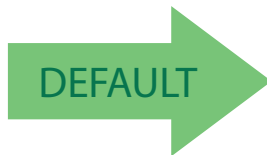

MSI = Disable



MSI = Enable



MSI Check Character Calculation

Enables/Disables calculation and verification of an optional MSI check character.

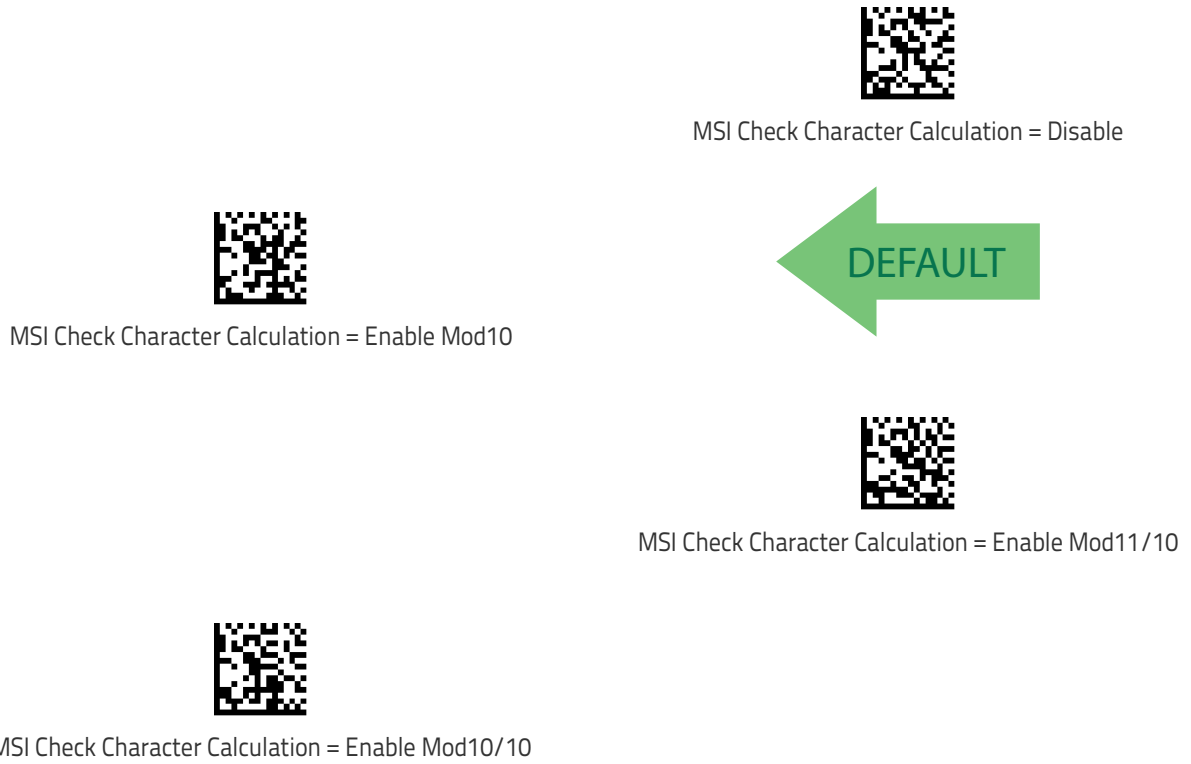

MSI Check Character Transmission

Enables/disables transmission of an MSI check character.

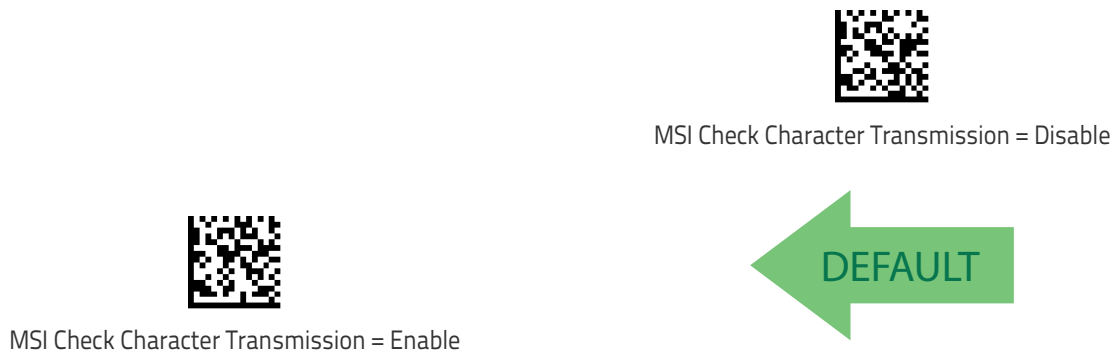



MSI Length Control

This feature specifies either variable length decoding or fixed length decoding for the MSI symbology.

Variable Length: For variable length decoding, a minimum and maximum length may be set.

Fixed Length: For fixed length decoding, two different lengths may be set.

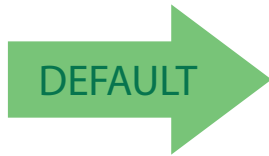

MSI Length Control = Variable Length



MSI = Fixed Length

MSI Set Length 1

This feature specifies one of the bar code lengths for MSI Length Control. Length 1 is the minimum label length if in *Variable Length Mode*, or the first fixed length if in *Fixed Length Mode*. Length includes the bar code’s data characters only. The length can be set from 01 to 50 characters.

Table 21 provides some examples for setting Length 1. See page 241 for detailed instructions on setting this feature.

Table 21. MSI Length 1 Setting Examples

STEP	ACTION	EXAMPLES			
1	Desired Setting	01 Characters	07 Characters	15 Characters	50 Characters
2	Scan ENTER/EXIT PROGRAMMING MODE				
3	Scan SELECT MSI LENGTH 1 SETTING				
4	Scan Two Characters From Appendix D, Keypad	'0' and '1'	'0' and '7'	'1' and '5'	'5' AND '0'
5	Scan ENTER/EXIT PROGRAMMING MODE				



Select MSI Set Length 1 Setting

Make a mistake? Scan the CANCEL bar code to abort and not save the entry string. You can then start again at the beginning.



CANCEL

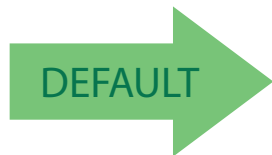

01 = Length 1 is 1 Character



MSI Set Length 2

This feature specifies one of the bar code lengths for MSI Length Control. Length 2 is the maximum label length if in Variable Length Mode, or the second fixed length if in Fixed Length Mode. Length includes the bar code’s check, data, and full-ASCII shift characters. The length does not include start/stop characters.

The length can be set from 1 to 50 characters. A setting of 0 specifies to ignore this length (only one fixed length).

Table 22 provides examples for setting Length 2. See page 241 for detailed instructions on setting this feature.

Table 22. MSI Length 2 Setting Examples

STEP	ACTION	EXAMPLES			
1	Desired Setting	00 (Ignore This Length)	07 Characters	15 Characters	50 Characters
2	Scan ENTER/EXIT PROGRAMMING MODE				
3	Scan SELECT MSI LENGTH 2 SETTING				
4	Scan Two Characters From Appendix D, Keypad	'0' and '0'	'0' and '7'	'1' and '5'	'5' AND '0'
5	Scan ENTER/EXIT PROGRAMMING MODE				



Select MSI Length 2 Setting

Make a mistake? Scan the CANCEL bar code to abort and not save the entry string. You can then start again at the beginning.



CANCEL

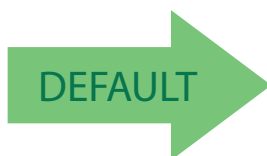

50 = Length 2 is 50 Characters

PLESSEY

The following options apply to the Plessey symbology.

Plessey Enable/Disable

Enables/Disables ability of reader to decode Plessey labels.

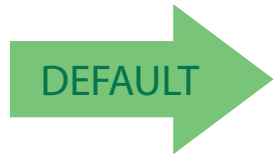

Plessey = Disable



Plessey = Enable

Plessey Check Character Calculation

Enables/Disables calculation and verification of an optional Plessey check character.



Plessey Check Character Calculation = Disable



Plessey Check Character Calculation =
Enable Plessey std. check char. verification



Plessey Check Character Calculation =
Enable Anker check char. verification



Plessey Check Character Calculation =
Enable Plessey std. and Anker check char verification



Plessey Check Character Transmission

Enables/disables transmission of an MSI check character.



Plessey Check Character Transmission = Disable



Plessey Check Character Transmission = Enable

Plessey Length Control

This feature specifies either variable length decoding or fixed length decoding for the Plessey symbology.

Variable Length: For variable length decoding, a minimum and maximum length may be set.

Fixed Length: For fixed length decoding, two different lengths may be set.

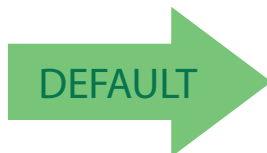

Plessey Length Control = Variable Length



Plessey = Fixed Length

Plessey Set Length 1

This feature specifies one of the bar code lengths for Plessey Length Control. Length 1 is the minimum label length if in Variable Length Mode, or the first fixed length if in Fixed Length Mode. Length includes the bar code’s data characters only. The length can be set from 01 to 50 characters.

Table 23 provides some examples for setting Length 1. See page 241 for detailed instructions on setting this feature.

Table 23. Plessey Length 1 Setting Examples

STEP	ACTION	EXAMPLES			
1	Desired Setting	01 Characters	07 Characters	15 Characters	50 Characters
2	Scan ENTER/EXIT PROGRAMMING MODE				
3	Scan SELECT Plessey LENGTH 1 SETTING				
4	Scan Two Characters From Appendix D, Keypad	'0' and '1'	'0' and '7'	'1' and '5'	'5' AND '0'
5	Scan ENTER/EXIT PROGRAMMING MODE				



Select Plessey Set Length 1 Setting

Make a mistake? Scan the CANCEL bar code to abort and not save the entry string. You can then start again at the beginning.



CANCEL

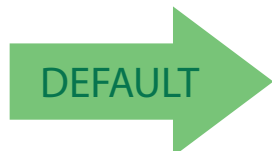

01 = Length 1 is 1 Character



Plessey Set Length 2

This feature specifies one of the bar code lengths for Plessey Length Control. Length 2 is the maximum label length if in Variable Length Mode, or the second fixed length if in Fixed Length Mode. Length includes the bar code’s check, data, and full-ASCII shift characters. The length does not include start/stop characters.

The length can be set from 1 to 50 characters. A setting of 0 specifies to ignore this length (only one fixed length).

Table 24 provides examples for setting Length 2. See page 241 for detailed instructions on setting this feature.

Table 24. Plessey Length 2 Setting Examples

STEP	ACTION	EXAMPLES			
1	Desired Setting	00 (Ignore This Length)	07 Characters	15 Characters	50 Characters
2	Scan ENTER/EXIT PROGRAMMING MODE				
3	Scan SELECT PLESSEY LENGTH 2 SETTING				
4	Scan Two Characters From Appendix D, Keypad	'0' and '0'	'0' and '7'	'1' and '5'	'5' AND '0'
5	Scan ENTER/EXIT PROGRAMMING MODE				



Select Plessey Length 2 Setting

Make a mistake? Scan the CANCEL bar code to abort and not save the entry string. You can then start again at the beginning.



CANCEL

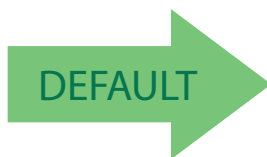

50 = Length 2 is 50 Characters

2D SYMBOLOGIES

2D Global Features

▪ 2D Maximum Decoding Time on page 172	▪ 2D Normal/Inverse Symbol Control on page 174
▪ 2D Structured Append on page 173	

2D Symbologies

The reader supports the following 2D symbologies (bar code types). Symbology-dependent options for each symbology are included in this chapter. See "1D Code Selection" starting on page 79 for configuration of 1D bar codes.

▪ Aztec Code on page 175	▪ Micro PDF417 on page 190
▪ China Sensible Code on page 178	▪ QR Code on page 193
▪ Data Matrix on page 181	▪ Micro QR Code on page 196
▪ Maxicode on page 184	▪ UCC Composite on page 199
▪ PDF417 on page 187	▪ Postal Code Selection on page 201



To enable the reader for Negative Image 2D bar codes, see Decode Negative Image on page 76.

2D Global Features

The following features are common to most of the available 2D symbologies. Default settings are indicated with a green arrow. Also reference Appendix B, Standard Defaults for a listing of the most widely used set of standard factory settings.

To set most features:

1. Scan the ENTER/EXIT PROGRAMMING bar code at the top of applicable programming pages.
2. Scan the correct bar code to set the desired programming feature or parameter. You may need to cover unused bar codes on the page, and possibly the facing page, to ensure that the reader reads only the bar code you intend to scan.
3. If additional input parameters are needed, go to Appendix D, Keypad, and scan the appropriate characters from the keypad.



Additional information about many features can be found in the "References" chapter.

If you make a mistake before the last character, scan the CANCEL bar code to abort and not save the entry string. You can then start again at the beginning.

Complete the programming sequence by scanning the ENTER/EXIT PROGRAMMING bar code to exit Programming Mode.



2D Maximum Decoding Time

This feature specifies the maximum amount of time the software will spend attempting to decode a 2D label. The selectable range is 10 milliseconds to 2.55 milliseconds.



2D Maximum Decoding Time = 100 msec



2D Maximum Decoding Time = 200 msec



2D Maximum Decoding Time = 350 msec



2D Maximum Decoding Time = 500 msec



2D Maximum Decoding Time = 1 Second



2D Maximum Decoding Time = 2 Seconds



2D Maximum Decoding Time = 2.55 Seconds

2D Structured Append

Enables/disables ability of reader to append multiple 2D Codes labels in a structured format. The structured append property is globally applied to the following symbologies, if these are enabled:

- Data Matrix
- QR Code
- Aztec
- PDF 417

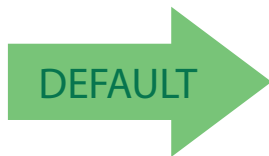

Structured Append = Disable



Structured Append = Enable



2D Normal/Inverse Symbol Control

Specifies the options available for decoding normal/negative printed 2D symbols. This configuration item applies globally to all the 2D symbologies that support that feature according to Standard AIM Specification: Data Matrix, QR, MicroQR, Aztec and Chinese Sensible Code.

To decode all symbologies, including linear symbologies, refer to "[Decode Negative Image](#)" on page 76.

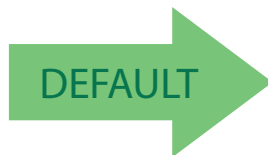

Normal/Inverse Symbol Control = Normal



Normal/Inverse Symbol Control = Inverse



Normal/Inverse Symbol Control =
Both Normal and Inverse

AZTEC CODE

Aztec Code Enable / Disable

Enables/disables the ability of the reader to decode Aztec Code labels.



Aztec Code = Enable



Aztec Code = Disable



Aztec Code Length Control

This feature specifies either variable length decoding or fixed length decoding for this symbology.

Variable Length: For variable length decoding, a minimum and maximum length may be set.

Fixed Length: For fixed length decoding, two different lengths may be set.



Aztec Code Length Control = Variable Length



Aztec Code Length Control = Fixed Length



Aztec Code Set Length 1

Specifies one of the bar code lengths for Aztec Code Length Control. Length 1 is the minimum label length if in Variable Length Mode, or the first fixed length if in Fixed Length Mode. Characters can be set from 0001 to 3,832 characters in increments of 0001 (pad with zeros).

See [page 241](#) for detailed instructions on setting this feature.



Select Aztec Code Length 1 Setting

To configure this feature, scan the ENTER/EXIT PROGRAMMING MODE bar code above, then the bar code at left followed by the digits from the Alphanumeric characters in [Appendix D, Keypad](#) representing your desired character(s). End by scanning the ENTER/EXIT bar code again.

Make a mistake? Scan the CANCEL bar code to abort and not save the entry string. You can then start again at the beginning.



CANCEL



0001 = Length 1 is 1 Character

Aztec Code Set Length 2

This feature specifies one of the bar code lengths for [Aztec Code Length Control](#). Length 2 is the maximum label length if in Variable Length Mode, or the second fixed length if in Fixed Length Mode. Characters can be set from 0001 to 3,832 characters in increments of 0001 (pad with zeros).

See [page 241](#) for detailed instructions on setting this feature.



Select Aztec Code Length 2 Setting

To configure this feature, scan the ENTER/EXIT PROGRAMMING MODE bar code above, then the bar code at left followed by the digits from the [Alphanumeric Keypad](#) representing your desired character(s). End by scanning the ENTER/EXIT bar code again.

Make a mistake? Scan the CANCEL bar code to abort and not save the entry string. You can then start again at the beginning.



CANCEL



Length 2 is 3,832 Characters



CHINA SENSIBLE CODE

China Sensible Code Enable / Disable

Enables/disables the ability of the reader to decode China Sensible Code labels.

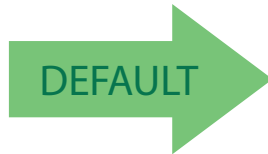

China Sensible Code = Disable



China Sensible Code = Enable

China Sensible Code Length Control

This feature specifies either variable length decoding or fixed length decoding for this symbology.

Variable Length: For variable length decoding, a minimum and maximum length may be set.

Fixed Length: For fixed length decoding, two different lengths may be set.

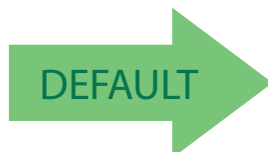

China Sensible Code Length Control = Variable Length



China Sensible Code Length Control = Fixed Length

China Sensible Code Set Length 1

Specifies one of the bar code lengths for China Sensible Code Length Control. Length 1 is the minimum label length if in Variable Length Mode, or the first fixed length if in Fixed Length Mode. Characters can be set from 0001 to 7,827 characters in increments of 0001 (pad with zeros).

See [page 241](#) for detailed instructions on setting this feature.



Select China Sensible Code Length 1 Setting

To configure this feature, scan the ENTER/EXIT PROGRAMMING MODE bar code above, then the bar code at left followed by the digits from the Alphanumeric keypad representing your desired character(s). End by scanning the ENTER/EXIT bar code again.

Make a mistake? Scan the CANCEL bar code to abort and not save the entry string. You can then start again at the beginning.



CANCEL

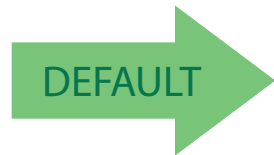

0001 = Length 1 is 1 Character



China Sensible Code Set Length 2

This feature specifies one of the bar code lengths for [China Sensible Code Length Control](#). Length 2 is the maximum label length if in Variable Length Mode, or the second fixed length if in Fixed Length Mode. Characters can be set from 0001 to 7,827 characters in increments of 0001 (pad with zeros). See [page 241](#) for detailed instructions on setting this feature.



Select China Sensible Code Length 2 Setting

To configure this feature, scan the ENTER/EXIT PROGRAMMING MODE bar code above, then the bar code at left followed by the digits from the Alphanumeric characters in [Appendix D, Keypad](#) representing your desired character(s). End by scanning the ENTER/EXIT bar code again.

Make a mistake? Scan the CANCEL bar code to abort and not save the entry string. You can then start again at the beginning.



CANCEL

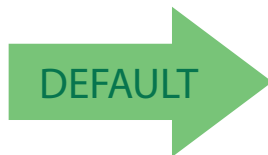

Length 2 is 7,827 Characters

DATA MATRIX

Data Matrix Enable / Disable

Enables/disables ability of reader to decode Data Matrix labels.



Data Matrix Square/Rectangular Style

Specifies the options available when reading Data Matrix with different form factors. Choices are:

- Square Style
- Rectangular Style
- Both Square and Rectangular Style

The configuration item can also be configured as a bit mask to filter one or more Data Matrix labels with different symbol size AND shape styles.

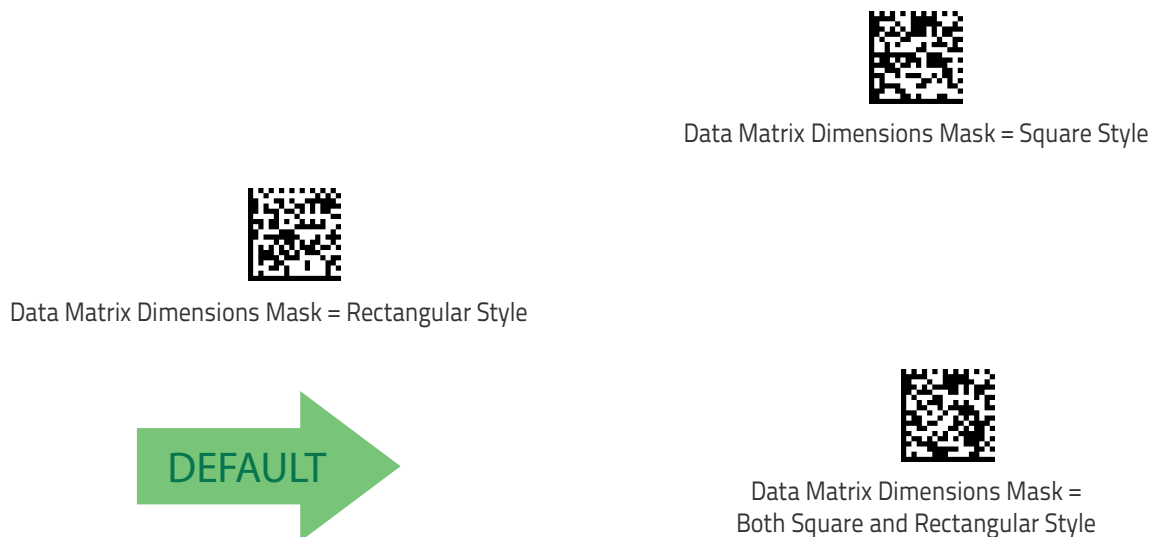



Data Matrix Length Control

This feature specifies either variable length decoding or fixed length decoding for this symbology.

Variable Length: For variable length decoding, a minimum and maximum length may be set.

Fixed Length: For fixed length decoding, two different lengths may be set.

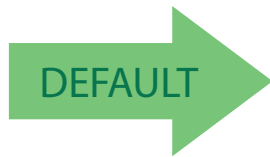

Data Matrix Length Control = Variable Length



Data Matrix Length Control = Fixed Length

Data Matrix Set Length 1

Specifies one of the bar code lengths for [Data Matrix Length Control](#). Length 1 is the minimum label length if in Variable Length Mode, or the first fixed length if in Fixed Length Mode. Characters can be set from 0001 to 3,116 characters in increments of 0001 (pad with zeros).

See [page 241](#) for detailed instructions on setting this feature.



Select Data Matrix Length 1 Setting

To configure this feature, scan the ENTER/EXIT PROGRAMMING MODE bar code above, then the bar code at left followed by the digits from the Alphanumeric characters in [Appendix D, Keypad](#) representing your desired character(s). End by scanning the ENTER/EXIT bar code again.

Make a mistake? Scan the CANCEL bar code to abort and not save the entry string. You can then start again at the beginning.



CANCEL

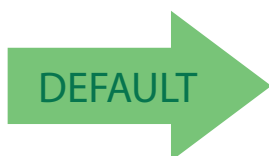

0001 = Length 1 is 1 Character

Data Matrix Set Length 2

This feature specifies one of the bar code lengths for [Data Matrix Length Control](#). Length 2 is the maximum label length if in Variable Length Mode, or the second fixed length if in Fixed Length Mode. Characters can be set from 0001 to 3,116 characters in increments of 0001 (pad with zeros).

See [page 241](#) for detailed instructions on setting this feature.



Select Data Matrix Length 2 Setting

To configure this feature, scan the ENTER/EXIT PROGRAMMING MODE bar code above, then the bar code at left followed by the digits from the Alphanumeric characters in [Appendix D, Keypad](#) representing your desired character(s). End by scanning the ENTER/EXIT bar code again.

Make a mistake? Scan the CANCEL bar code to abort and not save the entry string. You can then start again at the beginning.



CANCEL

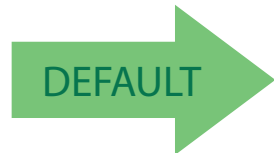

Length 2 is 3,116 Characters



MAXICODE

Maxicode Enable / Disable

Enables/disables ability of reader to decode Maxicode labels.

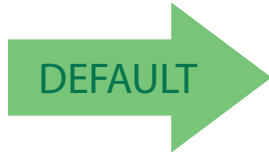

Maxicode = Disable



Maxicode = Enable

Maxicode Primary Message Transmission

Enables/disables the transmission of only the Primary Message when the Secondary Message is not readable.

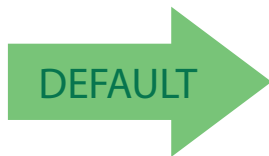

Maxicode Primary Message Transmission = Disable



Maxicode Primary Message Transmission = Enable

Maxicode Length Control

This feature specifies either variable length decoding or fixed length decoding for this symbology.

Variable Length: For variable length decoding, a minimum and maximum length may be set.

Fixed Length: For fixed length decoding, two different lengths may be set.

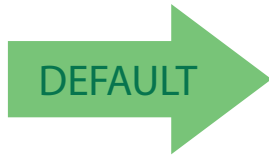

Maxicode Length Control = Variable Length



Maxicode Length Control = Fixed Length

Maxicode Set Length 1

Specifies one of the bar code lengths for **Maxicode Length Control**. Length 1 is the minimum label length if in Variable Length Mode, or the first fixed length if in Fixed Length Mode. Characters can be set from 0001 to 0145 characters in increments of 0001 (pad with zeros).

See [page 241](#) for detailed instructions on setting this feature.



Select Maxicode Length 1 Setting

To configure this feature, scan the ENTER/EXIT PROGRAMMING MODE bar code above, then the bar code at left followed by the digits from the Alphanumeric characters in [Appendix D, Keypad](#) representing your desired character(s). End by scanning the ENTER/EXIT bar code again.

Make a mistake? Scan the CANCEL bar code to abort and not save the entry string. You can then start again at the beginning.



CANCEL

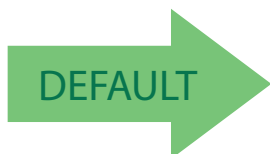

0001 = Length 1 is 1 Character



Maxicode Set Length 2

This feature specifies one of the bar code lengths for Maxicode Length Control. Length 2 is the maximum label length if in Variable Length Mode, or the second fixed length if in Fixed Length Mode. Characters can be set from 0001 to 0145 characters in increments of 0001 (pad with zeros).

See [page 241](#) for detailed instructions on setting this feature.



Select Maxicode Length 2 Setting

To configure this feature, scan the ENTER/EXIT PROGRAMMING MODE bar code above, then the bar code at left followed by the digits from the Alphanumeric characters in [Appendix D, Keypad](#) representing your desired character(s). End by scanning the ENTER/EXIT bar code again.

Make a mistake? Scan the CANCEL bar code to abort and not save the entry string. You can then start again at the beginning.



CANCEL

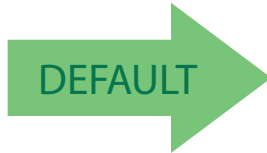

Length 2 is 0145 Characters

PDF417

PDF417 Enable / Disable

Enables/disables the ability of the reader to decode PDF417 labels.



PDF417 Length Control

This feature specifies either variable length decoding or fixed length decoding for this symbology.

Variable Length: For variable length decoding, a minimum and maximum length may be set.

Fixed Length: For fixed length decoding, two different lengths may be set.

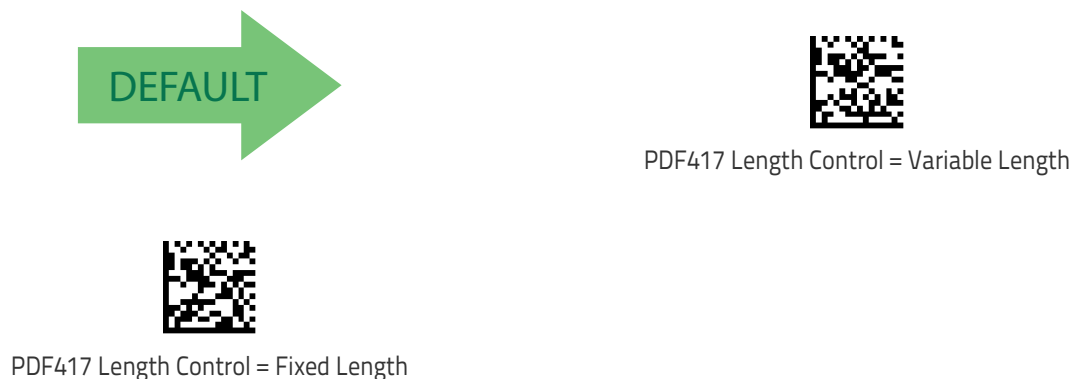



PDF417 Set Length 1

Specifies one of the bar code lengths for PDF417 Length Control. Length 1 is the minimum label length if in Variable Length Mode, or the first fixed length if in Fixed Length Mode. Length includes the bar code's data characters only. Characters can be set from 0001 to 2,710 characters (pad with zeros) in increments of 01. Any value greater than 2,710 will be considered to be 2,710.

See [page 241](#) for detailed instructions on setting this feature.



Select PDF417 Length 1 Setting

To configure this feature, scan the ENTER/EXIT PROGRAMMING MODE bar code above, then the bar code at left followed by the digits from the Alphanumeric characters in [Appendix D, Keypad](#) representing your desired character(s). End by scanning the ENTER/EXIT bar code again.

Make a mistake? Scan the CANCEL bar code to abort and not save the entry string. You can then start again at the beginning.



CANCEL

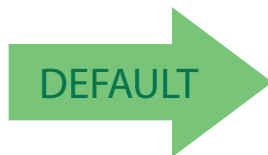

0001 = Length 1 is 1 Character

PDF417 Set Length 2

This feature specifies one of the bar code lengths for PDF417 Length Control. Length 2 is the maximum label length if in Variable Length Mode, or the second fixed length if in Fixed Length Mode. Length includes the bar code's check, data, and full-ASCII shift characters. The length does not include start/stop characters. Characters can be set from 01 to 2,710 characters (pad with zeros) in increments of 01. Any value greater than 2,710 will be considered to be 2,710.

See [page 241](#) for detailed instructions on setting this feature.



Select PDF417 Length 2 Setting

To configure this feature, scan the ENTER/EXIT PROGRAMMING MODE bar code above, then the bar code at left followed by the digits from the Alphanumeric characters in [Appendix D, Keypad](#) representing your desired character(s). End by scanning the ENTER/EXIT bar code again.

Make a mistake? Scan the CANCEL bar code to abort and not save the entry string. You can then start again at the beginning.



CANCEL

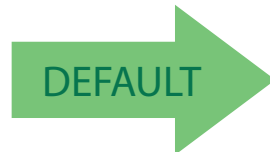

Length 2 is 2,710 Characters



MICRO PDF417

Micro PDF417 Enable / Disable

Enables/disables the ability of the reader to decode Micro PDF417 labels.

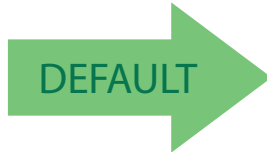

Micro PDF417 = Disable



Micro PDF417 = Enable

Micro PDF417 Code 128 GS1-128 Emulation

Specifies which AIM ID to use for MicroPDF labels when doing Code 128 or GS1-128 emulation.

Emulation choices are:

- Micro PDF AIM ID and label type
- Code 128 / EAN128 AIM Id and label type



Micro PDF417 Code 128 GS1-128 Emulation =
Micro PDF AIM ID and label type



Micro PDF417 Code 128 GS1-128 Emulation =
Code 128 / EAN128 AIM ID and label type

Micro PDF417 Length Control

This feature specifies either variable length decoding or fixed length decoding for this symbology.

Variable Length: For variable length decoding, a minimum and maximum length may be set.

Fixed Length: For fixed length decoding, two different lengths may be set.

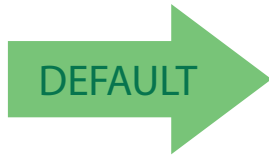

Micro PDF417 Length Control = Variable Length



Micro PDF417 Length Control = Fixed Length

Micro PDF417 Set Length 1

Specifies one of the bar code lengths for **Micro PDF417 Length Control**. Length 1 is the minimum label length if in Variable Length Mode, or the first fixed length if in Fixed Length Mode. Length includes the bar code's data characters only. Characters can be set from 0001 to 0366 characters (pad with zeros) in increments of 01. Any value greater than 0366 will be considered to be 0366. See [page 241](#) for detailed instructions on setting this feature.



Select Micro PDF417 Length 1 Setting

To configure this feature, scan the ENTER/EXIT PROGRAMMING MODE bar code above, then the bar code at left followed by the digits from the Alphanumeric characters in [Appendix D, Keypad](#) representing your desired character(s). End by scanning the ENTER/EXIT bar code again.

Make a mistake? Scan the CANCEL bar code to abort and not save the entry string. You can then start again at the beginning.



CANCEL

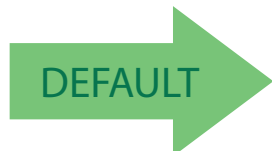

0001 = Length 1 is 1 Character



Micro PDF417 Set Length 2

This feature specifies one of the bar code lengths for Micro PDF417 Length Control. Length 2 is the maximum label length if in Variable Length Mode, or the second fixed length if in Fixed Length includes the bar code's data characters only. Characters can be set from 0001 to 0366 characters (pad with zeros) in increments of 01. Any value greater than 0366 will be considered to be 0366.

See [page 241](#) for detailed instructions on setting this feature.



Select Micro PDF417 Length 2 Setting

To configure this feature, scan the ENTER/EXIT PROGRAMMING MODE bar code above, then the bar code at left followed by the digits from the Alphanumeric characters in [Appendix D, Keypad](#) representing your desired character(s). End by scanning the ENTER/EXIT bar code again.

Make a mistake? Scan the CANCEL bar code to abort and not save the entry string. You can then start again at the beginning.



CANCEL

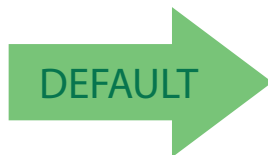

Length 2 is 0366 Characters

QR CODE

QR Code Enable / Disable

Enables/disables the ability of the reader to decode QR Code labels.



QR Code Length Control

This feature specifies either variable length decoding or fixed length decoding for this symbology.

Variable Length: For variable length decoding, a minimum and maximum length may be set.

Fixed Length: For fixed length decoding, two different lengths may be set.

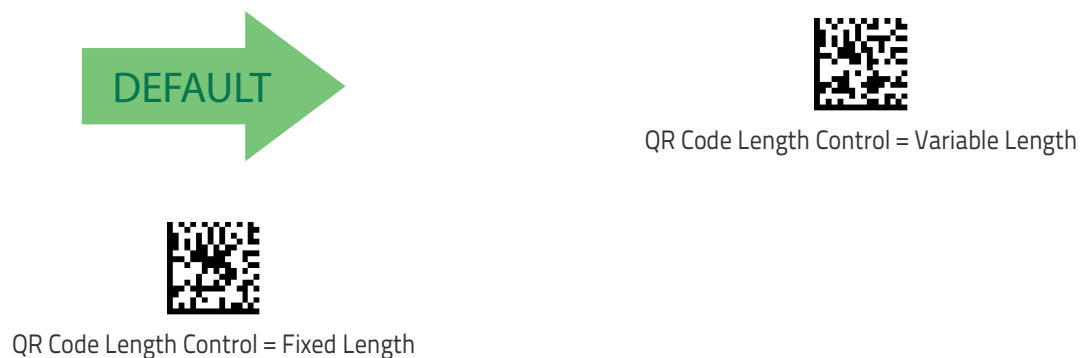



QR Code Set Length 1

Specifies one of the bar code lengths for QR Code Length Control. Length 1 is the minimum label length if in Variable Length Mode, or the first fixed length if in Fixed Length Mode. Characters can be set from 0001 to 7,089 characters in increments of 0001 (pad with zeros).

See [page 241](#) for detailed instructions on setting this feature.



Select QR Code Length 1 Setting

To configure this feature, scan the ENTER/EXIT PROGRAMMING MODE bar code above, then the bar code at left followed by the digits from the Alphanumeric characters in [Appendix D, Keypad](#) representing your desired character(s). End by scanning the ENTER/EXIT bar code again.

Make a mistake? Scan the CANCEL bar code to abort and not save the entry string. You can then start again at the beginning.



CANCEL

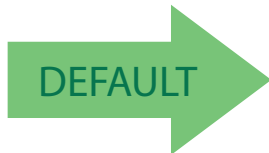

0001 = Length 1 is 1 Character

QR Code Set Length 2

This feature specifies one of the bar code lengths for QR Code Length Control. Length 2 is the maximum label length if in Variable Length Mode, or the second fixed length if in Fixed Length Mode. Characters can be set from 0001 to 7,089 characters in increments of 0001 (pad with zeros).

See [page 241](#) for detailed instructions on setting this feature.



Select QR Code Length 2 Setting

To configure this feature, scan the ENTER/EXIT PROGRAMMING MODE bar code above, then the bar code at left followed by the digits from the Alphanumeric characters in [Appendix D, Keypad](#) representing your desired character(s). End by scanning the ENTER/EXIT bar code again.

Make a mistake? Scan the CANCEL bar code to abort and not save the entry string. You can then start again at the beginning.



CANCEL

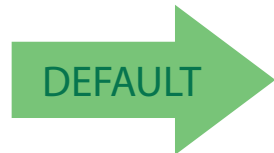

Length 2 is 7,089 Characters



MICRO QR CODE

Micro QR Code Enable/Disable

Enables/disables the ability of the reader to decode Micro QR Code labels.

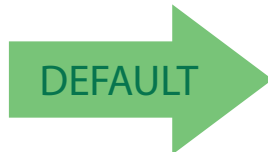

Micro QR Code = Disable



Micro QR Code = Enable

Micro QR Code Length Control

This feature specifies either variable length decoding or fixed length decoding for this symbology.

Variable Length: For variable length decoding, a minimum and maximum length may be set.

Fixed Length: For fixed length decoding, two different lengths may be set.

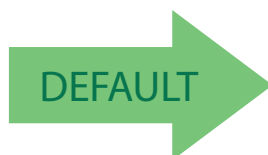

Micro QR Code Length Control = Variable Length



Micro QR Code Length Control = Fixed Length

Micro QR Code Set Length 1

Specifies one of the bar code lengths for Micro QR Code Length Control. Length 1 is the minimum label length if in Variable Length Mode, or the first fixed length if in Fixed Length Mode. Characters can be set from 0001 to 0035 characters in increments of 0001 (pad with zeros).

See [page 241](#) for detailed instructions on setting this feature.



Select Micro QR Code Length 1 Setting

To configure this feature, scan the ENTER/EXIT PROGRAMMING MODE bar code above, then the bar code at left followed by the digits from the Alphanumeric characters in [Appendix D, Keypad](#) representing your desired character(s). End by scanning the ENTER/EXIT bar code again.

Make a mistake? Scan the CANCEL bar code to abort and not save the entry string. You can then start again at the beginning.



CANCEL

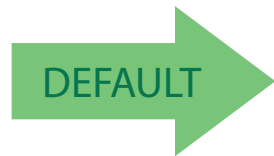

0001 = Length 1 is 1 Character



Micro QR Code Set Length 2

This feature specifies one of the bar code lengths for Micro QR Code Length Control. Length 2 is the maximum label length if in Variable Length Mode, or the second fixed length if in Fixed Length Mode. Characters can be set from 0001 to 0035 characters in increments of 0001 (pad with zeros).

See [page 241](#) for detailed instructions on setting this feature.



Select QR Code Length 2 Setting

To configure this feature, scan the ENTER/EXIT PROGRAMMING MODE bar code above, then the bar code at left followed by the digits from the Alphanumeric characters in [Appendix D, Keypad](#) representing your desired character(s). End by scanning the ENTER/EXIT bar code again.

Make a mistake? Scan the CANCEL bar code to abort and not save the entry string. You can then start again at the beginning.



CANCEL

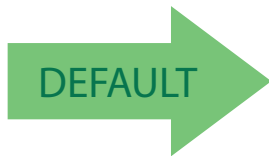

Length 2 is 0035 Characters



UCC COMPOSITE

UCC Composite Enable / Disable

Enables/disables the ability of the reader to decode the stacked part of a UCC Composite label.



This feature is not effective when Global AIM IDs are enabled (see "Global AIM ID" on page 45).

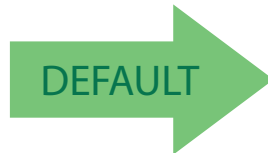

UCC Composite = Disable



UCC Composite = Enable



UCC Optional Composite Timer

Specifies the amount of time the system will wait for the stacked part of a UCC Composite label before transmitting the linear label without an add-on.

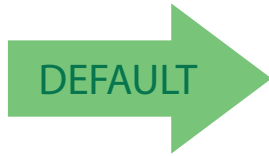

UCC Optional Composite Timer = Timer Disabled



UCC Optional Composite Timer = 100msec



UCC Optional Composite Timer = 200msec



UCC Optional Composite Timer = 300msec



UCC Optional Composite Timer = 400msec



UCC Optional Composite Timer = 500msec

POSTAL CODE SELECTION

Enables/disables the ability of the scanner to decode labels of a specific postal symbology.

- Disable All Postal Codes
- Postnet
- Planet
- Royal Mail
- Kix
- Australia Post
- Japan Post
- IMB
- Sweden Post
- Portugal Post

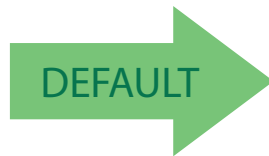

Postal Code Selection = Disable All Postal Codes



Postal Code Selection = Enable Postnet



Postal Code Selection = Enable Planet



Postal Code Selection = Enable Royal Mail



Postal Code Selection = Enable Kix



Postal Code Selection = Enable Australia Post

Postal Code Selection (continued)



Postal Code Selection = Enable Japan Post



Postal Code Selection = Enable IMB



Postal Code Selection = Enable Sweden Post



Postal Code Selection = Enable Portugal Post

Postnet BB Control

Controls the ability of the scanner to decode B and B' fields of Postnet labels.

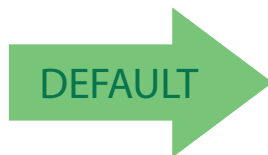

Postnet BB Control = Disable



Postnet BB Control = Enable



Chapter 4

Software Configuration Strings

RS-232 models (as well as USB models with the USB-COM Interface selected) can be configured using serial strings contained in this chapter.

To configure RS-232 using configuration strings:

1. Connect your reader to a PC RS-232 port according to the information in [Attaching Reader to Host, starting on page 6](#). Set the PC serial port to the default RS-232 communication parameters (see [, starting on page 273](#)).



To configure the reader using configuration strings you must enter Service Mode, which automatically sets the reader communication to 115200 baud rate. You must therefore set the host accordingly for RS-232 communications. Upon exiting Service Mode, the programmed baud rate will be restored.

2. Using Datalogic Aladdin (available on the Datalogic website) or a Terminal Emulation Program, send the Restore Current Interface (Custom) Default string to the reader using the syntax described on "Command Syntax" on page 204 page.
3. Send all the necessary command strings according to your application's requirements.

To configure USB (only for USB-COM Interface) using configuration strings:



USB may have USB-KBD interface set as default. They can be easily reconfigured by reading the bar codes in [Interface Selection, starting on page 8](#).

1. Download and install the USB-COM driver from www.datalogic.com.
2. Connect your reader to a PC USB port according to the information in [Attaching Reader to Host, starting on page 6](#).
3. Change the interface to USB-COM by reading the bar code below.

USB-COM



4. Using a Terminal Emulation Program, send the Restore Current Interface (Custom) Default string to the reader using the syntax described on the next page.

- Send all the necessary command strings according to your application's requirements.

Command Syntax

- Enter Service (Serial String Programming) Mode

`$$<CR>`



This command automatically sets the reader communication to 115200 baud rate. Before continuing, please set the baud rate of the Terminal Emulation Program to 115200.

- Send Command

\$	<i>Command</i>	<i>Parameter</i>	<i>Value</i>	<CR>
----	----------------	------------------	--------------	------

Where:

Command:

Description

H <i>AXX</i>	Interface Selection
A <i>A</i>	Enable All Symbologies
A <i>D</i>	Disable All Symbologies
R	Reset Reader
C <i>XXXXXX</i>	Write Single Configuration Item to RAM

Parameter:

X <i>XXX</i>	A 4-character ASCII string See Serial Configuration Strings Table
---------------------	--

Value:

X <i>X</i>	A 2-character Hex string See Serial Configuration Strings Table
-------------------	--

- Apply and Save Configuration to FLASH (permanent memory) and Exit Service Mode

`$Ar<CR>`



This command automatically returns to the programmed baud rate. Before continuing, please set the baud rate of the Terminal Emulation Program to the programmed baud rate.

SERIAL CONFIGURATION STRINGS

ENTER/EXIT CONFIGURATION COMMANDS	
Description	Command
Enter Service Mode (configuration) fixed 115200 Baud rate	S
Exit Service Mode (configuration) return to programmed Baud rate	s
Apply Configuration to RAM (temporary memory) and Exit Service Mode	r01
Apply and Save Configuration to FLASH (permanent memory) and Exit Service Mode	Ar



To configure the reader using configuration strings, it must be placed into Service Mode, which automatically sets the reader communication to 115200 baud rate. You must therefore set the host accordingly for RS-232 communications. Upon exiting Service Mode, the programmed baud rate will be restored.

CONFIGURATION COMMANDS	
Description	Command
Write Single Configuration Item to RAM (temporary memory)	CXXXXXX
Read Single Configuration Item from RAM (temporary memory)	cXXXX
Reset Reader	R
Read Application Software Release (does not require Enter/Exit Service Mode)	\$+\$!
Host Commands Obey	CIFIH00
Host Commands Ignore	CIFIH01
Enable All Symbologies	AA
Disable All Symbologies	AD



The Interface Selection commands store and load the new interface type with its factory defaults into the current configuration.

INTERFACE SELECTION COMMANDS	
Description	Command
Restore Current Interface (Custom) Default Configuration	HA00
RS232-STD	HA05
USB-COM	HA47
RS232-Wincor-Nixdorf	HA12
USB-KBD	HA35
USB-KBD-ALT	HA2B
USB KBD-APPLE	HA2C



To read a particular parameter setting from the reader, send the read parameter command without any value. The reader will respond with its currently configured value.

The Read Application Software Release command is a direct command that does not require entering Service Mode.

RS-232 ONLY PARAMETERS			
Description		Parameter	Value
Baud Rate	1200	R2BA	00
	2400		01
	4800		02
	9600		03
	19200		04
	38400		05
	57600		06
	115200		07
Parity	none	R2PA	00
	even		01
	odd		02
Data Bits	7	R2DA	00
	8		01
Stop Bits	1	R2ST	00
	2		01
Handshaking Control	RTS	R2HC	00
	RTS/CTS	R2HC	01
	RTS/Xon/Xoff	R2HC	02
	RTS On/CTS	R2HC	03
	RTS/CTS Scan Control	R2HC	04

RS-232/USB-COM PARAMETERS			
Description		Parameter	Value
Intercharacter Delay	No delay or from 10 to 990 ms	R2IC	<i>a</i>
Disable Character	Host command character which disables the reader	R2DC	<i>b</i>
Enable Character	Host command character which enables the reader	R2EC	<i>b</i>
ACK/NAK Options	Disable	R2AE	00
	Enable for label transmission		01
	Enable for host command acknowledge		02
	Enable for label transmission and host command acknowledge		03
ACK Character	Selects character to be used as ACK	R2AC	<i>c</i>
NAK Character	Selects character to be used as NAK	R2NA	<i>c</i>
ACK/NAK Timeout Value	No timeout or from 200 to 15000 ms	R2AT	<i>d</i>
ACK/NAK Retry Count	From 0 to unlimited retries	R2AR	<i>e</i>
ACK/NAK Error Handling	Ignore errors detected	R2EH	00
	Process errors as valid ACK character		01
	Process errors as valid NAK character		02
Beep On ASCII BEL	Disable	R2BB	00
	Enable		01
Beep On Not-On-File	Disable	BPNF	00
	Enable		01
Indicate Transmission Failure	Disable	R2TF	00
	Enable		01

a = Hex value from 00 to 63 representing the decimal number (00 = no delay; all others x10 ms)

b = Hex value from 00 to FE representing the ASCII character

c = Hex value from 00 to FF representing the ASCII character

d = Hex value from 00 to 4B representing the decimal number (00 = timeout disabled; all others x200 ms)

e = Hex value from 00 to FF representing the number of retries (00 = no retries; 01-FE = 1-254 retries; FF = unlimited retries)

USB-KBD / USB-KBD-ALT / USB-KBD-APPLE PARAMETERS			
Description		Parameter	Value
Keyboard Country Mode	*US	KBCO	00
	*Belgium		01
	*Britain		02
	Croatia		11
	Czechoslovakia		0E
	Denmark		03
	*France		04
	*Germany		05
	Hungary		0D
	*Italy		06
	Japanese (106 key)		0C
	Norway		07
	Poland		12
	Portugal		08
	Romania		10
	Slovakia		0F
	*Spain		09
*Sweden		0A	
Switzerland		0B	
Send Control Characters	CTRL + KEY	KBSC	00
	CTRL + SHIFT + KEY		01
	Special Function KEY		02
USB Keyboard Speed	1 ms	KBSP	01
	2 ms		02
	3 ms		03
	4 ms		04
	5 ms		05
	6 ms		06
	7 ms		07
	8 ms		08
	9 ms		09
	10 ms		0A

* = Valid for USB-KBD-APPLE

READING PARAMETERS			
Description		Parameter	Value
Double Read Timeout	20 to 2,550 milliseconds (2.55 seconds) in 10ms increments	SNDR	<i>f</i>
Illumination Mode	Disabled	SPIL	00
	Triggered		01
	Enabled		02
Operating Modes	On Line	SNRM	00
	Serial On Line		01
	Automatic		02
Phase Off Event	Automatic (Object Sense)		03
	Trigger Stop	SPTO	00
	Timeout		01
Timeout (Scan Active Time)	Trigger Stop-Timeout		02
	1 to 255 seconds in 1 second intervals.	SNET	<i>h</i>
Serial Start	Any string of characters (max 20) between 00-FE	STON	<i>i</i>
Serial Stop	Any string of characters (max 20) between 00-FE	STOF	<i>i</i>
Label Programming Mode	Disabled	FAPM	00
	Enabled		01

f = Hex value from **02** to **FF** representing the minimum time between same labels

h = Hex value from **02** to **FF** representing the decimal number (x20 ms)

i = Hex value from **00** to **FE** representing the ASCII character

DATA FORMAT			
Description		Parameter	Value
Data Transmission	On Decode	LFTX	01
	After Phase Off		00
Code Verifier Mode	Disabled	LFCV	00
	Transmit Wrong String		01
	Transmit Wrong Code		02
Match String	Any string of characters (max 20) between 00-FE	COVS	<i>k</i>
Wrong Code String	Any string of characters (max 20) between 00-FE	WCVS	<i>k</i>
Case Conversion	Disable	LFCA	00
	Upper Case		01
	Lower Case		02
Global Prefix (Header)	Any string of characters (max 20) between 00-FE	LFPR	<i>k</i>
Global Suffix (Terminator)	Any string of characters (max 20) between 00-FE	LFSU	<i>k</i>
No Read String	Any string of characters (max 20) between 00-FE	NORS	<i>k</i>
	Disable		00
	Enable		01
Character Conversion	An 8-character string between 00-FF	LFCH	<i>m</i>
Transmit AIM IDs	Disable	AIEN	00
	Enable		01
Transmit Custom Label IDs	Disable	IDCO	00
	Prefix		01
	Suffix		02
GS1-128 AIM ID	Disable	U8AI	00
	Enable		01

k = Hex value from 00 to FE representing the ASCII character

m = 8 Hex values from 00 to FF representing the 8 ASCII characters (FF = no replacement or ignore)

Custom Code Identifiers	Any string of characters (max 3) between 00-FE		
UPC-A		ABID	<i>k</i>
UPC-E		EBID	<i>k</i>
EAN-8		8BID	<i>k</i>
EAN-13		3BID	<i>k</i>
UPC-A/P2		A2ID	<i>k</i>
UPC-A/P5		A5ID	<i>k</i>
UPC-E/P2		E2ID	<i>k</i>
UPC-E/P5		E5ID	<i>k</i>
EAN-8/P2		82ID	<i>k</i>
EAN-8/P5		85ID	<i>k</i>
EAN-13/P2		32ID	<i>k</i>
EAN-13/P5		35ID	<i>k</i>
ISBN		ISID	<i>k</i>
ISSN		INID	<i>k</i>
GTIN for EAN/UPC w/o Add-On		GBID	<i>k</i>
GTIN for EAN/UPC w P2		G2ID	<i>k</i>
GTIN for EAN/UPC w P5		G5ID	<i>k</i>
Code 39		C3ID	<i>k</i>
Code 32		P3ID	<i>k</i>
Code 128		C8ID	<i>k</i>
GS1-128		U8ID	<i>k</i>
ISBT 128		I8ID	<i>k</i>
Interleaved 2 of 5		I2ID	<i>k</i>
Standard 2 of 5		S2ID	<i>k</i>
Industrial 2 of 5		U2ID	<i>k</i>
Datalogic 2 of 5		D2ID	<i>k</i>
IATA		IAID	<i>k</i>
Codabar		CBID	<i>k</i>
ABC Codabar		ACID	<i>k</i>
GS1 Databar 14 (Omnidirectional)		4BID	<i>k</i>
GS1 Databar Expanded		XBID	<i>k</i>
GS1 Databar Limited		LBID	<i>k</i>
<i>k</i> = Hex value from 00 to FE representing the ASCII character			
Code 93		C9ID	<i>k</i>
MSI		MSID	<i>k</i>
Plessey		PLID	<i>k</i>

k = Hex value from 00 to FE representing the ASCII character

LED AND BEEPER INDICATORS			
Description		Parameter	Value
Power On Alert	Disable	BPPU	00
	Enable		01
Indicate Good Read	On Decode	BPIN	00
	After Transmit		01
Good Read Beep	Disable	BPVO	00
	Enable		01
Good Read Beep Length	Time length from 10 to 2550 ms	BPLE	o
Good Read Led Duration	Time length from 0 to 25,500 ms	LAGL	f
Green Spot Duration	Disable	LSSP	00
	Short 300ms		01
	Medium 500ms		02
	Long 800ms		03
Led Indication	On Decode	BPIN	00
	After Transmit		01

o = Hex value from **01** to **FF** representing the decimal number (x10 ms)

f = Hex value from **00** to **FF** representing the decimal number (00 = Disable; others x100ms)

CODE SELECTION			
Description		Parameter	Value
UPC-A			
UPC-A	Disable	ABEN	00
	Enable		01
Check Character Tx	Disable	ABCT	00
	Enable		01
Expand to EAN-13	Disable	AB3B	00
	Enable		01
Number System Tx	Disable	ABNS	00
	Enable		01
Minimum Reads	One Read	ABMR	01
	Two Reads		02
	Three Reads		03
	Four Reads		04
Coupon Control	Allow all coupon barcodes to be decoded	CPCL	00
	Enable only UPC-A coupon decoding		01
	Enable only GS1 Databar coupon decoding		02
UPC-E			
UPC-E	Disable	EBEN	00
	Enable		01
Check Character Tx	Disable	EBCT	00
	Enable		01
Expand to UPC-A	Disable	EBAB	00
	Enable		01
Expand to EAN-13	Disable	EB3B	00
	Enable		01
Number System Tx	Disable	EBNS	00
	Enable		01
Minimum Reads	One Read	EBMR	01
	Two Reads		02
	Three Reads		03
	Four Reads		04
EAN-13			
EAN-13	Disable	3BEN	00
	Enable		01
Check Character Tx	Disable	3BCT	00
	Enable		01
ISBN Conversion	Disable	3BIS	00
	Enable		01
ISSN Conversion	Disable	3BIN	00

CODE SELECTION			
Description		Parameter	Value
	Enable		01
Flag 1 Character	Disable	3BF1	00
	Enable		01
Minimum Reads	One Read	3BMR	01
	Two Reads		02
	Three Reads		03
	Four Reads		04
Coupon Control	Allow all coupon barcodes to be decoded	CPCL	00
	Enable only UPC-A coupon decoding		01
	Enable only GS1 Databar coupon decoding		02
EAN-8			
EAN-8	Disable	8BEN	00
	Enable		01
Check Character Tx	Disable	8BCT	00
	Enable		01
Expand to EAN-13	Disable	8B3B	00
	Enable		01
Minimum Reads	One Read	8BMR	01
	Two Reads		02
	Three Reads		03
	Four Reads		04
Add-Ons			
P2 Add-On	Disable	AD02	00
	Enable		01
P5 Add-On	Disable	AD05	00
	Enable		01
P2 Minimum Reads	One Read	ADM2	01
	Two Reads		02
	Three Reads		03
	Four Reads		04
P5 Minimum Reads	One Read	ADM5	01
	Two Reads		02
	Three Reads		03
	Four Reads		04
Optional Add-On Timer	Timer disabled or from 10 to 300 ms	ADOT	<i>p</i>

p = Hex value from 00 to 1E representing the decimal number (00 = Timer disabled; all others x10 ms)

CODE SELECTION			
Description		Parameter	Value
EAN/UPC Global Settings			
GTIN Format	Disable	GBEN	00
	Enable		01
Decoding Level	Disable	UNDL	00
	Level 1		01
	Level 2		02
	Level 3		03
	Level 4		04
	Level 5		05
Character Correlation	Disable	UNCO	00
	Enable		01
In-Store Minimum Reads	One Read	INMR	01
	Two Reads		02
	Three Reads		03
	Four Reads		04
Code 39			
Code 39	Disable	C3EN	00
	Enable		01
Code 39 Full ASCII	Disable	C3FA	00
	Enable		01
Code Length Control	Variable	C3LC	00
	Fixed		01
Set Length	Length 1 (or Min Length) from 1 to 50 characters	C3L1	q
	Length 2 (or Max Length) 0 or from 1 to 50 characters	C3L2	q
Code 32 (Italian Pharma)	Disable	P3EN	00
	Enable		01
Code 32 Check Tx	Disable	P3CT	00
	Enable		01
Code 32 Start/Stop Tx	Disable	P3SS	00
	Enable		01
Check Options			
Check Calculation	Disable	C3CC	00
	Enable Standard Check		01
	Enable Mod-7 Check		02
	Enable Italian Post Check		04
	Enable Daimler Chrysler Check		08

q = Hex value from **00** to **32** representing the decimal number

CODE SELECTION			
Description		Parameter	Value
Code 39 Check Tx	Disable	C3CT	00
	Enable		01
Code 39 Start/Stop Tx	Disable	C3SS	00
	Enable		01
Decoding Options			
Minimum Reads	One Read	C3MR	01
	Two Reads		02
	Three Reads		03
	Four Reads		04
Decoding Level	Disable	C3DL	00
	Level 1		01
	Level 2		02
	Level 3		03
	Level 4		04
	Level 5		05
Interdigit Ratio	Any ratio or 1 to 10	C3IR	<i>r</i>
Character Correlation	Disable	C3CO	00
	Enable		01
Quiet Zones	Quiet Zone on One Side	C3LO	01
	Quiet Zones on Two Sides		02
	Auto		03
	Virtual Quiet Zones on Two Sides		04
	Small Quiet Zones on Two Sides		05
Stitching	Disable	C3ST	00
	Enable		01
Code 128 (GS1-128)			
Code 128	Disable	C8EN	00
	Enable		01
GS1-128 Enable	Enable (transmit labels in Code 128 data format)	U8EN	00
	Enable (transmit labels in GS1-128 data format)		01
	Disable		02
Code Length Control	Variable	C8LC	00
	Fixed		01
Set Length	Length 1 (or Min Length) from 1 to 80 characters	C8L1	<i>s</i>
	Length 2 (or Max Length) 0 or from 1 to 80 characters	C8L2	<i>s</i>

r = Hex value from **00** to **0A** representing the decimal number of the interdigit space/module ratio (00 = any ratio)

s = Hex value from **00** to **50** representing the decimal number

CODE SELECTION			
Description		Parameter	Value
Expand to Code 39	Disable	C8C3	00
	Enable		01
Check Options			
Check Tx	Disable	C8CT	00
	Enable		01
Function Character Tx	Disable	C8TF	00
	Enable		01
Sub-Code Change Tx	Disable	C8SC	00
	Enable		01
Decoding Options			
Minimum Reads	One Read	C8MR	01
	Two Reads		02
	Three Reads		03
	Four Reads		04
Decoding Level	Disable	C8DL	00
	Level 1		01
	Level 2		02
	Level 3		03
	Level 4		04
	Level 5		05
Character Correlation	Disable	C8CO	00
	Enable		01
Quiet Zones	No Quiet Zones	C8LO	00
	Quiet Zone on One Side		01
	Quiet Zones on Two Sides		02
	Auto		03
	Virtual Quiet Zones on Two Sides		04
Stitching	Disable	C8ST	00
	Enable		01
ISBT 128			
ISBT 128 Concatenation	Disable	I8CE	00
	Enable		01
Concatenation Mode	Static	I8CM	00
	Dynamic		01
Dynamic Concat. Timeout	From 50 to 2550 ms	I8DT	t
Chain 0 - Chain 15	Contact Datalogic		

t = Hex value from **05** to **FF** representing the decimal number (x10 ms)

CODE SELECTION			
Description		Parameter	Value
Interleaved 2 of 5 (I 2 of 5)			
I 2 of 5	Disable	I2EN	00
	Enable		01
Code Length Control	Variable	I2LC	00
	Fixed		01
Set Length	Length 1 (or Min Length) from 2 to 50 characters (only even numbers)	I2L1	v
	Length 2 (or Max Length) from 0 or from 2 to 50 characters (only even numbers)	I2L2	v
Check Options			
Check Calculation	Disable	I2CC	00
	Enable Standard(Mod 10)		01
	Enable German Parcel		02
	Enable DHL		04
	Enable Daimler Chrysler		08
	Enable Bosch		10
Check Tx	Enable Italian Post		20
	Disable	I2CT	00
	Enable		01
Decoding Options			
Minimum Reads	One Read	I2MR	01
	Two Reads		02
	Three Reads		03
	Four Reads		04
Decoding Level	Disable	I2DL	00
	Level 1		01
	Level 2		02
	Level 3		03
	Level 4		04
Character Correlation	Level 5		05
	Disable	I2CO	00
	Enable		01
Stitching	Disable	I2ST	00
	Enable		01
Zero Pattern	Disable	I2ZP	00
	Enable		01

v = Hex value from 00 or 02 to 32 representing the decimal number

CODE SELECTION			
Description		Parameter	Value
Standard 2 of 5			
Standard 2 of 5	Disable	S2EN	00
	Enable		01
Code Length Control	Variable	S2LC	00
	Fixed		01
Set Length	Length 1 (or Min Length) from 1 to 50 characters	S2L1	v
	Length 2 (or Max Length) 0 or from 1 to 50 characters	S2L2	v
Check Options			
Check Calculation	Disable	S2CC	00
	Enable		01
Check Tx	Disable	S2CT	00
	Enable		01
Decoding Options			
Minimum Reads	One Read	S2MR	01
	Two Reads		02
	Three Reads		03
	Four Reads		04
Decoding Level	Disable	S2DL	00
	Level 1		01
	Level 2		02
	Level 3		03
	Level 4		04
	Level 5		05
Character Correlation	Disable	S2CO	00
	Enable		01
Stitching	Disable	S2ST	00
	Enable		01
Industrial 2 of 5			
Industrial 2 of 5	Disable	U2EN	00
	Enable		01
Code Length Control	Variable	U2LC	00
	Fixed		01
Set Length	Length 1 (or Min Length) from 1 to 50 characters	U2L1	v
	Length 2 (or Max Length) 0 or from 1 to 50 characters	U2L2	v
Check Options			
Check Calculation	Disable	U2CC	00
	Enable		01

v = Hex value from **00** or **02** to **32** representing the decimal number

CODE SELECTION			
Description		Parameter	Value
Check Tx	Disable	U2CT	00
	Enable		01
Decoding Options			
Minimum Reads	One Read	U2MR	01
	Two Reads		02
	Three Reads		03
	Four Reads		04
Character Correlation	Disable	U2CO	00
	Enable		01
Stitching	Disable	U2ST	00
	Enable		01
IATA			
IATA	Disable	IAEN	00
	Enable		01
Check Tx	Disable	IACT	00
	Enable		01
Datalogic 2 of 5			
Datalogic 2 of 5	Disable	D2EN	00
	Enable		01
Code Length Control	Variable	D2LC	00
	Fixed		01
Set Length	Length 1 (or Min Length) from 1 to 50 characters	D2L1	v
	Length 2 (or Max Length) 0 or from 1 to 50 characters	D2L2	v
Check Options			
Check Calculation	Disable	D2CC	00
	Enable		01
Check Tx	Disable	D2CT	00
	Enable		01
Decoding Options			
Minimum Reads	One Read	D2MR	01
	Two Reads		02
	Three Reads		03
	Four Reads		04
Decoding Level	Disable	D2DL	00
	Level 1		01
	Level 2		02
	Level 3		03

v = Hex value from **00** or **02** to **32** representing the decimal number

CODE SELECTION			
Description		Parameter	Value
	Level 4		04
	Level 5		05
Character Correlation	Disable	D2CO	00
	Enable		01
Stitching	Disable	D2ST	00
	Enable		01
Codabar			
Codabar	Disable	CBEN	00
	Enable		01
Code Length Control	Variable	CBLC	00
	Fixed		01
Set Length	Length 1 (or Min Length) from 3 to 50 characters	CBL1	v
	Length 2 (or Max Length) 0 or from 3 to 50 characters	CBL2	v
ABC Codabar			
ABC Codabar	Disable	CBAB	00
	Enable		01
Concatenation Mode	Static	CBCM	00
	Dynamic		01
Dynamic Concat. Timeout	From 50 to 2550 ms	CBDT	t
Check Options			
Check Calculation	Disable	CBCC	00
	Enable AIM Standard Check		01
	Enable Mod-10 Check		02
Check Tx	Disable	CBCT	00
	Enable		01
Start/Stop Set	ABCD/TN*E	CBSC	00
	ABCD/ABCD		01
	abcd/tn*e		02
	abcd/abcd		03
Start/Stop Tx	Disable	CBSS	00
	Enable		01
Start/Stop Match	Disable	CBSM	00
	Enable		01
Decoding Options			
Minimum Reads	One Read	CBMR	01
	Two Reads		02

v = Hex value from 00 or 02 to 32 representing the decimal number

t = Hex value from 05 to FF representing the decimal number (x10 ms)

CODE SELECTION			
Description		Parameter	Value
	Three Reads		03
	Four Reads		04
Decoding Level	Disable	CBDL	00
	Level 1		01
	Level 2		02
	Level 3		03
	Level 4		04
	Level 5		05
Character Correlation	Disable	CBCO	00
	Enable		01
Interdigit Ratio	Any ratio or 1 to 10	CBIR	<i>r</i>
Quiet Zones	Quiet Zone on One Side	CBLO	01
	Quiet Zones on Two Sides		02
	Auto		03
	Virtual Quiet Zones on Two Sides		04
	Small Quiet Zones on Two Sides		05
Stitching	Disable	CBST	00
	Enable		01
GS1 Databar Omnidirectional			
GS1 Databar Omnidirectional	Disable	4BEN	00
	Enable		01
GS1-128 Emulation	Disable	4BU8	00
	Enable		01
Omnidirectional Decoding Options			
Minimum Reads	One Read	4BMR	01
	Two Reads		02
	Three Reads		03
	Four Reads		04
GS1 Databar Expanded			
GS1 Databar Expanded	Disable	XBEN	00
	Enable		01
GS1-128 Emulation	Disable	XBU8	00
	Enable		01
Code Length Control	Variable	XBLC	00
	Fixed		01

r = Hex value from **00** to **0A** representing the decimal number of the interdigit space/module ratio
(**00** = any ratio)

CODE SELECTION			
Description		Parameter	Value
Set Length	Length 1 (or Min Length) from 1 to 74 characters	XBL1	w
	Length 2 (or Max Length) 0 or from 1 to 74 characters	XBL2	w
Expanded Decoding Options			
Minimum Reads	One Read	XBMR	01
	Two Reads		02
	Three Reads		03
	Four Reads		04
Coupon Control	Allow all coupon barcodes to be decoded	CPCL	00
	Enable only UPC-A coupon decoding		01
	Enable only GS1 Databar coupon decoding		02
GS1 Databar Limited			
GS1 Databar Limited	Disable	LBEN	00
	Enable		01
GS1-128 Emulation	Disable	LBU8	00
	Enable		01
Limited Decoding Options			
Minimum Reads	One Read	LBMR	01
	Two Reads		02
	Three Reads		03
	Four Reads		04
Code 93			
Code 93	Disable	C9EN	00
	Enable		01
Code Length Control	Variable	C9LC	00
	Fixed		01
Set Length	Length 1 (or Min Length) from 1 to 50 characters	C9L1	v
	Length 2 (or Max Length) 0 or from 1 to 50 characters	C9L2	v
Check Options			
Check Calculation	Disable	C9CC	00
	Enable Check C		01
	Enable Check K		02
	Enable Check C and K		03
Check Tx	Disable	C9CT	00
	Enable		01
Decoding Options			
Minimum Reads	One Read	C9MR	01

w = Hex value from **00** to **4A** representing the decimal number

v = Hex value from **00** or **02** to **32** representing the decimal number

CODE SELECTION			
Description		Parameter	Value
	Two Reads		02
	Three Reads		03
	Four Reads		04
Decoding Level	Disable	C9DL	00
	Level 1		01
	Level 2		02
	Level 3		03
	Level 4		04
	Level 5		05
Character Correlation	Disable	C9CO	00
	Enable		01
Quiet Zones	No Quiet Zones	C9LO	00
	Quiet Zone on One Side		01
	Quiet Zones on Two Sides		02
	Auto		03
	Virtual Quiet Zones on Two Sides		04
Stitching	Disable	C9ST	00
	Enable		01
MSI			
MSI	Disable	MSEN	00
	Enable		01
Code Length Control	Variable	MSLC	00
	Fixed		01
Set Length	Length 1 (or Min Length) from 1 to 50 characters	MSL1	v
	Length 2 (or Max Length) 0 or from 1 to 50 characters	MSL2	v
Check Options			
Check Calculation	Disable	MSCC	00
	Enable Mod 10		01
	Enable Mod 11/10		02
	Enable Mod 10/10		03
Check Tx	Disable	MSCT	00
	Enable		01
Decoding Options			
Minimum Reads	One Read	MSMR	01
	Two Reads		02
	Three Reads		03
	Four Reads		04

v = Hex value from 00 or 02 to 32 representing the decimal number

CODE SELECTION			
Description		Parameter	Value
Decoding Level	Disable	MSDL	00
	Level 1		01
	Level 2		02
	Level 3		03
	Level 4		04
	Level 5		05
Stitching	Disable	MSST	00
	Enable		01
Plessey			
Plessey	Disable	PLEN	00
	Enable		01
Code Length Control	Variable	PLLC	00
	Fixed		01
Set Length	Length 1 (or Min Length) from 1 to 50 characters	PLL1	v
	Length 2 (or Max Length) 0 or from 1 to 50 characters	PLL2	v
Check Options			
Check Calculation	Disable	PLCC	00
	Standard		01
	Anker Calculation		02
	Standard and Anker Calculation		03
Check Tx	Disable	PLCT	00
	Enable		01
Decoding Options			
Minimum Reads	One Read	PLMR	01
	Two Reads		02
	Three Reads		03
	Four Reads		04
Decoding Level	Disable	PLDL	00
	Level 1		01
	Level 2		02
	Level 3		03
	Level 4		04
	Level 5		05
Character Correlation	Disable	PLCO	00
	Enable		01
Stitching	Disable	PLST	00
	Enable		01

v = Hex value from 00 or 02 to 32 representing the decimal number

2D CODES

2D GLOBAL FEATURES			
Description		Parameter	Value
2D Max Decoding Time	10-2550 ms in 10ms intervals	DETM	<i>h</i>
2D Structured Append	Disabled	DESA	00
	Enabled		01
2D Normal/Inverse Symbol Control	Normal	IPNR	00
	Inverse		01
	Both Normal & Inverse		02

2D CODE SELECTION			
Aztec Code			
Aztec Code	Disabled	AZEN	00
	Enabled		01
Code Length Control	Variable	AZLC	00
	Fixed		01
Set Length	Length1 (Min for Variable) 1	AZL1	<i>q</i>
	Length2 (Max for Variable) 3832	AZL2	<i>q</i>
China Sensible Code			
China Sensible Code	Disabled	CSEN	00
	Enabled		01
Code Length Control	Variable	CSLC	00
	Fixed		01
Set Length	Length1 (Min for Variable) 1	CSL1	<i>r</i>
	Length2 (Max for Variable) 7827	CSL2	<i>r</i>
Data Matrix			
Data Matrix	Disabled	DMEN	00
	Enabled		01
Style	Square	DMDM	3FFF0BDF
	Rectangular		0000F420
	Both Square & Rectangular		3FFFFFFF
Code Length Control	Variable	DMLC	00
	Fixed		01

h = Hex value from 01-FF

q = Hex value from 0001 - 0EF8

r = Hex value from 0001 - 1E931

2D CODE SELECTION			
Description		Parameter	Value
Set Length	Length1 (Min for Variable) 1	DML1	<i>t</i>
	Length2 (Max for Variable) 3116	DML2	<i>t</i>
Maxicode			
Maxicode	Disabled	MXEN	00
	Enabled		01
Primary Message TX	Disabled	MXPT	00
	Enabled		01
Code Length Control	Variable	MXLC	00
	Fixed		01
Set Length	Length1 (Min for Variable) 1	MXL1	<i>u</i>
	Length2 (Max for Variable) 145	MXL2	<i>u</i>
PDF417			
PDF417	Disabled	P4EN	00
	Enabled		01
Code Length Control	Variable	P4LC	00
	Fixed		01
Set Length	Length1 (Min for Variable) 1	P4L1	<i>v</i>
	Length2 (Max for Variable) 2710	P4L2	<i>v</i>
Micro PDF417			
Micro PDF417	Disabled	MIEN	00
	Enabled		01
Code 128 GS1-128 Emulation	Micro PDF AIM ID and label type	MIU8	00
	Code 128 / EAN128 AIM ID and label type		01
Code Length Control	Variable	MILC	00
	Fixed		01
Set Length	Length1 (Min for Variable) 1	MIL1	<i>w</i>
	Length2 (Max for Variable) 366	MIL2	<i>w</i>
QR Code			
QR Code	Disabled	QREN	00
	Enabled		01
Code Length Control	Variable	QRLC	00
	Fixed		01

t = Hex value from 0001 - 0C2C

u = Hex value from 0001 - 0091

v = Hex value from 0001 - 0A96

w = Hex value from 0001 - 016E

2D CODE SELECTION			
Description		Parameter	Value
Set Length	Length1 (Min for Variable) 1	QRL1	<i>x</i>
	Length2 (Max for Variable) 7089	QRL2	<i>x</i>
Micro QR Code			
Micro QR Code	Disabled	MQEN	00
	Enabled		01
Code Length Control	Variable	MLC	00
	Fixed		01
Set Length	Length1 (Min for Variable) 1	ML1	<i>y</i>
	Length2 (Max for Variable) 35	ML2	<i>y</i>
UCC Composite			
UCC Composite	Disabled	CMEN	00
	Enabled		01
Optional Composite Timer	Variable: 00 = disabled, 100-3000 ms in 100ms intervals	CMOT	<i>i</i>
Postal Codes			
Postal Code Selection		POEN	00
Postnet BB Control	Disabled	POBB	00
	Enabled		01

x = Hex value from 0001 - 1BB1

y = Hex value from 0001 - 0023

i = Hex value from 00 - 1E

NOTES



Chapter 5 References

This section contains explanations and examples of selected bar code features. See [Configuration Using Bar Codes](#), starting on page 13 for the actual bar code labels used to configure the reader.

RS-232 PARAMETERS on page 232
• RS-232 Only on page 232
• RS-232/USB COM Parameters on page 233
• USB Intercode Delay on page 240
SYMBOLOGIES on page 241
• Set Length on page 241
DATA EDITING on page 243
• Global Prefix/Suffix on page 244
• Global AIM ID on page 245
• Label ID on page 246
• Character Conversion on page 251
• Scanner Data Formatting Control on page 252
READING PARAMETERS on page 254
• Double Read Timeout on page 254
• Good Read LED Duration on page 255
SCANNING FEATURES on page 256
• Operating Mode on page 256
• Scanning Active Time on page 258
• Aiming Duration Time on page 259
• Multiple Labels Ordering by Code Symbology on page 260

RS-232 Parameters

RS-232 Only

Baud Rate

Baud rate is the number of bits of data transmitted per second. Set the reader's baud rate to match the baud rate setting of the host device. With an improper baud rate setting, data may not reach the host correctly.

Stop Bits

The stop bit(s) at the end of each transmitted character marks the end of transmission of one character and prepares the receiving device for the next character in the serial data stream. The number of stop bits selected (one or two) depends on the number the receiving terminal is programmed to accommodate. Set the number of stop bits to match host device requirements.

Parity

This feature specifies parity required for sending and receiving data. A parity check bit is the most significant bit of each ASCII coded character. Select the parity type according to host device requirements.

- Select None when no parity bit is required.
- Select Odd parity and the parity bit value is set to 0 or 1, based on data, to ensure that an odd number of 1 bits are contained in the coded character.
- Select Even parity and the parity bit value is set to 0 or 1, based on data, to ensure that an even number of 1 bits are contained in the coded character.

Handshaking Control

The data interface consists of an RS-232 port designed to operate either with or without the hardware handshaking lines, Request to Send (RTS), and Clear to Send (CTS). Handshaking Control includes the following options:

- RTS — RTS is asserted during transmissions. CTS is ignored.
- RTS/CTS — RTS is asserted during transmissions. CTS gates transmissions.
- RTS/XON/XOFF — RTS is asserted during transmissions. CTS is ignored. XON and XOFF gate transmissions.
- RTS On/CTS — RTS is always asserted. CTS gates transmissions.
- RTS/CTS Scan Control — RTS is asserted during transmissions. CTS gates transmissions and controls enable and disable state of scanner.

RS-232/USB COM Parameters

Intercharacter Delay

This parameter specifies the intercharacter delay between the end of one character and the beginning of the next. The delay can be set within a range of zero (0) to 990 milliseconds in 10ms increments. A setting of zero specifies no delay.

To set the delay:

1. Determine the desired setting in milliseconds.
2. Divide the desired setting by 10 (setting is in 10ms increments). Pad the result with leading zeros to yield two digits. For example: 0 = 00, 5 = 05, 20 = 20, etc.
3. Scan the ENTER/EXIT PROGRAMMING MODE bar code to enter Programming Mode.
4. Go to [page 23](#) and scan the bar code: SELECT INTERCHARACTER DELAY SETTING.
5. Scan the appropriate two digits from the keypad in [Appendix D, Keypad](#), that represent the duration which was determined in the steps above. You will hear a two-beep indication after the last character.



If you make a mistake before the last character, scan the CANCEL bar code to abort and not save the entry string. You can then start again at the beginning.

6. Scan the ENTER/EXIT PROGRAMMING MODE bar code to exit.

See [Table 25](#) for some examples of how to set this feature.

Table 25. Intercharacter Delay Setting Examples

STEP	ACTION	EXAMPLES			
1	Desired Setting	50ms	150ms	600ms	850ms
2	Divide by 10 (pad with leading zeros to yield two-digits)	05	15	60	85
3	Scan ENTER/EXIT PROGRAMMING MODE				
4	Scan SELECT INTERCHARACTER DELAY SETTING				
5	Scan Two Characters From Appendix D, Keypad	'0' and '5'	'5' and '0'	'6' and '0'	'8' and '5'
6	Scan ENTER/EXIT PROGRAMMING MODE				

ACK NAK Options

Enables/disables the ability of the reader to support RS-232 ACK/NAK protocol. When configured, the reader and/or host sends “ACK” when it receives data properly, and “NAK” when the data is in error. Options are:

- Disable
- Enable for label transmission — The reader expects an ACK/NAK response from the host when a label is sent.
- Enable for host-command acknowledge — The reader will respond with ACK/NAK when the host sends a command.
- Enable for label transmission and host-command acknowledge

ACK Character

This setting specifies an ASCII character or hex value to be used as the ACK character. ASCII characters or any hex value from 0 to 0xFF can be selected.



Setting to previously defined characters such as XON, XOFF, or host commands conflicts with normal operation of these characters. 8-bit data is not recognized when the option [Data Bits](#) has been set as 7 Data Bits.

1. Determine the desired character or value.
 2. Use the [ASCII Chart](#) on the inside back cover of this manual to find the hex equivalent for the desired character/value.
 3. Go to [page 25](#) and scan ENTER/EXIT PROGRAMMING MODE.
 4. Scan the bar code: SELECT ACK CHARACTER SETTING.
 5. Scan the appropriate two alphanumeric characters from the keypad in [Appendix D, Keypad](#), that represent the desired character/value in step 1 above. The second character will cause a two-beep indication.
 6. Scan the ENTER/EXIT PROGRAMMING MODE bar code to exit.
- See [Table 26](#) for some examples of how to set this feature.

Table 26. ACK Character Setting Examples

STEP	ACTION	EXAMPLES			
1	Desired Character/Value	ACK	\$	@	>
2	Hex equivalent from ASCII Chart	0x06	0x24	0x40	0x3E
3	Scan ENTER/EXIT PROGRAMMING MODE				
4	Scan SELECT ACK CHARACTER SETTING				
5	Scan Two Characters from Appendix D, Keypad	'0' and '6'	'2' and '4'	'4' and '0'	'3' AND 'E'
6	Scan ENTER/EXIT PROGRAMMING MODE				

NAK Character

This setting specifies an ASCII character or hex value to be used as the NAK character. ASCII characters or any hex value from 0 to 0xFF can be selected.



Setting to previously defined characters such as XON, XOFF, or host commands conflicts with normal operation of these characters. 8-bit data is not recognized when the option [Data Bits](#) has been set as 7 Data Bits.

To set this feature:

1. Determine the desired character or value.
2. Use the [ASCII Chart](#) on the inside back cover of this manual to find the hex equivalent for the desired character/value.
3. Go to [page 25](#) and scan the ENTER/EXIT PROGRAMMING MODE bar code to enter Programming Mode.
4. Scan the bar code: SELECT NAK CHARACTER SETTING.
5. Scan the appropriate two alphanumeric characters from the keypad in [Appendix D, Keypad](#), that represent the desired character/value in step 1 above. The second character will cause a two-beep indication.
6. Scan the ENTER/EXIT PROGRAMMING MODE bar code to exit Programming Mode.

See [Table 27](#) for some examples of how to set this feature.

Table 27. NAK Character Setting Examples

STEP	ACTION	EXAMPLES			
1	Desired Character/Value	NAK	\$	@	>
2	Hex equivalent from ASCII Chart	0x15	0x24	0x40	0x3E
3	Scan ENTER/EXIT PROGRAMMING MODE				
4	Scan SELECT NAK CHARACTER SETTING				
5	Scan Two Characters From Appendix D, Keypad	'1' and '5'	'2' and '4'	'4' and '0'	'3' AND 'E'
6	Scan ENTER/EXIT PROGRAMMING MODE				

ACK NAK Timeout Value

This option specifies the amount of time the reader waits for an ACK character from the host following label transmission. The selectable timeout range is 200 milliseconds to 15,000ms (15 seconds) in 200ms increments. A selection of 0 disables the timeout.

To set this value:

1. Determine the desired setting in milliseconds.
2. Divide the desired setting by 200 (setting is in 200ms increments). Pad the result with leading zeros to yield two digits. For example: 0 = 00, 5 = 05, 20 = 20, etc.
3. Go to [page 26](#) and scan the ENTER/EXIT PROGRAMMING MODE bar code to enter Programming Mode.
4. Scan the bar code: SELECT ACK NAK TIMEOUT VALUE SETTING.
5. Scan the appropriate two digits from the keypad in [Appendix D, Keypad](#), that represent the duration which was determined in the steps above. You will hear a two-beep indication after the last character.



If you make a mistake before the last character, scan the CANCEL bar code to abort and not save the entry string. You can then start again at the beginning.

6. Scan the ENTER/EXIT PROGRAMMING MODE bar code to exit Programming Mode.

See [Table 28](#) for some examples of how to set this feature.

Table 28. ACK NAK Timeout Value Setting Examples

STEP	ACTION	EXAMPLES			
1	Desired Setting	200ms	1,000ms (1 sec.)	5200ms (5.2 sec.)	15,000ms (15 sec.)
2	Divide by 200	01	05	26	75
3	Scan ENTER/EXIT PROGRAMMING MODE				
4	Scan SELECT ACK NAK TIMEOUT VALUE SETTING				
5	Scan Two Characters From Appendix D, Keypad	'0' and '1'	'0' and '5'	'2' and '6'	'7' and '5'
6	Scan ENTER/EXIT PROGRAMMING MODE				

ACK NAK Retry Count

This feature specifies the number of times the reader retries a label transmission due to a retry condition. The selectable range is from 1 to 254 retries. A selection of 0 disables the count, and a selection of 255 specifies unlimited retries.

To set this feature:

1. Determine the desired setting.
2. Pad the number with leading zeros to yield three digits. For example: 0 = 000, 5 = 005, 20 = 020, etc.
3. Go to [page 26](#) and scan the ENTER/EXIT PROGRAMMING MODE bar code to enter Programming Mode.
4. Scan the bar code: SELECT ACK NAK RETRY COUNT SETTING.
5. Scan the appropriate three digits from the keypad in [Appendix D, Keypad](#), that represent the number which was determined in the steps above. You will hear a two-beep indication after the last character.



If you make a mistake before the last character, scan the CANCEL bar code to abort and not save the entry string. You can then start again at the beginning.

6. Scan the ENTER/EXIT PROGRAMMING MODE bar code to exit Programming Mode.

See [Table 29](#) for some examples of how to set this feature.

Table 29. ACK NAK Retry Count Setting Examples

STEP	ACTION	EXAMPLES			
1	Desired Setting	Disable Retry Count	3 Retries	54 Retries	Unlimited Retries
2	Pad with leading zero(s)	000	003	054	255
3	Scan ENTER/EXIT PROGRAMMING MODE				
4	Scan SELECT ACK NAK RETRY COUNT SETTING				
5	Scan Three Characters From Appendix D, Keypad	'0', '0' and '0'	'0', '0' and '3'	'0', '5' and '4'	'2', '5' and '5'
6	Scan ENTER/EXIT PROGRAMMING MODE				

Disable Character

Specifies the value of the RS-232 host command used to disable the reader. ASCII characters or any hex value from 0 to 0xFF can be selected.



Setting to previously defined characters such as XON, XOFF, or host commands conflicts with normal operation of these characters. 8-bit data is not recognized when the option **Data Bits** has been set as 7 Data Bits.

To set the value:

1. Determine the desired character or value. A setting of 0xFF indicates the Disable Character is not used (not available).
2. Use the [ASCII Chart](#) on the inside back cover of this manual to find the hex equivalent for the desired character/value.
3. Go to [page 28](#) and scan the ENTER/EXIT PROGRAMMING MODE bar code to enter Programming Mode.
4. Scan the bar code: SELECT DISABLE CHARACTER SETTING.
5. Scan the appropriate two alphanumeric characters from the keypad in [Appendix D, Keypad](#), that represent the desired character/value in step 1 above. The second character will cause a two-beep indication.
6. Scan the ENTER/EXIT PROGRAMMING MODE bar code to exit Programming Mode.

Table 30 shows some examples of how to set this feature.

Table 30. Disable Character Setting Examples

STEP	ACTION	EXAMPLES			
1	Desired character/value	'd'	'}'	'D'	Disable Command Not Used
2	Hex equivalent from ASCII Chart	0x64	0x7D	0x44	0xFF
3	Scan ENTER/EXIT PROGRAMMING MODE				
4	Scan SELECT DISABLE CHARACTER VALUE SETTING				
5	Scan Two Characters From Appendix D, Keypad	'6' and '4'	'7' and 'D'	'4' and '4'	'F' AND 'F'
6	Scan ENTER/EXIT PROGRAMMING MODE				

Enable Character

Specifies the value of the RS-232 host command used to enable the reader. ASCII characters or any hex value from 0 to 0xFF can be selected.



Setting to previously defined characters such as XON, XOFF, or host commands conflicts with normal operation of these characters. 8-bit data is not recognized when the option [Data Bits](#) has been set as 7 Data Bits.

To set this feature:

Determine the desired character or value. A setting of 0xFF indicates the Enable Character is not used (not available).

1. Determine the desired character or value.
2. Use the [ASCII Chart](#) on the inside back cover of this manual to find the hex equivalent for the desired character/value.
3. Go to [page 28](#) and scan the ENTER/EXIT PROGRAMMING MODE bar code to enter Programming Mode.
4. Scan the bar code: SELECT ENABLE CHARACTER SETTING.
5. Scan the appropriate two alphanumeric characters from the keypad in [Appendix D, Keypad](#), that represent the desired character/value in step 2 above. The second character will cause a two-beep indication.
6. Scan the ENTER/EXIT PROGRAMMING MODE bar code to exit Programming Mode.

See [Table 31](#) for some examples of how to set this feature.

Table 31. Enable Character Setting Examples

STEP	ACTION	EXAMPLES			
1	Desired character/value	'e'	'}'	'E'	Enable Command Not Used
2	Hex equivalent from ASCII Chart	0x65	0x7D	0x45	0xFF
3	Scan ENTER/EXIT PROGRAMMING MODE				
4	Scan SELECT ENABLE CHARACTER VALUE SETTING				
5	Scan Two Characters From Appendix D, Keypad	'6' and '5'	'7' and 'D'	'4' and '5'	'F' AND 'F'
6	Scan ENTER/EXIT PROGRAMMING MODE				

USB Intercode Delay

Specifies the delay between labels transmitted to the host for this interface. The selectable range for this feature is from 0 to 99 seconds.

Follow these instructions to set this feature:

1. Determine the desired setting.
2. Pad the number with leading zeros to yield two digits. For example: 0 = 00, 5 = 05, 20 = 20, etc
3. Go to [page 35](#) and scan the ENTER/EXIT PROGRAMMING MODE bar code to enter Programming Mode.
4. Scan the bar code: SELECT INTERCODE DELAY SETTING.
5. Scan the appropriate two digits from the keypad in [Appendix D, Keypad](#), that represent the duration which was determined in the steps above. You will hear a two-beep indication after the last character.



If you make a mistake before the last character, scan the CANCEL bar code to abort and not save the entry string. You can then start again at the beginning.

6. Scan the ENTER/EXIT PROGRAMMING MODE bar code to exit Programming Mode.

See [Table 32](#) for some examples of how to set this feature.

Table 32. USB Intercode Delay Examples

STEP	ACTION	EXAMPLES			
1	Desired Setting	No Delay	5 Seconds	60 Seconds	99 Seconds
2	Pad with leading zero(s)	00	05	60	99
3	Scan ENTER/EXIT PROGRAMMING MODE				
4	Scan SELECT INTERCODE DELAY SETTING				
5	Scan Two Characters From Appendix D, Keypad	'0' and '0'	'0' and '5'	'6' and '0'	'9' AND '9'
6	Scan ENTER/EXIT PROGRAMMING MODE				

Symbologies

Set Length

Length Control allows you to select either variable length decoding or fixed length decoding for the specified symbology.

Variable Length: For variable length decoding, a minimum and maximum length may be set.

Fixed Length: For fixed length decoding, two different lengths may be set.

Set Length 1

This feature specifies one of the bar code lengths for Length Control. Length 1 is the minimum label length if in Variable Length Mode, or the first fixed length if in Fixed Length Mode. Length includes the bar code's data characters only.

The number of characters that can be set varies, depending on the symbology. Reference the page for your selected symbology to see specific variables.

1. Determine the desired character length (varies depending on symbology). Pad the number with leading zeros to yield two digits. For example: 0 = 00, 5 = 05, 20 = 20, etc.
2. Go to the Set Length page for your selected symbology and scan the ENTER/EXIT PROGRAMMING MODE bar code to enter Programming Mode.
3. Scan the bar code to SELECT LENGTH 1 SETTING for your selected symbology.
4. Scan the appropriate two digits from the keypad in [Appendix D, Keypad](#), that represent the length setting which was determined in the steps above. You will hear a two-beep indication after the last character.



If you make a mistake before the last character, scan the CANCEL bar code to abort and not save the entry string. You can then start again at the beginning.

5. Scan the ENTER/EXIT PROGRAMMING MODE bar code to exit Prog Mode.

Set Length 2

This feature allows you to set one of the bar code lengths for the specified symbology. Length 2 is the maximum label length if in [Variable Length Mode](#), or the second fixed length if in [Fixed Length Mode](#). See the page for the specific symbology for parameters.

The length that can be set varies depending on the symbology. A setting of 0 specifies to ignore this length (only one fixed length).

Follow these instructions to set this feature:

1. Determine the desired character length (from 1 to 50 — or 0 to ignore this length). Pad the number with leading zeros to yield two digits. For example: 0 = 00, 5 = 05, 20 = 20, etc.
2. Go to the Set Length page for your selected symbology and scan the ENTER/EXIT PROGRAMMING MODE bar code to enter Programming Mode.
3. Scan the bar code to SELECT LENGTH 2 SETTING for your selected symbology.
4. Scan the appropriate two digits from the keypad in [Appendix D, Keypad](#) that represent the length setting which was determined in the steps above. You will hear a two-beep indication after the last character.



If you make a mistake, before the last character scan the CANCEL bar code to abort and not save the entry string. You can then start again at the beginning.

5. Scan the ENTER/EXIT PROGRAMMING MODE bar code to exit Programming Mode.

This completes the procedure.

Data Editing

When a bar code is scanned, additional information can be sent to the host computer along with the bar code data. This combination of bar code data and supplementary user-defined data is called a “message string.” The Data Editing features can be used to build specific user-defined data into a message string.

There are several types of selectable data characters that can be sent before and after scanned data. You can specify if they should be sent with all symbologies, or only with specific symbologies. Figure 3 shows the available elements you can add to a message string:

Figure 3. Breakdown of a Message String

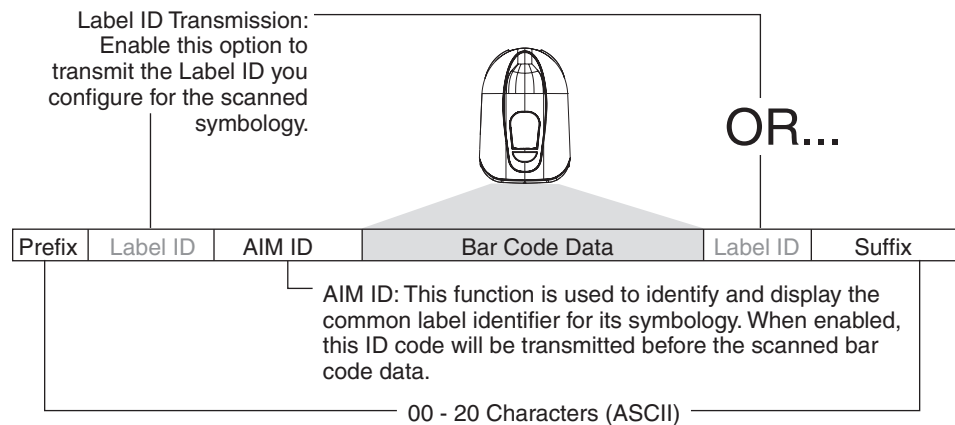

Additional advanced editing is available. See the Advanced formatting features in the Datalogic Aladdin configuration software, or contact Technical Support (as described on [page 2](#)) for more information.

Please Keep In Mind...

- Modifying a message string is not a mandatory requirement. Data editing is a sophisticated feature allowing highly customizable output for advanced users. Factory default settings for data editing is typically set to NONE.
- A prefix or suffix may be applied only to a specified symbology (reference [1D Code Selection, starting on page 79](#)) or across all symbologies (set via the Global features in this chapter).
- You can add any character from the [ASCII Chart](#) (from 00–FF) on the inside back cover of this manual as a prefix, suffix or Label ID.
- Enter prefixes and suffixes in the order in which you want them to appear on the output.

Global Prefix/Suffix

Up to 20 ASCII characters may be added as a prefix (in a position before the bar code data) and/or as a suffix (in a position following the bar code data) as indicated in Figure 4.

Figure 4. Prefix and Suffix Positions

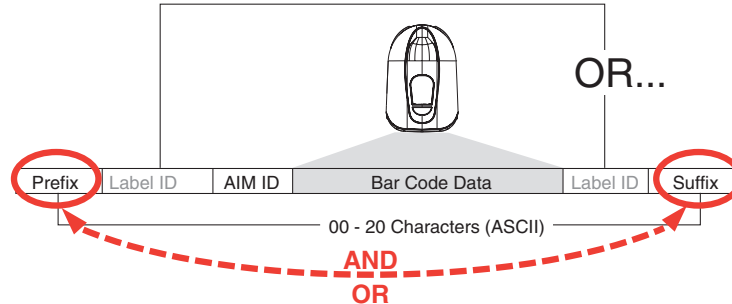

Example: Setting a Prefix

In this example, we'll set a prefix for all symbologies.

1. Determine which ASCII character(s) are to be added to scanned bar code data. In this example, we'll add a dollar sign ('\$') as a prefix.
2. Go to [page 44](#) and scan the ENTER/EXIT PROGRAMMING MODE bar code, then scan the SET GLOBAL PREFIX bar code.
3. Reference the [ASCII Chart](#) on the inside back cover of this manual to find the hex value assigned to the desired character. The corresponding hex number for the '\$' character is 24. To enter this selection code, scan the '2' and '4' bar codes from [Appendix D, Keypad](#).



If you make a mistake before the last character, scan the CANCEL bar code to abort and not save the entry string. You can then start again at the beginning.

4. If less than the expected string of 20 characters are selected, scan the ENTER/EXIT bar code to terminate the string.
5. Scan the ENTER/EXIT bar code once again to exit Programming Mode.
6. The resulting message string would appear as follows:
Scanned bar code data: 12345
Resulting message string output: \$12345

Global AIM ID



This feature enables/disables addition of AIM IDs for all symbology types.

AIM label identifiers (as opposed to custom characters you select yourself as with label identifiers) can be included with scanned bar code data. AIM label identifiers consist of three characters as follows:

- A close brace character (ASCII '['), followed by...
- A code character (see the table below), followed by...
- A modifier character (the modifier character is symbol dependent).

SYMBOLGY	CHAR	SYMBOLGY	CHAR
UPC/EAN	E ^a	Code 128/GS1-128	C
Code 39 and Code 32	A	DataBar Omnidirectional, DataBar Expanded	e
Codabar	F	Standard 2 of 5	S
Interleaved 2 of 5	I	ISBN	X ^b
Code 93	G	Code 11	H

- a. UPC-A and UPC-E labels are converted to EAN 13 when adding AIM IDs.
 b. ISBN (X with a 0 modifier character)

Figure 5. AIM ID

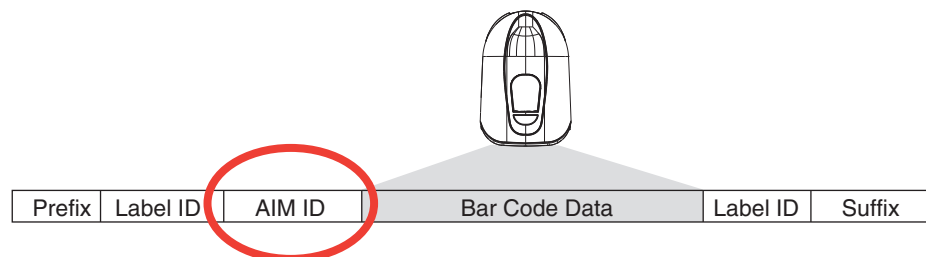

Label ID

A Label ID is a customizable code of up to three ASCII characters (each can be one of hex 0x01–0xFF), used to identify a bar code (symbology) type. It can be appended previous to or following the transmitted bar code data depending upon how this option is enabled. This feature provides options for configuring custom Label IDs as a pre-loaded set (see "Label ID: Pre-loaded Sets" below) or individually per symbology (see "Label ID: Set Individually Per Symbology" on page 249). If you wish to program the reader to always include an industry standard label identifier for ALL symbology types, see "Global AIM ID" on page 45.

Label ID: Pre-loaded Sets

The reader supports two pre-loaded sets of Label IDs. Table 33 shows the USA and the EU sets.



CAUTION

When changing from one Label ID set to another, all other reader configuration settings, including the host interface type, will be erased and set to the standard factory defaults. Any custom configuration or custom defaults will be lost.

Table 33. Label ID Pre-loaded Sets

Symbology	USA Label ID set		EU Label ID set	
	Default Character	Default ASCII	Default Character	Default ASCII
ABC CODABAR	S	530000	S	530000
ANKER PLESSEY	o	6F0000	o	6F0000
AZTEC	Az	417A00	!	210000
CHINA SENSIBLE CODE	\$S	245300	\$S	245300
CODABAR	%	250000	R	520000
CODE11	CE	434500	b	620000
CODE128	#	230000	T	540000
CODE32	A	410000	X	580000
CODE39	*	2A0000	V	560000
CODE39 CIP	Y	590000	Y	590000
CODE39 DANISH PPT	\$Y	245900	\$Y	245900
CODE39 LAPOSTE	\$a	246100	\$a	246100
CODE39 PZN	\$Z	245A00	\$Z	245A00
CODE93	&	260000	U	550000

Symbology	USA Label ID set		EU Label ID set	
	Default Character	Default ASCII	Default Character	Default ASCII
DATABAR 14	R4	523400	u	750000
DATABAR 14 COMPOSITE	R4	523400	c	523400
DATABAR EXPANDED	RX	525800	t	740000
DATABAR EXPANDED COMPOSITE	RX	525800	d	525800
DATABAR LIMITED	RL	524C00	v	760000
DATABAR LIMITED COMPOSITE	RL	524C00	i	524C00
DATA MATRIX	Dm	446D00	w	770000
EAN128		000000	k	6B0000
EAN128 COMPOSITE		000000	\$E	244500
EAN13	F	460000	B	420000
EAN13 P2	F	460000	L	4C0000
EAN13 P5	F	460000	M	4D0000
EAN13 COMPOSITE	F	460000	\$F	244600
EAN8	FF	464600	A	410000
EAN8 P2	FF	464600	J	4A0000
EAN8 P5	FF	464600	K	4B0000
EAN8 COMPOSITE	FF	464600	\$G	244700
FOLLET 2OF5	O	4F0000	O	4F0000
GTIN	G	470000	\$A	244100
GTIN2	G2	473200	\$B	244200
GTIN5	G5	473500	\$C	244300
I2OF5	i	690000	N	4E0000
IATA INDUSTRIAL 2OF5	IA	494100	&	260000
INDUSTRIAL 2OF5	W	570000	W	570000
ISBN	l	490000	@	400000
ISBT128 CONCAT	f	660000	f	660000
ISSN	n	6E0000	n	6E0000
MAXICODE	MC	4D4300	x	780000
MICRO QR	\$Q	245100	\$Q	245100

Symbology	USA Label ID set		EU Label ID set	
	Default Character	Default ASCII	Default Character	Default ASCII
MICRO PDF	mP	6D5000	8	380000
MSI	@	400000	Z	5A0000
PDF417	P	500000	r	720000
PLESSEY	a	610000	a	610000
POSTAL AUSTRALIAN	\$K	244B00	\$K	244B00
POSTAL IMB	\$V	245600	\$V	245600
POSTAL JAPANESE	\$R	245200	\$R	245200
POSTAL KIX	\$U	245500	\$U	245500
POSTAL PLANET	\$W	245700	\$W	245700
POSTAL PORTUGAL	\$P	245000	\$P	245000
POSTAL POSTNET BB	\$L	244C00	\$L	244C00
POSTAL ROYAL MAIL	\$M	244D00	\$M	244D00
POSTAL SWEDISH	\$X	245800	\$X	245800
POSTNET	1	310000	1	310000
QR CODE	QR	515200	y	790000
S25	s	730000	P	500000
TRIOPTIC	\$T	245400	\$T	245400
UPCA	A	410000	C	430000
UPCA P2	A	410000	F	460000
UPCA P5	A	410000	G	470000
UPCA COMPOSITE	A	410000	\$H	244800
UPCE	E	450000	D	440000
UPCE P2	E	450000	H	480000
UPCE P5	E	450000	I	490000
UPCE COMPOSITE	E	450000	\$J	244A00

Label ID: Set Individually Per Symbology

To configure a Label ID individually for a single symbology:

1. Go to [page 49](#) and scan the ENTER/EXIT bar code.
2. Select Label ID position as either BEFORE (Enable as Prefix) or AFTER (Enable as suffix) by scanning the appropriate bar code in the section "Label ID Control" on page 49. Reference Figure 6 for Label ID positioning options if multiple identification features are enabled.
3. Scan a bar code to select the symbology for which you wish to configure a custom Label ID from the section "Label ID Symbology Selection – 1D Symbologies" on page 50.
4. Determine the desired character(s) (you may choose up to three) which will represent the Label ID for the selected symbology.
5. Turn to the [ASCII Chart](#) on the inside back cover of this manual and find the equivalent hex digits associated with your choice of Label ID. For example, if you wish to select an equal sign (=) as a Label ID, the chart indicates its associated hex characters as 3D. Turn to [Keypad, starting on page 289](#) and scan the bar codes representing the hex characters determined. For the example given, the characters '3' and 'D' would be scanned. More examples of Label ID settings are provided in [Table 34](#).



If you make a mistake before the last character, scan the CANCEL bar code to abort and not save the entry string. You can then start again at the beginning.

6. Scan the ENTER/EXIT bar code to exit Label ID entry.
7. Scan the ENTER/EXIT bar code once again to exit Programming Mode.

Figure 6. Label ID Position Options

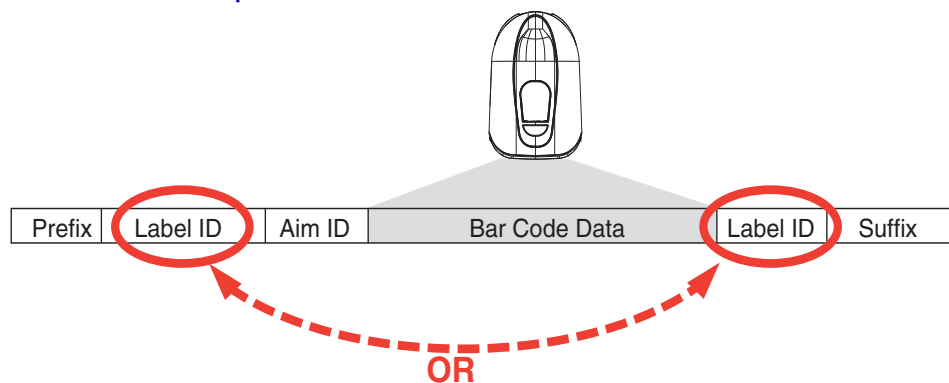

Table 34. Label ID Examples

STEP	ACTION	EXAMPLES			
1.	Scan the ENTER/EXIT bar code	(Scanner enters Programming Mode)			
2.	Determine placement of the Label ID characters BEFORE or AFTER with regard to scanned data using Label ID Control, starting on page 49	Enable as Prefix	Enable as Suffix	Enable as Prefix	Enable as Suffix
3.	Scan the bar code selecting the symbology type you wish to designate label ID characters for using Label ID Symbology Selection – 1D Symbologies, starting on page 50.	DataBar Omnidirectional	Code 39	Interleaved 2 of 5	Code 32
4.	Custom Label ID example (desired characters):	D B *	= C 3	+	P H
5.	Find hex equivalents from the ASCII Chart (inside back cover), then scan in these digits/characters using the bar codes in the section: Keypad, starting on page 289. If you make a mistake before the last character, scan the CANCEL bar code to abort and not save the entry string. You can then start again at the beginning.	44 42 2A	3D 43 33	2B	50 48
6.	Scan the ENTER/EXIT bar code	(Scanner exits Label ID entry)			
7.	Scan the ENTER/EXIT bar code once again	(Scanner exits Programming Mode)			
	Result:	DB*[bar code data]	[bar code data]=C3	+ [bar code data]	[bar code data]PH

Character Conversion

Character conversion is an eight byte configuration item. The eight bytes are 4 character pairs represented in hexadecimal ASCII values. The first character in the pair is the character that will be converted. The second character in the pair is the character to convert to. If the character to convert in a pair is FF, then no conversion is done.

For example, if you have the character conversion configuration item set to the following: 41423132FFFFFFFF

The first pair is 4142 or AB (41 hex is an ASCII capital A, 42 hex is an ASCII capital B) and the second pair is 3132 or 12 (31 hex is an ASCII 1, 32 is an ASCII 2). The other two pairs are FFFF and FFFF.

With the label, AB12BA21, it would look as follows after the character conversion: BB22BB22.

The A characters were converted to B characters and the 1 characters were converted to 2 characters. Nothing is done with the last two character pairs, since they are all FF.

To set Character Conversion:

1. Go to [page 59](#) and scan the ENTER/EXIT bar code.
2. Scan the “Configure Character Conversion” bar code.
3. Determine the desired string. Sixteen positions must be determined as in the above example. Next, turn to the [ASCII Chart](#) on the inside back cover of this manual and find the equivalent hex digits needed to fulfill the string.
4. Turn to [Appendix D, Keypad](#) and scan the bar codes representing the hex characters determined in the previous step.
5. Scan the ENTER/EXIT bar code to exit Programming Mode.



If less than the expected string of 16 characters are selected, scan the ENTER/EXIT bar code twice to accept the selections and exit Programming Mode.

Scanner Data Formatting Control

No Read String

This feature allows the transmission of a programmable character or string when no code has been decoded (No read) during a reading phase (On Line Mode only).

To set this feature:

1. Determine the desired character string (maximum 20).
2. Reference the ASCII Chart on the inside back cover of this manual to find the hex value assigned to the desired character.
3. Go to ["No Read String" on page 55](#) and scan ENTER/EXIT PROGRAMMING MODE to enter Programming Mode
4. Scan the barcode: "Select No Read String."
5. Scan the hex equivalent characters from the keypad in Appendix D that represent the desired character string in step 1 above.
6. If less than the expected string of 20 characters is selected, scan the ENTER/EXIT barcode to terminate the string.
7. Scan the ENTER/EXIT PROGRAMMING MODE barcode once again to exit Programming Mode.

Code Verifier

Code Verifier is available in On Line or Serial On Line and Automatic modes only. A programmable character or string is transmitted after a successful reading phase depending on the result of a comparison between the decoded label and a user specified label.

Code Verifier Mode

Options for this feature are:

- Disable: disable the Code Verifier functionality
- Transmit Wrong String: the reader will transmit the wrong string to the Host.
- Transmit Wrong Code: the reader will transmit the wrong code to the Host.

If the code read matches the code verifier Match String then it is sent to the host through the configured port. If it does not match the code verifier Match String, either the Wrong Code can be sent or the defined Wrong String message can be sent indicating the error.

Match String

The string used as the match code for code verification. The Match String must be configured to include start/stop characters and check digits, if their transmission is enabled.

It is possible to define the Match string by inserting any printable characters or non-printable ASCII characters available in the list inside the parameter edit box

No wild card characters are supported.

To set this feature:

1. Determine the desired character string (max 32).
2. Reference the ASCII Chart on the inside back cover of this manual to find the hex value assigned to the desired character.
3. Go to "[Match String](#)" on [page 57](#) and scan ENTER/EXIT PROGRAMMING MODE to enter Programming Mode.
4. Scan the barcode: SELECT MATCH STRING.
5. Turn to [Appendix D, Keypad](#) and scan the barcodes representing the hex characters determined in step 1 above.
6. If less than the expected string of 32 characters are selected, scan the ENTER/EXIT barcode to terminate the string.
7. Scan the ENTER/EXIT PROGRAMMING MODE barcode to complete.

Wrong Code String

The string sent in case of a mismatch (wrong code read). To set this feature:

1. Determine the desired character string (max 20).
2. Reference the ASCII Chart on the inside back cover of this manual to find the hex value assigned to the desired character.
3. Go to "[Wrong Code String](#)" on [page 57](#) and scan ENTER/EXIT PROGRAMMING MODE to enter Programming Mode.
4. Scan the barcode: SELECT WRONG CODE STRING.
5. Turn to [Appendix D, Keypad](#) and scan the barcodes representing the hex characters determined in step 1 above.
6. If less than the expected string of 20 characters are selected, scan the ENTER/EXIT barcode to terminate the string.
7. Scan the ENTER/EXIT PROGRAMMING MODE barcode to complete.

Label Transmit Mode

Specifies whether the decoded label must be transmitted over the host interface as it has been decoded or after the reading phase has been deactivated (phase off). This does not apply to Test Mode.

Reading Parameters

Double Read Timeout

Double Read Timeout prevents a double read of the same label by setting the minimum time allowed between reads of labels of the same symbology and data. If the unit reads a label and sees the same label again within the specified timeout, the second read is ignored. Double Read Timeout does not apply to scan modes that require a trigger pull for each label read.

Follow these instructions to set this feature:

1. Determine the desired setting in milliseconds.
2. Divide the desired setting by 10 (setting is in 10ms increments). Pad the result with leading zeros to yield three digits. For example: 0 = 000, 5 = 005, 20 = 020, etc.
3. Go to [page 62](#) and scan the ENTER/EXIT PROGRAMMING MODE bar code to enter Programming Mode.
4. Scan the bar code: SET DOUBLE READ TIMEOUT SETTING.
5. Scan the appropriate three alphanumeric characters from the keypad in [Appendix D, Keypad](#) representing the duration which was determined in the steps above. You will hear a two-beep indication after the last character.



If you make a mistake before the last character, scan the CANCEL bar code to abort and not save the entry string. You can then start again at the beginning.

6. Scan the ENTER/EXIT PROGRAMMING MODE bar code to exit Programming Mode.

See [Table 35](#) for some examples of how to set this feature.

Table 35. Double Read Timeout Setting Examples

STEP	ACTION	EXAMPLES			
1	Desired Setting	50ms	150ms	1800ms (1.8 sec.)	2550ms (2.55 sec.)
2	Divide by 10 (and pad with leading zeros)	005	015	180	255
3	Scan ENTER/EXIT PROGRAMMING MODE				
4	Scan SET DOUBLE READ TIMEOUT SETTING				
5	Scan Three Characters From Appendix D, Keypad	'0', '0' and '5'	'0', '1' and '5'	'1', '8' and '0'	'2', '5' and '5'
6	Scan ENTER/EXIT PROGRAMMING MODE				

Good Read LED Duration

This feature specifies the amount of time that the Good Read LED remains on following a good read. The good read LED on time can be set within a range of 10 milliseconds to 2,550 milliseconds (0.001 to 2.55 seconds) in 100ms increments.

Follow these instructions to set this feature:

1. Determine the desired setting in milliseconds. A setting of 0 means that the good read LED stays on until the next time the trigger is pulled.
2. Divide the desired setting by 10 (setting is in 100ms increments). Pad the result with leading zeros to yield three digits. For example: 0 = 000, 5 = 000, 20 = 020, etc.
3. Go to [page 67](#) and scan the ENTER/EXIT PROGRAMMING MODE bar code to enter Programming Mode.
4. Scan the bar code: SELECT GOOD READ LED DURATION SETTING.
5. Scan the appropriate three digits from the keypad in [Appendix D, Keypad](#) representing the duration which was determined in the steps above. You will hear a two-beep indication after the last character.



If you make a mistake before the last character, scan the CANCEL bar code to abort and not save the entry string. You can then start again at the beginning.

6. Scan the ENTER/EXIT PROGRAMMING MODE bar code to exit Programming Mode.

See [Table 36](#) for some examples of how to set this feature.

Table 36. Good Read LED Duration Setting Examples

STEP	ACTION	EXAMPLES			
1	Desired Setting	Good Read LED stays on until next trigger pull (00)	20ms	150ms	2550ms (2.55 sec.)
2	Divide by 10 (and pad with leading zeros)	000	002	015	255
3	Scan ENTER/EXIT PROGRAMMING MODE				
4	Scan SELECT GOOD READ LED DURATION SETTING				
5	Scan Three Characters From Appendix D, Keypad	'0', '0' and '0'	'0', '0' and '2'	'0', '1' and '5'	'2', '5' and '5'
6	Scan ENTER/EXIT PROGRAMMING MODE				

Scanning Features

Operating Mode

The following Operating Modes (Reading Modes) are supported:

On Line (Single Trigger)

In On Line mode, the reading phase is defined as the time between the Phase ON and Phase OFF events. The Phase events can be generated by an external input (trigger) or by the Trigger button. While in this mode the scanner activates reading only during a reading phase.

On Line mode allows the following configurations:

Phase Off Event: Specifies whether the reading phase is closed on a timeout or phase off event. The following selections are available:

- **Trigger Stop:** the reading phase ends when the trigger event stops. Timeout is disabled.
- **Timeout:** the reading phase ends when the timeout is expired. Trigger stop is ignored.
- **Trigger Stop – Timeout:** the reading phase ends when the first event occurred.

Timeout: Specifies the maximum duration for the reading phase. Selections: from 1 to 255 seconds in 1 second increments.

Serial On Line

In Serial On Line mode, a reading phase is defined as the time between two events: phase on and phase off, generated by a message sent from the host interface to the scanner. While in this mode the scanner activates reading only during a reading phase. The message (character or string) is user programmable.

Serial On Line mode configurations:

Serial Start Character (or String): Specifies the string message to be sent over the host interface to activate the reading phase.

Serial Stop Character (or String): Specifies the string message to be sent over the host interface to stop the reading phase.



The Serial Start/Stop Characters must be different and must not contain reserved characters (see [Appendix E, Host Configuration Reserved Characters](#)).

See "Manual Trigger Control" on page 71 to configure control of manual triggering.

Phase Off Event: Specifies whether the reading phase is closed on a timeout or phase off event.

The following selections are available:

- **Trigger Stop:** the reading phase ends when the serial stop character (or string) is received. Timeout is disabled.
- **Timeout:** the reading phase ends when the timeout is expired. Serial stop character (or string) is ignored.
- **Trigger Stop – Timeout:** the reading phase ends when the first event occurred.

Timeout (Scanning Active Time option): Specifies the maximum duration for the reading phase. Selections: from 1 to 255 seconds in 1 second increments.

Automatic (Always On)

In Automatic mode, the scanner is continuously scanning. When a label enters the reading zone and is decoded, no more decodes and reading phases are allowed until the label has left the reading area. In order to guarantee identification of the code in the reading zone, a threshold specifies the number of scans after the successful decode that the scanner will wait before rearming the reading phase. The transmission of the decoded label depends on the configuration of the Transmission Mode parameter.

Automatic (Object Sense)

Automatic/TOS mode is the same as Automatic mode but with the illumination system normally off*. As an object or bar code enters the reading area, illumination is turned ON. Illumination will return to the Presentation Illumination Control setting as the reading phase is closed (see Automatic Mode above).

*Default. The illumination can be programmed for several different operation states (off, dim or on) while the reading phase is not active. See "[Presentation Illumination Control](#)" on page 72.

Scanning Active Time

This setting specifies the amount of time that the reader stays in scan ON state once the state is entered. It controls the Timeout within On Line & Serial On Line read modes Phase Off Event. The range for this setting is from 1 to 255 seconds in 1-second increments.

Follow these instructions to set this feature:

1. Determine the desired setting.
2. Pad the result with leading zeros to yield three digits. For example: 0 = 000, 5 = 005, 20 = 020, etc.
3. Go to [page 72](#) and scan the ENTER/EXIT PROGRAMMING MODE bar code to enter Programming Mode.
4. Scan the bar code: SELECT SCANNING ACTIVE TIME SETTING.
5. Scan the appropriate three digits from the keypad in [Appendix D, Keypad](#), that represent the duration which was determined in the steps above. You will hear a two-beep indication after the last character.



If you make a mistake before the last character, scan the CANCEL bar code to abort and not save the entry string. You can then start again at the beginning.

6. Scan the ENTER/EXIT PROGRAMMING MODE bar code to exit Programming Mode.

See [Table 37](#) for some examples of how to set this feature.

Table 37. Scanning Active Time Setting Examples

STEP	ACTION	EXAMPLES			
1	Desired Setting	1 Second	90 Sec. (1.5 min.)	180 Sec. (3 min.)	255 Seconds (4.25 min.)
2	Pad leading zero(s)	001	090	180	255
3	Scan ENTER/EXIT PROGRAMMING MODE				
4	Scan SELECT SCANNING ACTIVE TIME SETTING				
5	Scan Three Characters From Appendix D, Keypad	'0', '0' and '1'	'0', '9' and '0'	'1', '8' and '0'	'2', '5' and '5'
6	Scan ENTER/EXIT PROGRAMMING MODE				

Aiming Duration Time

Specifies the frame of time the aiming pointer remains on after decoding a label, when in On Line or Serial On Line mode. The range for this setting is from 1 to 255 seconds in 1-second increments.

Follow these instructions to set this feature:

1. Determine the desired setting.
2. Pad the result with leading zeros to yield three digits. For example: 0 = 000, 5 = 005, 20 = 020, etc.
3. Go to [page 73](#) and scan the ENTER/EXIT PROGRAMMING MODE bar code to enter Programming Mode.
4. Scan the bar code: SELECT AIMING DURATION TIME SETTING.
5. Scan the appropriate three digits from the keypad in [Appendix D, Keypad](#), that represent the duration which was determined in the steps above. You will hear a two-beep indication after the last character.



If you make a mistake before the last character, scan the CANCEL bar code to abort and not save the entry string. You can then start again at the beginning.

6. Scan the ENTER/EXIT PROGRAMMING MODE bar code to exit Programming Mode.

See [Table 38](#) for some examples of how to set this feature.

Table 38. Aiming Duration Time Setting Examples

STEP	ACTION	EXAMPLES			
1	Desired Setting	1 Second	90 Sec. (1.5 min.)	180 Sec. (3 min.)	255 Seconds (4.25 min.)
2	Pad leading zero(s)	001	090	180	255
3	Scan ENTER/EXIT PROGRAMMING MODE				
4	Scan SELECT AIMING DURATION TIME SETTING				
5	Scan Three Characters From Appendix D, Keypad	'0', '0' and '1'	'0', '9' and '0'	'1', '8' and '0'	'2', '5' and '5'
6	Scan ENTER/EXIT PROGRAMMING MODE				

Multiple Labels Ordering by Code Symbology

This feature Specifies the transmission ordering by symbology type, when Multiple Labels per Frame is enabled. Up to six symbologies can be selected. zeros must be added to pad the string to 12 characters if not using all six symbologies.

The labels are ordered first as specified in the output mask. Labels present in the volume but not specified will be transmitted as unspecified symbologies in random order as allowed by the reading time sequence. For each label decoded in the volume the reader signals the standard beeper and LED indications.

To specify the symbology order:

1. Determine the symbologies and order you want to specify.
2. Use [Table 40 on page 261](#) to find the hex values for up to six symbologies.
3. Go to [page 78](#) and scan the ENTER/EXIT PROGRAMMING MODE bar code to enter Programming Mode.
4. Scan the bar code: “SELECT SYMBOLOGIES FOR MULTIPLE LABELS ORDERING”.
5. Scan the appropriate two alphanumeric characters from the keypad in [Appendix D, Keypad](#), that represent the desired character/value in step 2 above.
6. Scan zeros if needed to make a 12-character string.
7. When finished, scan the ENTER/EXIT PROGRAMMING MODE bar code to exit Programming Mode.

See [Table 39](#) for some examples of how to set this feature.

Table 39. Multiple Labels Ordering by Code Symbology Examples

STEP	ACTION	EXAMPLES			
1	Desired symbology	Code 39	Data Matrix	Code 128	Aztec
2	Hex equivalent from Table 40	24	0E	0C	4E
3	Scan ENTER/EXIT PROGRAMMING MODE				
4	Scan SELECT SYMBOLOGIES FOR MULTIPLE LABELS ORDERING				
5	Scan Two Characters From Appendix D, Keypad	'2' and '4'	'0' and 'E'	'0' and 'C'	'4' and 'E'
	RESULT	0x240E0C4E0000			
6	Scan ENTER/EXIT PROGRAMMING MODE				

[Table 40 on page 261](#) shows the hex value associated with each symbology.

Table 40. Symbology Hex Values

Hex Value	Symbology ID	Hex Value	Symbology ID
00	Don't care	2C	GTIN5
01	UPC-A	2D	GTIN8
02	UPC-E	2E	S2OF5
03	EAN8	2F	PDF417
04	EAN13	30	CODE11
05	UPC2	31	IATA
06	UPC5	32	MICRO_PDF
07	C128_ADDON	33	GS1 DataBar_LIM_ID
0A	EAN128	34	GS1 DataBar_LIM_COMP
0B	C128_PROGRAMMING_LABEL	35	GS1 DataBar_Omnidirectional_COMP
0C	CODE128	36	GS1 DataBar_EXP_COMP
0D	FNC3_C128_LABEL	37	GENERIC_DATA
0E	DATA MATRIX	38	CC_A
0F	MAXICODE	39	CC_B
10	QRCODE	3A	CC_C
11	Reserved	3B	LABELIMAGE
12	Reserved	3C	CAPTURE_IMAGE_LABEL
13	CODE49	3D	Reserved
14	UPC-E2	3E	M2OF5
15	UPC-E5	3F	D2OF5
16	Reserved	40	PLESSEY65
17	UPC-A2	42	ISSN
18	UPC-A5	43	ISBT
19	Reserved	44	Reserved
1A	EAN82	45	TIMER_EXPIRED_EVENT
1B	EAN85	46	FOLLETT_2OF5
1C	Reserved	47	Reserved
1D	EAN132	48	Reserved
1E	EAN135	49	CODE39_CIP
1F	EAN138	4A	ABC_CODABAR
20	ISBN_ID	4B	I2OF5_CIP
21	TWO_LABEL_PAIR	4C	C2OF5
22	I2OF5	4D	IND2OF5
23	CODABAR	4E	AZTEC
24	CODE39	4F	UPC-E_COMP
25	PHARMAC39	50	UPC-A_COMP
26	MSI_PLESSEY	51	EAN8_COMP
27	CODE93	52	EAN13_COMP
28	RSS_EXP_ID	53	EAN128_COMP
29	RSS_14_ID	54	DATA MATRIX_PROGRAMMING_LABEL
2A	GTIN	55	LABEL_ID_MAX
2B	GTIN2	FF	INVALID_LABEL_TYPE

NOTES



Appendix A

Technical Specifications

This section contains Physical and Performance Characteristics, User Environment and Regulatory information.

Table 41. Technical Specifications

ITEM	DESCRIPTION	
Physical Characteristics		
Color	White/Gray Black/Gray	
Dimensions	Without Stand Height: 74 Length: 95 Width: 64	With Stand Height: 121 Length: 107 Width: 73
Weight	Without Stand: 295.0 g / 10.4 oz	With Stand: 178.0 g / 6.3 oz
Electrical Characteristics		
Input Voltage	5 VDC \pm 5% Overvoltage tolerant to 14VDC	

Item	Description
Current & Power Consumption	
Input current at 5V in Automatic (Object Sense) Reading Mode	
Operating (typical)	<180 mA
Operating (max)	<200 mA
Operating (peak*)	<300 mA
Idle/standby (typical)	55 mA (OnLine & Serial OnLine Modes)
	105 mA (Automatic Object Sense Mode)
	No idle in Automatic Mode
Performance Characteristics	
Nominal Frame Rate	53 frames/second
Light Source	Dual Red LEDs
Roll (Tilt) Tolerance	Up to $\pm 180^\circ$
Pitch Tolerance	$\pm 40^\circ$
Skew (Yaw) Tolerance	$\pm 40^\circ$
Print Contrast Minimum	25% minimum reflectance
Field of View	40° H x 26° V

* Peak hold sample time 100mS

Depth of Field (Typical)	NF = Near Field FF = Far Field	cm		inches	
		NF	FF	NF	FF
Code 39 4mil		4.2	15.4	1.7	6.0
Code 39 5mil		2.6	18.8	1.0	7.4
Code 39 10mil		0.0	37.9	0.0	14.9
Code 39 20mil		0.0	57.1	0.0	22.5
EAN 7.5mil		1.2	25.5	0.5	10.0
EAN 13mil		0.8	42.2	0.3	16.6
PDF-417 6.6mil		1.6	13.7	0.6	5.4
PDF-417 10mil		0.0	22.4	0.0	8.8
PDF-417 15mil		0.0	34.6	0.0	13.6
DataMatrix 10mil		2.3	14.5	0.9	5.7
DataMatrix 15mil		0.0	23.2	0.0	9.1
QR Code 10mil		2.3	14.3	0.9	5.6
QR Code 15mil		0.0	23.0	0.0	9.0
Minimum Element Width	1D Min Resolution = 4 mil PDF-417 Min Resolution = 5 mil Datamatrix Min Resolution= 7 mil				

* 13 mils DOF based on EAN. All others are Code 39. All labels grade A, minimum illumination 100 lux, 20°C, label inclination 10°, static reading.

Decode Capability	
1D Bar Codes	
UPC/EAN/JAN (A, E, 13, 8); UPC/EAN/JAN (including P2 /P5); UPC/EAN/JAN (including; ISBN / Bookland & ISSN); UPC/EAN Coupons; Code 39 (including full ASCII); Code 39 Trioptic; Code39 CIP (French Pharmaceutical); LOGMARS (Code 39 w/ standard check digit enabled); Danish PPT; Code 32 (Italian Pharmacode 39); Code 128; Code 128 ISBT; Interleaved 2 of 5; Standard 2 of 5; Interleaved 2 of 5 CIP (HR); Industrial 2 of 5; Discrete 2 of 5; Datalogic 2 of 5 (China Post Code/Chinese 2 of 5); IATA 2of5 Air cargo code; Code 11; Codabar; Codabar (NW7); ABC Codabar; EAN 128; Code 93 ; MSI; PZN; Plessey; Anker Plessey; GS1 DataBar Omnidirectional; GS1 DataBar Limited; GS1 DataBar Expanded; GS1 DataBar Truncated; DATABAR Expanded Coupon.	
2D / Stacked Codes	
The Gryphon I GPS4400 scanner is capable of decoding the following symbologies using multiple frames (i.e. Multi-Frame Decoding): Datamatrix; Inverse Datamatrix; Datamatrix is configurable for the following parameters;; Normal or Inverted; Square or Rectangular Style; Data length (1 - 3600 characters); Maxicode; QR Codes (QR, Micro QR and Multiple QR Codes); Aztec; Postal Codes - (Australian Post; Japanese Post; KIX Post; Planet Code; Postnet; Royal Mail Code (RM45CC); Intelligent Mail Barcode (IMB); Sweden Post; Portugal Post); LaPoste A/R 39; 4-State Canada; PDF-417; MacroPDF; Micro PDF417; GS1 Composites (1 - 12); Codablock F; French CIP13 ^a ; GS1 DataBar Stacked; GS1 DataBar Stacked Omnidirectional; GS1 DataBar Expanded Stacked; GSI Databar Composites; Chinese Sensible Code; Inverted 2D codes ^b .	
^a It is acceptable to handle this with ULE (User Label Edit).	
^b The SW can apply the Normal/Reverse Decoding Control to the following symbologies: Datamatrix, QR, Micro QR, Aztec and Chinese Sensible Code.	
 The Scanner can also decode mirrored images of 2D matrix codes Datamatrix, QR Code and Maxicode.	
Interfaces Supported	RS-232 types: STD, W-N & OPOS USB types: COM, KBD & OEM
User Environment	
Operating Temperature	0° to 50° C (32° to 122° F)
Storage Temperature	-40° to 70° C (-40° to 158° F)
Humidity	Operating: 5% to 90% relative humidity, non condensing
Drop specifications	5 drops from 4 feet (1.2 m) to concrete
Ambient Light immunity	Up to 100,000 Lux
Contaminants	IEC529-IP52
ESD Level	16 KV
Regulatory	
LED Emission Class	(IEC-62471:2006-07) Exempt (No Risk) IEC60825-1: 2007
Electrical Safety	IEC/EN60950-1
EMI/EMC	EN55022/EN55024
Laser Safety	IEC Class 2
Wavelength:	650nm
Beam Divergence:	±8°
Pulse Duration:	Continuous Wave
Max Power Output:	1mW Avg.

LED and Beeper Indications

The top of the product has a button and an indicator LED:

Trigger Button	Press for manual trigger
Green LED ON =	Good Read or trigger button press
Green LED Blinks =	USB enumeration or interface inactive, waiting for change of configuration, during transfer of captured image, or during Flash memory updates

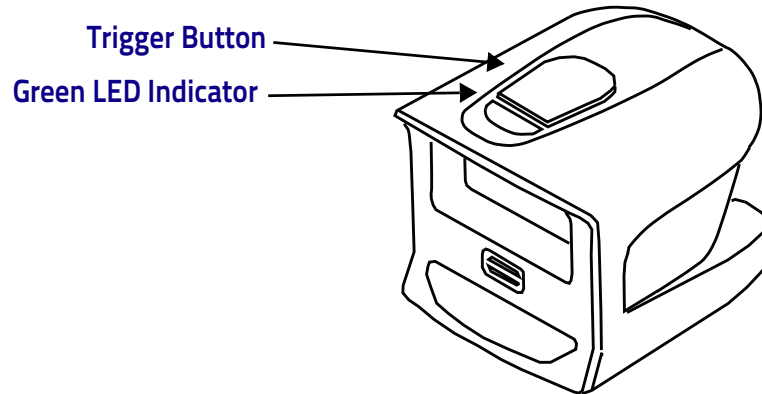

Indicators

The reader's beeper sounds and its LED illuminates to indicate various functions or errors on the reader. An optional "Green Spot" also performs useful functions. The following tables list these indications. One exception to the behaviors listed in the tables is that the reader's functions are programmable, and so may or may not be turned on. For example, certain indications such as the power-up beep can be disabled using programming bar code labels.

Indicator	Description	LED	Beeper
Power-up Beep	The reader is in the process of powering-up.		Reader beeps four times at highest frequency and volume upon power-up.
Good Read Beep	A label has been successfully scanned by the reader.	LED behavior for this indication is configurable via the feature 'Good Read: When to Indicate' (see the PRG for information.)	The reader will beep once at current frequency, volume, mono/bi-tonal setting and duration upon a successful label scan.

Indicator	Description	LED	Beeper
ROM Failure	There is an error in the reader's software/programming	Flashes	Reader sounds one error beep at highest volume.
Limited Scanning Label Read	Indicates that a host connection is not established.	N/A	Reader 'chirps' six times at the highest frequency and current volume.
Reader Active Mode	The reader is active and ready to scan.	The LED is lit steadily ^a	N/A
Reader Disabled	The reader has been disabled by the host.	The LED blinks continuously	N/A
Green Spot ^a flashes momentarily	Upon successful read of a label, the software shall turn the green spot on for the time specified by the configured value.	N/A	N/A
Image Capture	On when ready to capture image	LED on	N/A
Flash Memory Update	Occurs while update is in progress	LED blinks	

^aExcept when in sleep mode or when a Good Read LED Duration other than 00 is selected

Programming Mode: The following indications ONLY occur when the reader is in Programming Mode.

Indicator	Description	LED	Beeper
Label Programming Mode Entry	A valid programming label has been scanned.	LED blinks continuously	Reader sounds four low frequency beeps.
Label Programming Mode Rejection of Label	A label has been rejected.	N/A	Reader sounds three times at lowest frequency and current volume.
Label Programming Mode Acceptance of Partial Label	In cases where multiple labels must be scanned to program one feature, this indication acknowledges each portion as it is successfully scanned.	N/A	Reader sounds one short beep at highest frequency and current volume.
Label Programming Mode Acceptance of Programming	Configuration option(s) have been successfully programmed via labels and the reader has exited Programming Mode.	N/A	Reader sounds one high frequency beep and 4 low frequency beeps followed by reset beeps.
Label Programming Mode Cancel Item Entry	Cancel label has been scanned.	N/A	Reader sounds two times at low frequency and current volume.

Error Codes

Upon startup, if the reader sounds a long tone, this means the reader has not passed its automatic Selftest and has entered FRU (Field Replaceable Unit) isolation mode. If the reader is reset, the sequence will be repeated. Press and release the trigger to hear the FRU indication code.

The following table describes the LED flashes/beep codes associated with an error.

Number of LED Flashes/Beeps	Error	Corrective Action
1	Configuration	Contact Helpdesk for assistance
2	Interface PCB	
6	Digital PCB	
11	Imager	

Host Interface Connections

The reader auto-detects if a USB host cable is attached at powerup, and switches the host interface to USB in that event.

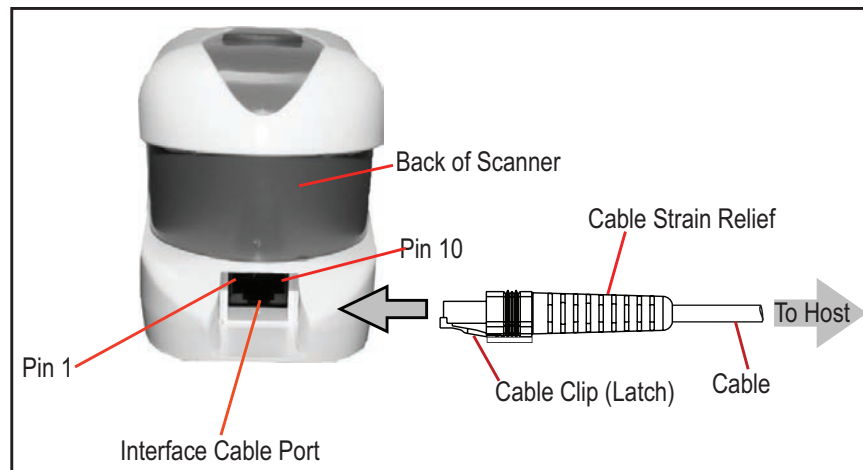

1	RTS	(out) RS-232 Request to Send (output from scanner)
2	D+	USB D Plus
3	D-	USB D Minus
4	GND	Ground
5	RX	RS-232 Receive Data (input to scanner)
6	TX	RS-232 Transmit Data (output from scanner)
7	VCC	+5Vdc
8	NC	No connection
9	NC	No connection
10	CTS	(in) RS-232 Clear To Send (input to scanner)

GPS4400 Dimensions

Figure 7. GPS4400 Without Stand

Dimensions in mm

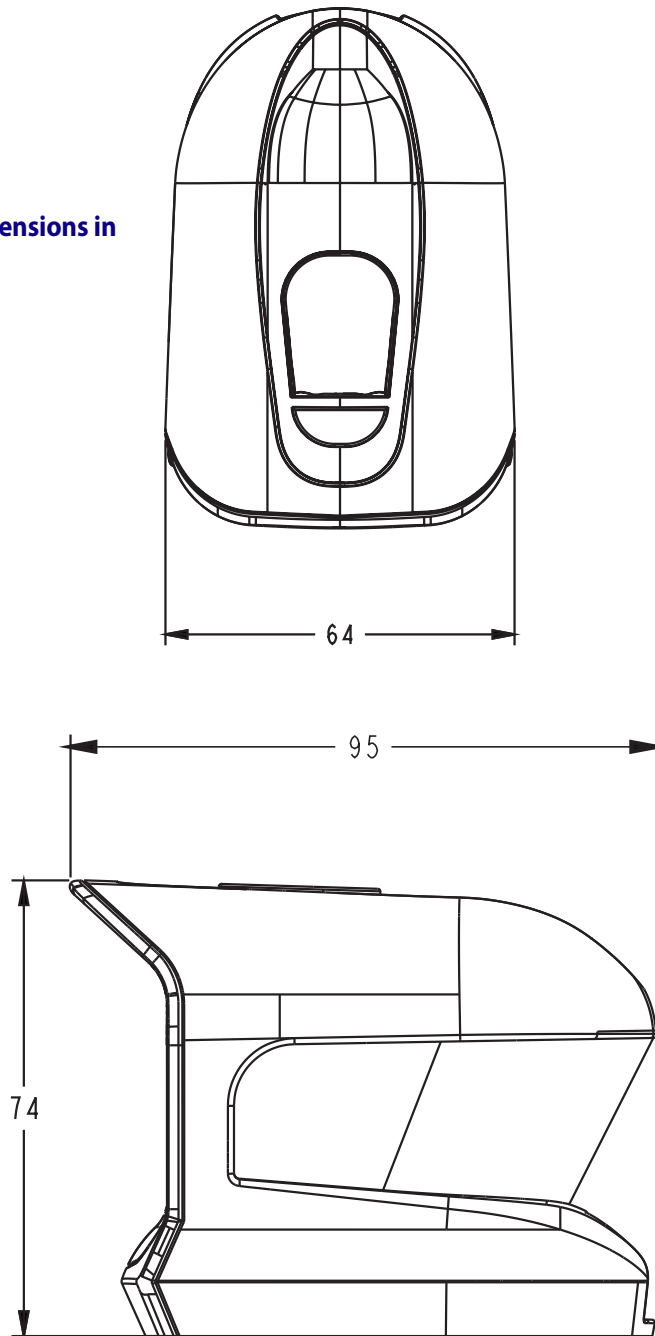
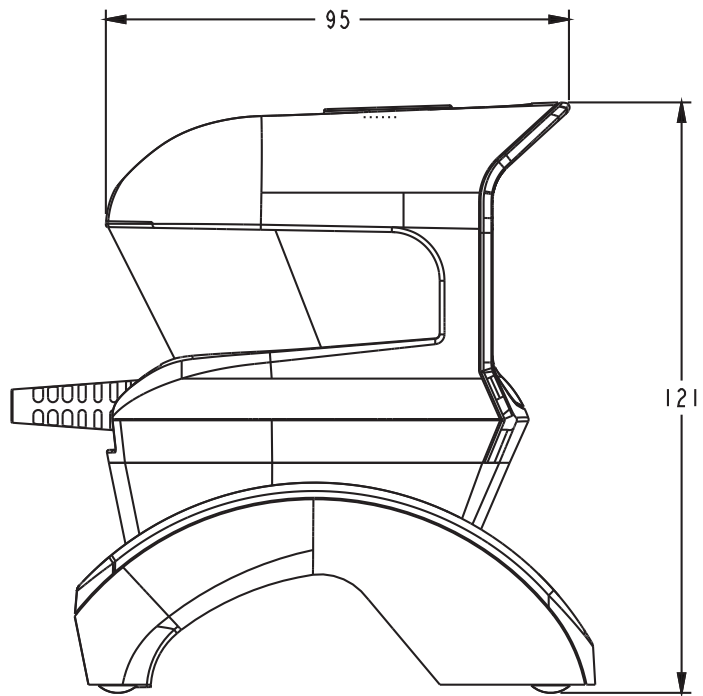
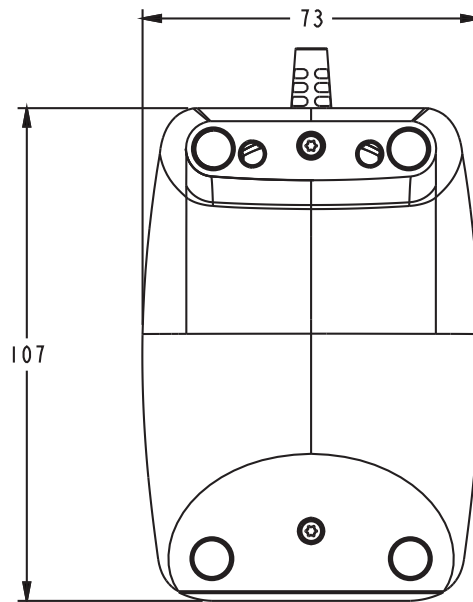

Figure 8. GPS4400 Dimensions With Stand



**Dimensions in
mm**



Imager Labeling

The sample labels shown below are for illustrative purposes only. Please view the labels on your product for actual details, as they may vary.

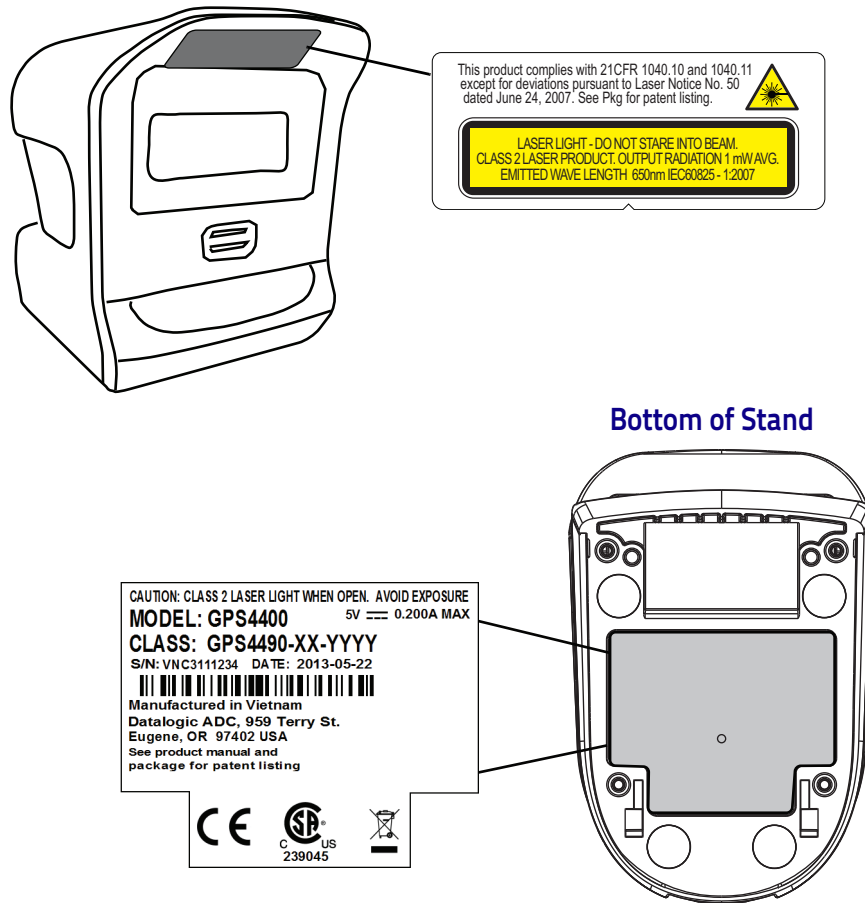

Aiming System

The Gryphon™ aiming system meets the Class 2 requirements for laser safety.

NOTES



Appendix B Standard Defaults

The most common configuration settings are listed in the “Default” column of the table below. Page references are also provided for feature descriptions and programming bar codes for each parameter. A column has also been provided for recording your preferred default settings for these same configurable features.



This section shows standard defaults. If your reader was provided with a custom configuration, your defaults may differ from those shown.

Table 42. Standard Defaults

Parameter	Default	Your Setting	Page Number
GLOBAL INTERFACE FEATURES			
Host Commands — Obey/Ignore	Obey		15
RS-232 ONLY			
Baud Rate	9600		18
Data Bits	8 Data Bits		19
Stop Bits	1 Stop Bit		19
Parity	None		20
Handshaking Control	RTS		21
RS-232/USB-COM			
Intercharacter Delay	No Delay		23
Beep On ASCII BEL	Disable		23
Beep On Not on File	Enable		24
ACK NAK Options	Disable		24
ACK Character	'ACK'		25

Parameter	Default	Your Setting	Page Number
NAK Character	'NAK'		25
ACK NAK Timeout Value	200 ms		26
ACK NAK Retry Count	3 Retries		26
ACK NAK Error Handling	Ignore Errors Detected		27
Indicate Transmission Failure	Enable		27
Disable Character	'D'		28
Enable Character	'E'		28
USB KEYBOARD			
Country Mode	U.S. Keyboard		30
Send Control Characters	00		34
Intercode Delay	100 ms		35
Intercode Delay	No Delay		35
USB Keyboard Speed	1 ms		36
USB Keyboard Numeric Keypad	Standard Keys		37
USB-OEM			
USB-OEM Device Usage	Handheld		40
Transmit Labels in Code 39 Format	IBM Standard Format		41
Interface Options	Ignore Scanner Configuration Host Commands		41
DATA FORMAT			
Global Prefix/Suffix	No Global Prefix Global Suffix = 0x0D (CR)		44
Global AIM ID	Disable		45
Set AIM ID Individually for GS1-128	Enable		47
Label ID: Pre-Loaded Sets	USA Set		48
Individually Set Label ID	Disable		49
No Read String	0x18 = (CAN)		55
Code Verifier Mode	Disable		56
Match String	Disable		57
Wrong Code String	Disable		57

Parameter	Default	Your Setting	Page Number
Label Transmit Mode	Disable		58
Advanced Formatting: User Label Edit	Disable		58
Case Conversion	Disable		59
Character Conversion	No Char Conversion		59
READING PARAMETERS			
Double Read Timeout	1 Second		61
Power On Alert	Power-up Beep		63
Good Read: When to Indicate	After Decode		63
Good Read Beep Type	Mono		64
Good Read Beep Frequency	Medium		64
Good Read Beep Length	80 ms		65
Good Read Beep Volume	High		66
Good Read LED Duration	300 ms		67
Scanning Features			
Operating Mode	On Line		68
Phase Off Event	Trigger Stop		69
Phase Off Timeout	5 = Timeout set for 5 seconds		69
Serial Start Character	0x02 = Serial Start Character is [02 STX]		70
Serial Stop Character	0x03 = Serial Stop Character is [03 ETX]		70
Manual Trigger Control	Disable		71
Central Code Only	Disable		71
Scanning Active Time	5 Seconds		72
Presentation Illumination Control	Off		72
Aiming Pointer	Enable		73
Aiming Duration Timer	Aiming Off After Decoding		73
Green Spot Duration	300 ms		74
Mobile Phone Mode	Enable		74

Parameter	Default	Your Setting	Page Number
Mobile Bias	No Mobile Bias		75
Partial Label Reading Control	Enable		75
Decode Negative Image	Disable		76
Multiple Label Reading			
Multiple Labels per Frame	Disable		77
Multiple Labels Ordering by Code Symbolology	Random Order		78
Multiple Labels Ordering by Code Length	Disable		78
CODE SELECTION - 1D SYMBOLOGIES			
Code EAN/UPC			
Coupon Control	Enable only UPCA coupon decoding		81
UPC-A			
UPC-A Enable/Disable	Enable		82
UPC-A Check Character Transmission	Send		82
Expand UPC-A to EAN-13	Don't Expand		83
UPC-A Number System Character Transmission	Transmit		83
UPC-A 2D Component	2D Component Not Required		84
UPC-E			
UPC-E Enable/Disable	Enable		84
UPC-E Check Character Transmission	Send		85
UPC-E 2D Component	2D Component Not Required		85
Expand UPC-E to EAN-13	Don't Expand		86
Expand UPC-E to UPC-A	Don't Expand		86
UPC-E Number System Character Transmission	Transmit		87
GTIN			
GTIN Formatting	Disable		87

Parameter	Default	Your Setting	Page Number
EAN 13 (Jan 13)			
EAN 13 Enable/Disable	Enable		88
EAN 13 Check Character Transmission	Send		88
EAN-13 Flag 1 Character	Transmit		89
EAN-13 ISBN Conversion	Disable		89
EAN-13 2D Component	2D Component Not Required		90
ISSN			
ISSN Enable/Disable	Disable		90
EAN 8			
EAN 8 Enable/Disable	Enable		91
EAN 8 Check Character Transmission	Send		91
Expand EAN 8 to EAN 13	Disable		92
EAN 8 2D Component	2D Component Not Required		92
UPC/EAN Global Settings			
UPC/EAN Price Weight Check	Disable		93
UPC/EAN Quiet Zones	Two Modules		94
Add-Ons			
Optional Add-ons	Disable P2, P5 and P8		95
Optional Add-On Timer	70 ms		96
Optional GS1-128 Add-On Timer	Disable		99
Code 39			
Code 39 Enable/Disable	Enable		102
Code 39 Check Character Calculation	Calculate Std Check		102
Code 39 Check Character Transmission	Send		103
Code 39 Start/Stop Character Transmission	Don't Transmit		104
Code 39 Full ASCII	Disable		104
Code 39 Quiet Zones	Small Quiet Zones on two sides		105

Parameter	Default	Your Setting	Page Number
Code 39 Length Control	Variable		105
Code 39 Set Length 1	2		106
Code 39 Set Length 2	50		107
Trioptic Code			
Trioptic Code Enable/Disable	Disable		108
Code 32 (Italian Pharmaceutical Code)			
Code 32 Enable/Disable	Disable		108
Code 32 Check Char Transmission	Don't Send		109
Code 32 Start/Stop Character Transmission	Don't Transmit		109
Code 39 CIP (French Pharmaceutical Code)			
Code 39 CIP Enable/Disable	Disable		110
Special Codes			
Code 39 Danish PPT Enable/Disable	Disable		110
Code 39 LaPoste Enable/Disable	Disable		111
Code 39 PZN Enable/Disable	Disable		111
Code 128			
Code 128 Enable/Disable	Enable		112
Expand Code 128 to Code 39	Don't Expand		112
Code 128 Check Character Transmission	Don't Send		113
Code 128 Function Character Transmission	Don't Send		113
Code 128 Sub-Code Exchange Transmission	Disable		114
Code 128 Quiet Zones	Small Quiet Zones on two sides		114
Code 128 Length Control	Variable		115
Code 128 Set Length 1	1		116
Code 128 Set Length 2	80		117
GS1-128			
GS1-128 Enable	Transmit in Code 128 Data Format		118

Parameter	Default	Your Setting	Page Number
GS1-128 2D Component	Disable		118
ISBT 128			
ISBT 128 Concatenation	Disable		119
ISBT 128 Force Concatenation	Disable		119
ISBT 128 Concatenation Mode	Static		120
ISBT 128 Dynamic Concatenation Timeout	200 msec		121
Interleaved 2 of 5			
I 2 of 5 Enable/Disable	Disable		122
I 2 of 5 Check Character Calculation	Disable		123
I 2 of 5 Check Character Transmission	Send		124
I 2 of 5 Length Control	Variable		124
I 2 of 5 Set Length 1	6		125
I 2 of 5 Set Length 2	50		126
Interleaved 2 of 5 CIP HR			
Interleaved 2 of 5 CIP HR Enable/Disable	Disable		127
Follett 2 of 5			
Follett 2 of 5 Enable/Disable	Disable		127
Standard 2 of 5			
Standard 2 of 5 Enable/Disable	Disable		128
Standard 2 of 5 Check Character Calculation	Disable		128
Standard 2 of 5 Check Character Transmission	Send		129
Standard 2 of 5 Length Control	Variable		129
Standard 2 of 5 Set Length 1	8		130
Standard 2 of 5 Set Length 2	50		131
Industrial 2 of 5			
Industrial 2 of 5 Enable/Disable	Disable		132
Industrial 2 of 5 Check Character Calculation	Disable		132

Parameter	Default	Your Setting	Page Number
Industrial 2 of 5 Check Character Transmission	Enable		133
Industrial 2 of 5 Length Control	Variable		133
Industrial 2 of 5 Set Length 1	1		134
Industrial 2 of 5 Set Length 2	50		135
Code IATA			
IATA Enable/Disable	Disable		136
IATA Check Character Transmission	Enable		136
Codabar			
Codabar Enable/Disable	Disable		137
Codabar Check Character Calculation	Don't Calculate		137
Codabar Check Character Transmission	Send		138
Codabar Start/Stop Character Transmission	Transmit		138
Codabar Start/Stop Character Set	abcd/abcd		139
Codabar Start/Stop Character Match	Don't Require Match		139
Codabar Quiet Zones	Small Quiet Zones on two sides		140
Codabar Length Control	Variable		140
Codabar Set Length 1	3		141
Codabar Set Length 2	50		142
ABC Codabar			
ABC Codabar Enable/Disable	Disable		143
ABC Codabar Concatenation Mode	Static		143
ABC Codabar Dynamic Concatenation Timeout	200 msec		144
ABC Codabar Force Concatenation	Disable		145
Code 11			
Code 11 Enable/Disable	Disable		146
Code 11 Check Character Calculation	Check C and K		146
Code 11 Check Character Transmission	Send		147

Parameter	Default	Your Setting	Page Number
Code 11 Length Control	Variable		147
Code 11 Set Length 1	4		148
Code 11 Set Length 2	50		149
GS1 DataBar™ Omnidirectional			
GS1 DataBar™ Omnidirectional Enable/Disable	Disable		150
GS1 DataBar™ Omnidirectional GS1-128 Emulation	Disable		150
GS1 DataBar™ Omnidirectional 2D Component	2D component not required		151
GS1 DataBar™ Expanded			
GS1 DataBar™ Expanded Enable/Disable	Disable		151
GS1 DataBar™ Expanded GS1-128 Emulation	Disable		152
GS1 DataBar™ Expanded 2D Component	2D component not required		152
GS1 DataBar™ Expanded Length Control	Variable		153
GS1 DataBar™ Expanded Set Length 1	1		154
GS1 DataBar™ Expanded Set Length 2	74		155
GS1 DataBar™ Limited			
GS1 DataBar™ Limited Enable/Disable	Disable		156
GS1 DataBar™ Limited GS1-128 Emulation	Disable		156
GS1 DataBar™ Limited 2D Component	2D component not required		157
Code 93			
Code 93 Enable/Disable	Disable		157
Code 93 Check Character Calculation	Enable Check C and K		158
Code 93 Check Character Transmission	Enable		158
Code 93 Length Control	Variable		159
Code 93 Set Length 1	1		160
Code 93 Set Length 2	50		161

Standard Defaults

Parameter	Default	Your Setting	Page Number
Code 93 Quiet Zones	Small Quiet Zones on two sides		162
MSI			
MSI Enable/Disable	Disable		162
MSI Check Character Calculation	Enable Mod10		163
MSI Check Character Transmission	Enable		163
MSI Length Control	Variable		165
MSI Set Length 1	1		165
MSI Set Length 2	50		166
Plessey			
Plessey Enable/Disable	Disable		167
Plessey Check Character Calculation	Enable Plessey std. check char. verification		167
Plessey Check Character Transmission	Enable		168
Plessey Length Control	Variable		168
Plessey Set Length 1	1		169
Plessey Set Length 2	50		170

Parameter	Default	Your Setting	Page Number
CODE SELECTION - 2D SYMBOLOGIES			
2D Global Features			
2D Maximum Decoding Time	350msec		172
2D Structured Append	Disable		173
2D Normal/Inverse Symbol Control	Normal		174
AztecCode			
Aztec Code Enable / Disable	Enable		175
Aztec Code Length Control	Enable		175
Aztec Code Length Control	Variable		175
Aztec Code Set Length 1	1		176
China Sensible Code			
China Sensible Code Enable / Disable	Disable		178
China Sensible Code Length Control	Variable		178
China Sensible Code Set Length 1	1		179
China Sensible Code Set Length 2	7,827		180
Data Matrix			
Data Matrix Enable / Disable	Enable		181
Data Matrix Square/Rectangular Style	Both Square and Rectangular style		181
Data Matrix Length Control	Variable		182
Data Matrix Set Length 1	1		182
Data Matrix Set Length 2	3,116		183
Maxicode			
Maxicode Enable / Disable	Disable		184
Maxicode Primary Message Transmission	Disable		184
Maxicode Length Control	Variable		185
Maxicode Set Length 1	1		185
Maxicode Set Length 2	0145		186
PDF417			

Standard Defaults

Parameter	Default	Your Setting	Page Number
PDF417 Enable / Disable	Enable		187
PDF417 Length Control	Variable		187
PDF417 Set Length 1	1		188
PDF417 Set Length 2	2,710		189
Micro PDF417			
Micro PDF417 Enable / Disable	Disable		190
Micro PDF417 Code 128 GS1-128 Emulation	Micro PDF AIM ID and label type		190
Micro PDF417 Length Control	Variable		191
Micro PDF417 Set Length 1	1		191
Micro PDF417 Set Length 2	0366		192
QR Code			
QR Code Enable / Disable	Enable		193
QR Code Length Control	Variable		193
QR Code Set Length 1	1		194
QR Code Set Length 2	7,089		195
Micro QR Code			
Micro QR Code Enable/Disable	Disable		196
Micro QR Code Length Control	Variable		196
Micro QR Code Set Length 1	0001		197
Micro QR Code Set Length 2	0035		198
UCC Composite			
UCC Composite Enable / Disable	Disable		199
UCC Optional Composite Timer	Timer Disabled		200
Postal Codes			
Postal Code Selection	Disable all Postal codes		201
Postnet BB Control	Disable		202



Appendix C

Sample Bar Codes

The sample bar codes in this appendix are typical representations for their symbology types.

1D Bar Codes

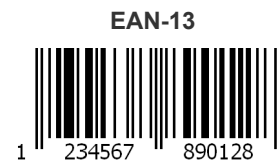

1D Bar Codes (continued)

Code 32



Codabar



Code 93



Code 11



GS1 DataBar™



GS1 DataBar™ variants must be enabled to read the bar codes below (see "GS1 DataBar™ Omnidirectional" on page 150).

GS1 DataBar™ 14



GS1 DataBar™ Expanded



GS1 DataBar™ Limited



GS1 DataBar™ Truncated



GS1 DataBar™ Stacked



GS1 DataBar™ Omnidirectional Stacked



GS1 DataBar™ Expanded Stacked



2D Bar Codes

Aztec



ABCabc

Datamatrix



ABCabc

China Sensible Code



12345678

PDF 417



ABCabc

QR Code



ABCabc

MaxiCode

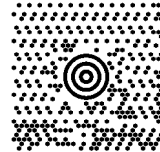

ABCabc

Micro PDF 417



12345678

Micro QR Code



ABCDEF

Composite Codes

DataBar™ Expanded Stacked Composite

(17) 050923
(10) ABC123
(21) 2153641167



(04) 01234567890

GS1-128 Composite

(17) 050923 (10) ABC123



(01) 0 4012345 67890 1 1



Appendix D Keypad

Use the bar codes in this appendix to enter numbers as you would select digits/characters from a keypad.



0



1

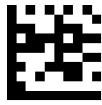

2



3



4



5



6



7



8



9

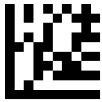

A



B



C



D



E

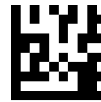

F



Appendix E

Host Configuration Reserved Characters

Reserved Characters	Hex Value	Notes
[SOH]	0x01	
[BEL]	0x07	
#	0x23	
\$	0x24	
0	0x30	
3	0x33	
B	0x42	
D	0x44	
E	0x45	
F	0x46	
R	0x52	
S	0x53	
h	0x68	
i	0x69	
s	0x73	
t	0x74	
[FF]	0xFF	
Reserved Strings		
C<up to 36 chars>[CR]	0x43 <xxx> 0x0D	C can be used without [CR] or inside a string (not the first character)
01[CR]	0x30 0x31 0x0D	
34[CR]	0x33 0x34 0x0D	

NOTES



Appendix F

Scancode Tables

Control Character Emulation

Control character emulation selects from different scancode tables as listed in this appendix. Each of the control character sets below are detailed by interface type in the tables. These apply to USB Keyboard platforms.

Control Character 00 : Characters from 00 to 0x1F are sent as control character Ctrl+Keys, special keys are located from 0x80 to 0xA1.

Control Character 01 : Characters from 00 to 0x1F are sent as control character Ctrl+Capital Key, special keys are located from 0x80 to 0xA1.

Control Character 02 : Special keys are located from 00 to 0x1F and characters from 0x80 to 0xFE are intended as an extended ASCII table (Microsoft Windows Codepage 1252 —see [page 300](#))

Single Press and Release Keys

In the following tables, Ar↓ means Alt right pressed and Ar↑ means Alt right released, and so on. Definitions for other keys are Al (Alt left), Cr (Control Right) Cl (Control Left) Sh (shift). This method can be used for combining Alt, Control or Shift with other keys.

Example: Consider a Control character set to 00. If AltRight+A is required before sending a label to the host, it could be done by setting three Prefix keys in this way: 0x99 0x41 0x9A.

Interface Type PC AT PS/2, USB-Keyboard or USB-Keyboard for APPLE

Table 43. Scancode Set When Control Character is 00 or 01

	x0	x1	x2	x3	x4	x5	x6	x7	x8	x9	xA	xB	xC	xD	xE	xF
0x	NULL C+@	SOH C(S)+A	STX C(S)+B	ETX C(S)+C	EOT C(S)+D	ENQ C(S)+E	ACK C(S)+F	BEL C(S)+G	BS C(S)+H	HT TAB	LF C(S)+J	VT C(S)+K	FF C(S)+L	CR Enter	SO C(S)+N	SI C(S)+O
1x	DLE C(S)+P	DC1 C(S)+Q	DC2 C(S)+R	DC3 C(S)+S	DC4 C(S)+T	NAK C(S)+U	SYN C(S)+V	ETB C(S)+W	CAN C(S)+X	EM C(S)+Y	SUB C(S)+Z	ESC Esc	FS C+\	GS C+]	RS C+^	US C(S)+_
2x	<u>SP</u>	!	"	#	\$	%	&	'	()	*	±	.	=	-	/
3x	0	1	2	3	4	5	6	7	8	9	:	;	<=	=	>=	?
4x	@	A	B	C	D	E	F	G	H	I	J	K	L	M	N	O
5x	P	Q	R	S	T	U	V	W	X	Y	Z	[\]	^	_
6x	`	a	b	c	d	e	f	g	h	i	j	k	l	m	n	o
7x	p	q	r	s	t	u	v	w	x	y	z	{		}	~	Del
8x	€	Sh↓	Sh↑	Ins	Ent (keyp)	F1	F2	F3	F4	F5	F6	F7	F8	F9	F10	F11
9x	F12	Home	End	Pg Up	Pg Dwn	↑	↓	←	→	Ar↓	Ar↑	Al↓	Al↑	Cl↓	Cl↑	Cr↓
Ax	Cr↑		‘	f	„	...	†	‡	^	%	Š	<	Š	<	Œ	
Bx	°	±	²	³	´	µ	¶	·	,	¹	º	»	¼	½	¾	¿
Cx	À	Á	Â	Ã	Ä	Å	Æ	Ç	È	É	Ê	Ë	Ì	Í	Î	Ï
Dx	Ð		Ò	Ó	Ô	Õ	Ö	×	Ø	Ù	Ú	Û	Ü	Ý	Þ	ß
Ex	à	á	â	ã	ä	å	æ	ç	è	é	ê	ë	ì	í	î	ï
Fx	ð	ñ	ò	ó	ô	õ	ö	÷	ø	ù	ú	û	ü	ý	þ	ÿ

Extended characters (sky blue) are sent through dedicated keys (when available in the selected country mode) or by using an Alt Mode sequence.

Interface Type PC AT PS/2, USB-Keyboard or USB-Keyboard for APPLE (continued)

Table 44. Scancode Set When Control Character is 02

	x0	x1	x2	x3	x4	x5	X6	x7	x8	x9	xA	xB	xC	xD	xE	xF
0x	Ar↓	Ar↑	Al↓	Al↑	Cl↓	Cl↑	Cr↓	Cr↑	BS	Tab	→	S+ Tab	Enter Keypd	Enter	Ins	Pg Up
1x	Pg Dwn	Home	←	↓	↑	F6	F1	F2	F3	F4	F5	ESC	F7	F8	F9	F10
2x	Space	!	“	#	\$	%	&	‘	()	*	+	,	-	.	/
3x	0	1	2	3	4	5	6	7	8	9	:	;	<	=	>	?
4x	@	A	B	C	D	E	F	G	H	I	J	K	L	M	N	O
5x	P	Q	R	S	T	U	V	W	X	Y	Z	[\]	^	_
6x	`	a	b	c	d	e	f	g	h	i	j	k	l	m	n	o
7x	p	q	r	s	t	u	v	w	x	y	z	{		}	~	Del
8x	€	‘	ƒ	„	…	†	‡	^	%	Š	<	Š	<	Œ		
9x		‘	’	“	”	•	–	—	~	™	š	>	œ		ž	ÿ
Ax	NBSP	ı	¢	£	¤	¥	¦	§	¨	©	ª	«	¬	-	®	¯
Bx	°	±	²	³	´	µ	¶	·	,	¹	º	»	¼	½	¾	¿
Cx	À	Á	Â	Ã	Ä	Å	Æ	Ç	È	É	Ê	Ë	Ì	Í	Î	Ï
Dx	Ð		Ò	Ó	Ô	Õ	Ö	×	Ø	Ù	Ú	Û	Ü	Ý	Þ	ß
Ex	à	á	â	ã	ä	å	æ	ç	è	é	ê	ë	ì	í	î	ï
Fx	ð	ñ	ò	ó	ô	õ	ö	÷	ø	ù	ú	û	ü	ý	þ	ÿ

Interface type PC AT PS/2 Alt Mode or USB-Keyboard Alt Mode

Table 45. Scancode Set When Control Character is 00 or 01

	x0	x1	x2	x3	x4	x5	X6	x7	x8	x9	xA	xB	xC	xD	xE	Xf
0x	Alt+000	Alt+001	Alt+002	Alt+003	Alt+004	Alt+005	Alt+006	Alt+007	BS	HT TAB	Alt+010	Alt+011	Alt+012	CR Enter	Alt+014	Alt+015
1x	Alt+016	Alt+017	Alt+018	Alt+019	Alt+020	Alt+021	Alt+022	Alt+023	Alt+024	Alt+025	Alt+026	ESC Esc	Alt+028	Alt+029	Alt+030	Alt+031
2x	A+032	A+033	A+034	A+035	A+036	A+037	A+038	A+039	A+040	A+041	A+042	A+043	A+044	A+045	A+046	A+047
3x	A+048	A+049	A+050	A+051	A+052	A+053	A+054	A+055	A+056	A+057	A+058	A+059	A+060	A+061	A+062	A+063
4x	A+064	A+065	A+066	A+067	A+068	A+069	A+070	A+071	A+072	A+073	A+074	A+075	A+076	A+077	A+078	A+079
5x	A+080	A+081	A+082	A+083	A+084	A+085	A+086	A+087	A+088	A+089	A+090	A+091	A+092	A+093	A+094	A+095
6x	A+096	A+097	A+098	A+099	A+100	A+101	A+102	A+103	A+104	A+105	A+106	A+107	A+108	A+109	A+110	A+111
7x	A+112	A+113	A+114	A+115	A+116	A+117	A+118	A+119	A+120	A+121	A+122	A+123	A+124	A+125	A+126	A+127
8x	€	Sh↓	Sh↑	Ins	Ent (keyp)	F1	F2	F3	F4	F5	F6	F7	F8	F9	F10	F11
9x	F12	Home	End	Pg Up	Pg Dwn	↑	↓	←	→	Ar↓	Ar↑	Al↓	Al↑	Cl↓	Cl↑	Cr↓
Ax	Cr↑	A+0161	A+0162	A+0163	A+0164	A+0165	A+0166	A+0167	A+0168	A+0169	A+0170	A+0171	A+0172	A+0173	A+0174	A+0175
Bx	A+0176	A+0177	A+0178	A+0179	A+0180	A+0181	A+0182	A+0183	A+0184	A+0185	A+0186	A+0187	A+0188	A+0189	A+0190	A+0191
Cx	A+0192	A+0193	A+0194	A+0195	A+0196	A+0197	A+0198	A+0199	A+0200	A+0201	A+0202	A+0203	A+0204	A+0205	A+0206	A+0207
Dx	A+0208	A+0209	A+0210	A+0211	A+0212	A+0213	A+0214	A+0215	A+0216	A+0217	A+0218	A+0219	A+0220	A+0221	A+0222	A+0223
Ex	A+0224	A+0225	A+0226	A+0227	A+0228	A+0229	A+0230	A+0231	A+0232	A+0233	A+0234	A+0235	A+0236	A+0237	A+0238	A+0239
Fx	A+0240	A+0241	A+0242	A+0243	A+0244	A+0245	A+0246	A+0247	A+0248	A+0249	A+0250	A+0251	A+0252	A+0253	A+0254	A+0255

Interface type PC AT PS/2 Alt Mode or USB-Keyboard Alt Mode (continued)

Table 46. Scancode Set When Control Character is 02

	x0	x1	x2	x3	x4	x5	X6	x7	x8	x9	xA	xB	xC	xD	xE	xF
0x	Ar↓	Ar↑	Al↓	Al↑	Cl↓	Cl↑	Cr↓	Cr↑	BS	Tab	→	S+ Tab	Enter Keyprd	Enter	Ins	Pg Up
1x	Pg Dwn	Home	←	↓	↑	F6	F1	F2	F3	F4	F5	ESC	F7	F8	F9	F10
2x	A+032	A+033	A+034	A+035	A+036	A+037	A+038	A+039	A+040	A+041	A+042	A+043	A+044	A+045	A+046	A+047
3x	A+048	A+049	A+050	A+051	A+052	A+053	A+054	A+055	A+056	A+057	A+058	A+059	A+060	A+061	A+062	A+063
4x	A+064	A+065	A+066	A+067	A+068	A+069	A+070	A+071	A+072	A+073	A+074	A+075	A+076	A+077	A+078	A+079
5x	A+080	A+081	A+082	A+083	A+084	A+085	A+086	A+087	A+088	A+089	A+090	A+091	A+092	A+093	A+094	A+095
6x	A+096	A+097	A+098	A+099	A+100	A+101	A+102	A+103	A+104	A+105	A+106	A+107	A+108	A+109	A+110	A+111
7x	A+112	A+113	A+114	A+115	A+116	A+117	A+118	A+119	A+120	A+121	A+122	A+123	A+124	A+125	A+126	A+127
8x	A+0128	A+0129	A+0130	A+0131	A+0132	A+0133	A+0134	A+0135	A+0136	A+0137	A+0138	A+0139	A+0140	A+0141	A+0142	A+0143
9x	A+0144	A+0145	A+0146	A+0147	A+0148	A+0149	A+0150	A+0151	A+0152	A+0153	A+0154	A+0155	A+0156	A+0157	A+0158	A+0159
Ax	A+0160	A+0161	A+0162	A+0163	A+0164	A+0165	A+0166	A+0167	A+0168	A+0169	A+0170	A+0171	A+0172	A+0173	A+0174	A+0175
Bx	A+0176	A+0177	A+0178	A+0179	A+0180	A+0181	A+0182	A+0183	A+0184	A+0185	A+0186	A+0187	A+0188	A+0189	A+0190	A+0191
Cx	A+0192	A+0193	A+0194	A+0195	A+0196	A+0197	A+0198	A+0199	A+0200	A+0201	A+0202	A+0203	A+0204	A+0205	A+0206	A+0207
Dx	A+0208	A+0209	A+0210	A+0211	A+0212	A+0213	A+0214	A+0215	A+0216	A+0217	A+0218	A+0219	A+0220	A+0221	A+0222	A+0223
Ex	A+0224	A+0225	A+0226	A+0227	A+0228	A+0229	A+0230	A+0231	A+0232	A+0233	A+0234	A+0235	A+0236	A+0237	A+0238	A+0239
Fx	A+0240	A+0241	A+0242	A+0243	A+0244	A+0245	A+0246	A+0247	A+0248	A+0249	A+0250	A+0251	A+0252	A+0253	A+0254	A+0255

Digital Interface

Table 47. Scancode Set When Control Character is 00 or 01

	X0	x1	x2	x3	x4	x5	x6	x7	x8	x9	xA	xB	xC	xD	xE	xF
0x	NULL C+@	SOH C(S)+A	STX C(S)+B	ETX C(S)+C	EOT C+D	ENQ C(S)+E	ACK C(S)+F	BEL C(S)+G	BS	HT TAB	LF C(S)+J	VT C(S)+K	FF C(S)+L	CR Enter	SO C(S)+N	SI C(S)+O
1x	DLE C(S)+P	DC1 C(S)+Q	DC2 C(S)+R	DC3 C(S)+S	DC4 C(S)+T	NAK C(S)+U	SYN C(S)+V	ETB C(S)+W	CAN C(S)+X	EM C(S)+Y	SUB C(S)+Z	ESC Esc	FS C(S)+\	GS C+]	RS C(S)+^	US C(S)+_
2x	Space	!	“	#	\$	%	&	‘	()	*	+	,	-	.	/
3x	0	1	2	3	4	5	6	7	8	9	:	;	<	=	>	?
4x	@	A	B	C	D	E	F	G	H	I	J	K	L	M	N	O
5x	P	Q	R	S	T	U	V	W	X	Y	Z	[\]	^	_
6x	`	a	b	c	d	e	f	g	h	i	j	k	l	m	n	o
7x	p	q	r	s	t	u	v	w	x	y	z	{		}	~	Del
8x		Sh↓	Sh↑	Ins	Ent (keyp)	F1	F2	F3	F4	F5	F6	F7	F8	F9	F10	F11
9x	F12	F13	F14	F15	F16	↑	↓	←	→					Cl ↓	Cl ↑	

Table 48. Scancode Set When Control Character is 02

	X0	x1	x2	x3	x4	x5	x6	x7	x8	x9	xA	xB	xC	xD	xE	xF
0x					Cl ↓	Cl ↑			BS	Tab	à	S+ Tab	Enter Keyprd	Enter	Ins	
1x			←	↓	↑	F6	F1	F2	F3	F4	F5	ESC	F7	F8	F9	F10
2x	Space	!	“	#	\$	%	&	‘	()	*	+	,	-	.	/
3x	0	1	2	3	4	5	6	7	8	9	:	;	<	=	>	?
4x	@	A	B	C	D	E	F	G	H	I	J	K	L	M	N	O
5x	P	Q	R	S	T	U	V	W	X	Y	Z	[\]	^	_
6x	`	a	b	c	d	e	f	g	h	i	j	k	l	m	n	o
7x	p	q	r	s	t	u	v	w	x	y	z	{		}	~	Del

IBM31xx 102-key

Table 49. Scancode Set When Control Character is 00 or 01

	X0	x1	x2	x3	x4	x5	x6	x7	x8	x9	xA	xB	xC	xD	xE	xF
0x	NULL C+@	SOH C(S)+A	STX C(S)+B	ETX C(S)+C	EOT C+D	ENQ C(S)+E	ACK C(S)+F	BEL C(S)+G	BS	HT TAB	LF C(S)+J	VT C(S)+K	FF C(S)+L	CR Enter	SO C(S)+N	SI C(S)+O
1x	DLE C(S)+P	DC1 C(S)+Q	DC2 C(S)+R	DC3 C(S)+S	DC4 C(S)+T	NAK C(S)+U	SYN C(S)+V	ETB C(S)+W	CAN C(S)+X	EM C(S)+Y	SUB C(S)+Z	ESC Esc	FS C(S)+\	GS C+]	RS C(S)+^	US C(S)+_
2x	Space	!	“	#	\$	%	&	‘	()	*	+	,	-	.	/
3x	0	1	2	3	4	5	6	7	8	9	:	;	<	=	>	?
4x	@	A	B	C	D	E	F	G	H	I	J	K	L	M	N	O
5x	P	Q	R	S	T	U	V	W	X	Y	Z	[\]	^	_
6x	‘	a	B	c	d	e	f	g	h	i	j	k	l	m	n	o
7x	p	q	R	s	t	u	v	w	x	y	z	{		}		Del
8x		Sh↓	Sh↑	Ins	Ent (keyp)	F1	F2	F3	F4	F5	F6	F7	F8	F9	F10	F11
9x	F12	Enter	Reset	Insert	Delete	Field -	Field +	Enter paddle	Printl	Ar↓	Ar↑	Al↓	Al↑	Cl↓	Cl↑	Cr↓
Ax	Cr↑															

Table 50. Scancode Set When Control Character is 02

	X0	x1	x2	x3	x4	x5	x6	x7	x8	x9	xA	xB	xC	xD	xE	xF
0x	Ar↓	Ar↑	Al↓	Al↑	Cl↓	Cl↑	Cr↓	Cr↑	BS	Tab	→	S+ Tab	Enter Keypd	Enter	Ins	Pg Up
1x	Pg Dwn	Home	←	↓	↑	F6	F1	F2	F3	F4	F5	ESC	F7	F8	F9	F10
2x	Space	!	“	#	\$	%	&	‘	()	*	+	,	-	.	/
3x	0	1	2	3	4	5	6	7	8	9	:	;	<	=	>	?
4x	@	A	B	C	D	E	F	G	H	I	J	K	L	M	N	O
5x	P	Q	R	S	T	U	V	W	X	Y	Z	[\]	^	_
6x	‘	a	B	c	d	e	f	g	h	i	j	k	l	m	n	o
7x	p	q	R	s	t	u	v	w	x	y	z	{		}		Del

IBM XT

Table 51. Scancode Set When Control Character is 00 or 01

	X0	x1	x2	x3	x4	x5	x6	x7	x8	x9	xA	xB	xC	xD	xE	xF
0x	NULL C+@	SOH C(S)+A	STX C(S)+B	ETX C(S)+C	EOT C+D	ENQ C(S)+E	ACK C(S)+F	BEL C(S)+G	BS C(S)+H	HT TAB	LF C(S)+J	VT C(S)+K	FF C(S)+L	CR Enter	SO C(S)+N	SI C(S)+O
1x	DLE C(S)+P	DC1 C(S)+Q	DC2 C(S)+R	DC3 C(S)+S	DC4 C(S)+T	NAK C(S)+U	SYN C(S)+V	ETB C(S)+W	CAN C(S)+X	EM C(S)+Y	SUB C(S)+Z	ESC Esc	FS C(S)+\	GS C+]	RS C(S)+^	US C(S)+_
2x	Space	!	“	#	\$	%	&	‘	()	*	+	,	-	.	/
3x	0	1	2	3	4	5	6	7	8	9	:	;	<	=	>	?
4x	@	A	B	C	D	E	F	G	H	I	J	K	L	M	N	O
5x	P	Q	R	S	T	U	V	W	X	Y	Z	[\]	^	_
6x	‘	a	B	c	d	e	f	g	h	i	j	k	l	m	n	o
7x	p	q	R	s	t	u	v	w	x	y	z	{		}		Del
8x		Sh↓	Sh↑	Ins	Ent (keyp)	F1	F2	F3	F4	F5	F6	F7	F8	F9	F10	F11
9x	F12	Home	End	Pg Up	Pg Dwn	↑	↓	←	→	Ar↓	Ar↑	Al↓	Al↑	Cl↓	Cl↑	Cr↓
Ax	Cr↑															

Table 52. Scancode Set when Control Character 02

	X0	x1	x2	x3	x4	x5	x6	x7	x8	x9	xA	xB	xC	xD	xE	xF
0x	Ar↓	Ar↑	Al↓	Al↑	Cl↓	Cl↑	Cr↓	Cr↑	BS	Tab	→	S+ Tab	Enter Keyprd	Enter	Ins	Pg Up
1x	Pg Dwn	Home	←	↓	↑	F6	F1	F2	F3	F4	F5	ESC	F7	F8	F9	F10
2x	Space	!	“	#	\$	%	&	‘	()	*	+	,	-	.	/
3x	0	1	2	3	4	5	6	7	8	9	:	;	<	=	>	?
4x	@	A	B	C	D	E	F	G	H	I	J	K	L	M	N	O
5x	P	Q	R	S	T	U	V	W	X	Y	Z	[\]	^	_
6x	‘	a	B	c	d	e	f	g	h	i	j	k	l	m	n	o
7x	p	q	R	s	t	u	v	w	x	y	z	{		}		Del

Microsoft Windows Codepage 1252

Windows-1252 is a character encoding of the Latin alphabet, used by default in the legacy components of Microsoft Windows in English and some other Western languages.

	00	01	02	03	04	05	06	07	08	09	0A	0B	0C	0D	0E	0F
00	NUL 0000	STX 0001	SOT 0002	ETX 0003	EOT 0004	ENO 0005	ACK 0006	BEL 0007	BS 0008	HT 0009	LF 000A	VT 000B	FF 000C	CR 000D	SO 000E	SI 000F
10	DLE 0010	DC1 0011	DC2 0012	DC3 0013	DC4 0014	NAK 0015	SYN 0016	ETB 0017	CAN 0018	EM 0019	SUB 001A	ESC 001B	FS 001C	GS 001D	RS 001E	US 001F
20	SP 0020	! 0021	" 0022	# 0023	\$ 0024	% 0025	& 0026	* 0027	(0028) 0029	* 002A	+ 002B	, 002C	- 002D	. 002E	/ 002F
30	0 0030	1 0031	2 0032	3 0033	4 0034	5 0035	6 0036	7 0037	8 0038	9 0039	: 003A	; 003B	< 003C	= 003D	> 003E	? 003F
40	@ 0040	A 0041	B 0042	C 0043	D 0044	E 0045	F 0046	G 0047	H 0048	I 0049	J 004A	K 004B	L 004C	M 004D	N 004E	O 004F
50	P 0050	Q 0051	R 0052	S 0053	T 0054	U 0055	V 0056	W 0057	X 0058	Y 0059	Z 005A	[005B	\ 005C] 005D	^ 005E	_ 005F
60	` 0060	a 0061	b 0062	c 0063	d 0064	e 0065	f 0066	g 0067	h 0068	i 0069	j 006A	k 006B	l 006C	m 006D	n 006E	o 006F
70	p 0070	q 0071	r 0072	s 0073	t 0074	u 0075	v 0076	w 0077	x 0078	y 0079	z 007A	{ 007B	 007C	}	~ 007E	DEL 007F
80	€ 20AC	• 20A8	ƒ 201A	ſ 0192	ˆ 201E	˜ 2026	† 2020	‡ 2021	˘ 02C6	‰ 2030	Š 0160	‹ 2039	Œ 0152	• 017D	Ž 017D	• 017D
90	• 017D	ˆ 2018	˜ 2019	˘ 201C	˙ 201D	˚ 2022	˛ 2023	˜ 2014	˘ 02DC	˙ 2122	Š 0161	› 203A	œ 0153	• 017E	ž 017E	ÿ 0178
A0	NSP 00A0	ı 00A1	ı 00A2	ı 00A3	ı 00A4	ı 00A5	ı 00A6	ı 00A7	ı 00A8	ı 00A9	ı 00AA	ı 00AB	ı 00AC	ı 00AD	ı 00AE	ı 00AF
B0	• 00B0	± 00B1	± 00B2	± 00B3	± 00B4	± 00B5	± 00B6	± 00B7	± 00B8	± 00B9	± 00BA	± 00BB	± 00BC	± 00BD	± 00BE	± 00BF
C0	À 00C0	Á 00C1	Â 00C2	Ã 00C3	Ä 00C4	Å 00C5	Æ 00C6	Ç 00C7	È 00C8	É 00C9	Ê 00CA	Ë 00CB	Ì 00CC	Í 00CD	Î 00CE	Ï 00CF
D0	Ð 00D0	Ñ 00D1	Ò 00D2	Ó 00D3	Ô 00D4	Õ 00D5	Ö 00D6	× 00D7	Ø 00D8	Ù 00D9	Ú 00DA	Û 00DB	Ü 00DC	Ý 00DD	Þ 00DE	ß 00DF
E0	à 00E0	á 00E1	â 00E2	ã 00E3	ä 00E4	å 00E5	æ 00E6	ç 00E7	è 00E8	é 00E9	ê 00EA	ë 00EB	ì 00EC	í 00ED	î 00EE	ï 00EF
F0	ø 00F0	ñ 00F1	ò 00F2	ó 00F3	ô 00F4	õ 00F5	ö 00F6	÷ 00F7	ø 00F8	ù 00F9	ú 00FA	û 00FB	ü 00FC	ý 00FD	þ 00FE	ÿ 00FF

NOTES



Appendix G Screw Mounting Template

If desired, scan or detach this page to use as a template for mounting.
Shown actual size.

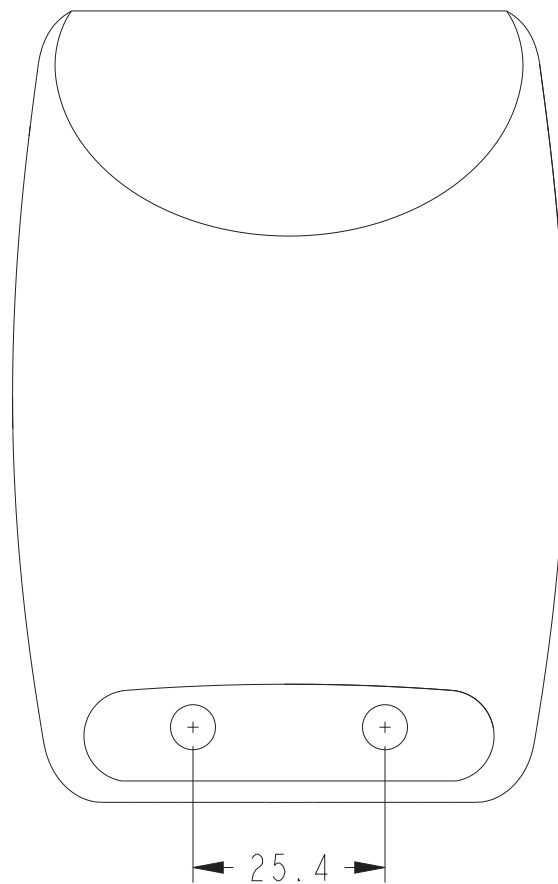

NOTES

ASCII Chart

ASCII Char.	Hex No.	ASCII Char.	Hex No.	ASCII Char.	Hex No.	ASCII Char.	Hex No.
NUL	00	SP	20	@	40	'	60
SOH	01	!	21	A	41	a	61
STX	02	"	22	B	42	b	62
ETX	03	#	23	C	43	c	63
EOT	04	\$	24	D	44	d	64
ENQ	05	%	25	E	45	e	65
ACK	06	&	26	F	46	f	66
BEL	07	'	27	G	47	g	67
BS	08	(28	H	48	h	68
HT	09)	29	I	49	i	69
LF	0A	*	2A	J	4A	j	6A
VT	0B	+	2B	K	4B	k	6B
FF	0C	,	2C	L	4C	l	6C
CR	0D	-	2D	M	4D	m	6D
SO	0E	.	2E	N	4E	n	6E
SI	0F	/	2F	O	4F	o	6F
DLE	10	0	30	P	50	p	70
DC1	11	1	31	Q	51	q	71
DC2	12	2	32	R	52	r	72
DC3	13	3	33	S	53	s	73
DC4	14	4	34	T	54	t	74
NAK	15	5	35	U	55	u	75
SYN	16	6	36	V	56	v	76
ETB	17	7	37	W	57	w	77
CAN	18	8	38	X	58	x	78
EM	19	9	39	Y	59	y	79
SUB	1A	:	3A	Z	5A	z	7A
ESC	1B	;	3B	[5B	{	7B
FS	1C	<	3C	\	5C		7C
GS	1D	=	3D]	5D	}	7D
RS	1E	>	3E	^	5E	~	7E
US	1F	?	3F	_	5F	DEL	7F



www.datalogic.com

©2013 Datalogic ADC, Inc. All rights reserved.
Datalogic and the Datalogic logo are registered trademarks of
Datalogic S.p.A. in many countries, including the U.S.A. and the E.U.

Datalogic ADC, Inc.

959 Terry Street | Eugene | OR 97402 | USA
Telephone: (1) 541-683-5700 | Fax: (1) 541-345-7140



820058614

(Rev B)

December 2013