



evolis
card printers

Zenius

USER GUIDE

Evolis Card Printer © 2013. All rights reserved. August 2014.

Ref. KU-ZEN1-038-ENG Rev. A1

Copyright

Evolis Card Printer © August 2014. All rights reserved.

Copyright notice

Users must observe the copyright regulations applicable in their country. This manual must not be photocopied, translated, reproduced or transmitted, in whole or in part, for any reason and by any electronic or mechanical means whatsoever without the express written consent of the Evolis Card Printer company.

All the information contained in this document is subject to change without prior notice.

Evolis Card Printer cannot be held liable for any errors that may be found in this manual, or for any loss or damage arising accidentally or as a result of dissemination or use of this manual.

Trademarks

Zenius, Evolis Premium Suite and Evolis High Trust are trademarks of Evolis Card Printer. All other trademarks belong to their respective holders.

Warranty

Refer to the warranty notice supplied with your printer for warranty terms and conditions and limitations.

Environmental information

Evolis is committed to helping the environment by reducing the energy consumption of its products.

Recycling of end-of-life products

The manufacture of the equipment that you have purchased required the extraction and use of natural resources. It may contain materials that are hazardous to health and the environment.

To prevent the dispersal of such materials into our environment and reduce the pressure on our natural resources, we recommend that you use existing collection systems. These systems will appropriately re-use or recycle most of the materials in your end-of-life equipment.



The crossed-out dustbin symbol on your device is a reminder to use these systems.

If you need further information on collection, re-use and recycling systems, contact your local or regional waste management body.

Do not hesitate to contact us to find out more by visiting our website at www.evolis.com or by emailing the following address: info@evolis.com.

About your new printer

Thank you for choosing an Evolis printer.

Using your new printer, you will be able to create a wide variety of high-quality cards and badges which can be printed in various thicknesses, colours and styles. This printer uses consumables and accessories available from Evolis. For further details, visit our website at www.evolis.com.

Warranty registration

Please register on line at www.evolis.com to receive our special offers and general information.

Once on the website, click on **Drivers and Support** then on **Register your printer** and fill in all the fields, giving in particular the model and serial number found on your printer.

Getting started

The purpose of this user guide is to guide you, step by step, through your printer and how it works. Take some time to read it in order to better understand your printer and its features, and to save time during installation and use.

As with all Evolis products, a great deal of care has been taken over this manual. Should you find an error, however, please let us know by emailing us at info@evolis.com.

Contents

The bookmarks found top left of your screen can be used to navigate between the various sections in this user guide.

Icons

The following icons are used in this manual to highlight important information:



Information providing further details or depth about certain points in the main text.



Indicates that failing to take the recommended action is liable to damage your printer.



This symbol indicates that a video showing the procedure is available on the www.evolis.com website and clicking on it takes you straight to on-line help.



This symbol links to Evolis Print Center, accessible from your computer, which you can use to administer and manage you printer and change its settings.

Zenius

Getting started

1-1 Unpacking

Your printer is supplied with several accessories that we ask you to look at closely. This list may vary depending on your location.

The printer is shipped in special packaging designed to prevent any damage in transit. If you notice any visible damage, do not hesitate to contact the shipper and immediately inform your Evolis dealer, who will tell you the procedure to follow.

Evolis takes great care over the quality of its packaging and we ask that you keep this packaging somewhere clean and dry.



You will be asked for the full original packaging (outer box, inner wedges and protective bags) in the event that the printer is returned. If the printer is returned without its original packaging and components are damaged in transit, these components will no longer be covered by the warranty. You will be charged for new packaging for shipping the printer back to you.

Accessories supplied with your printer:

- Power supply unit - SWITCHBOX Type F10723-A or CWT type KPL-065M.
- Mains power cable.
- USB cable.
- Installation, documentation and software CD-ROM.
- Starter cleaning kit.
- Quick installation guide.
- Warranty notice.



**If any of these components is missing, please contact your Evolis dealer.
Use only the power supply unit supplied with your Evolis printer.
SWITCHBOX Type F10723-A or CWT type KPL-065M.
Use only the USB cable supplied with your Evolis printer.**



The Evolis printer must be placed in a dry location, protected from dust and draughts but well-ventilated. Take care to keep your printer on a flat, sturdy surface able to bear its weight.

1-2 Description of the printer and its functions

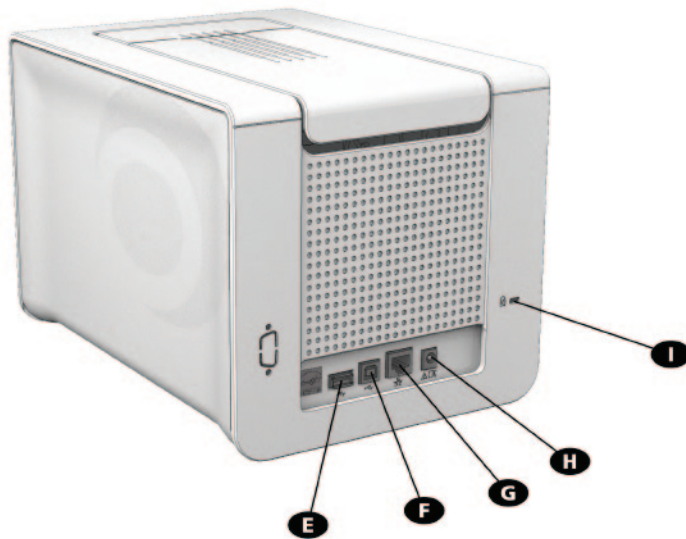
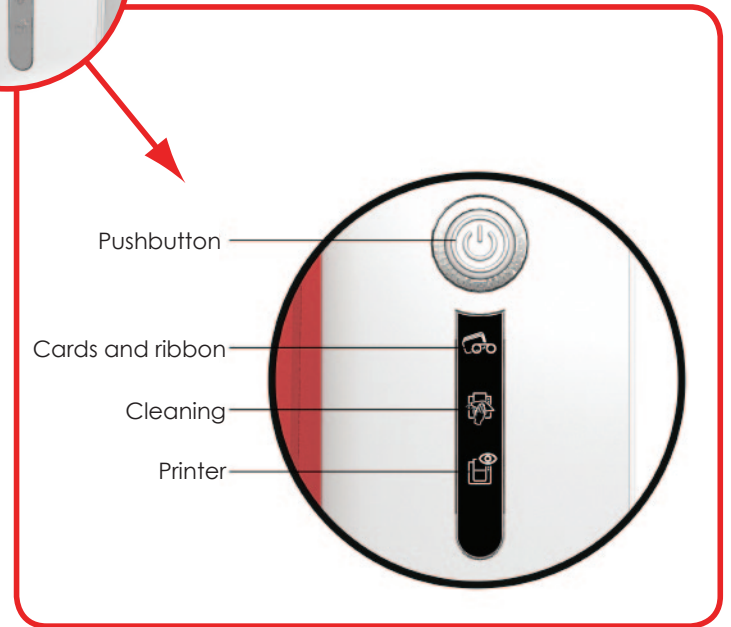
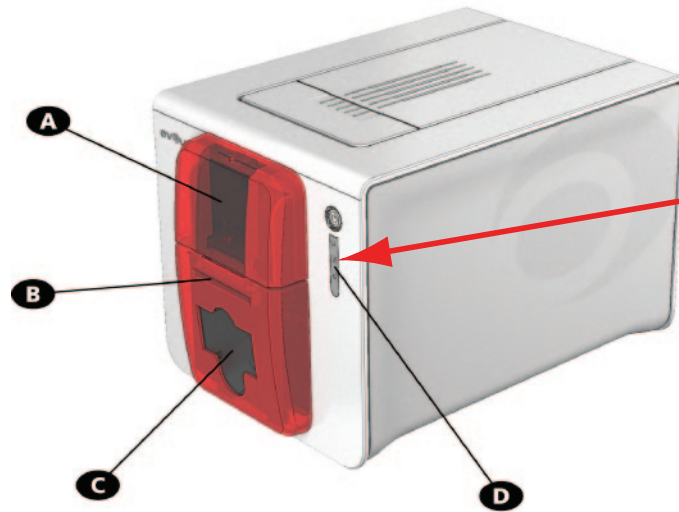

- A** - Card input feeder
- B** - Manual card feeder
- C** - Output hopper
- D** - Control panel

- E** - USB connectors (option)
- F** - USB connector (std)
- G** - Ethernet connector (option)
- H** - Power cable socket
- I** - Kensington lock



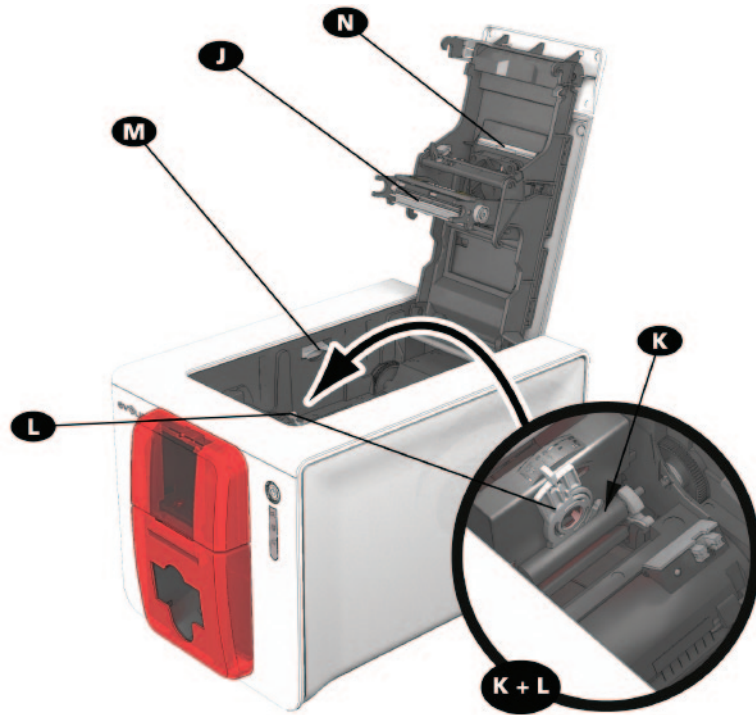

- J - Thermal print head
- K - Cleaning roller
- L - Card thickness adjustment gauge



- M - Side panel opening mechanism
- N - Dust filter
- O - Serial number label



Access to the side panels of the machine and the option module fitting/removal areas is restricted to your retailer/installer or to experienced users. The machine should always be disconnected from the power supply (unplugged) before carrying out any work on it.



Look at the getting started video described in the following section.

1-3 Installation

1-3a CONNECTING THE PRINTER

➤ Connection to the power supply



The printer must be connected to a properly protected and earthed electrical installation.

FI: Laite on liitettävä suojamaadoitus koskettimilla varustettuun pistorasiaan.

NO: Apparatet må tilkoples jordet stikkontakt.

SE: Apparaten skall anslutas till jordat uttag.

- ➊ Connect the power cable to the power supply unit, then plug the power supply unit connector into the printer.
- ➋ Next, plug the end of the power cable into an earthed power socket.
- ➌ The printer is powered on: the control panel lights up showing the printer is working properly. If the control panel does not light, then either installation has not been carried out correctly or the printer is not working properly. Check the installation.



Before attempting any maintenance, ensure that the power cable is always unplugged. For your personal safety, ensure that the cable and power supply unit remain easy to access, especially in the event of an emergency.



To save energy, the printer will automatically switch itself to standby mode after 10 minutes of inactivity. The printer switches to hibernation mode after 30 minutes in standby mode.

The standby times can be configured in the Evolis Print Center. In standard standby mode, sending a print request restarts the printer and quickly pressing (for 1 second) on the button exits the printer from hibernation mode.

➤ Connecting the USB cable



Under no circumstances should you connect the USB data cable before installation of the printer driver is complete.

Refer to the section on printer driver installation for further details, and follow the instructions carefully.

1-3b RIBBONS

Evolis original High Trust® ribbons optimise your printer's operation and avoid causing damage to it. The use of ribbons from other suppliers is liable to damage your printer and voids the manufacturer's warranty for the printer.

For optimum print quality, Evolis recommends that the printer is fully cleaned every time the ribbon is changed. See the Servicing and Maintenance section of this manual.

► Fitting the ribbon



The printer automatically recognises the ribbon inserted.

- 1 Open the cover.
- 2 Insert the ribbon as shown.
- 3 Close the cover and press until a click is heard.



1



2



3

Zenius

1-3c CARDS



*For optimum quality, the cards used must be ISO 7810 certified.
Use only the card types recommended by Evolis.
Do not touch the printable surface of the cards in order to preserve print quality.
Do not use cards that have been damaged, folded, embossed or dropped on the floor.
Keep your cards protected from dust.*

➤ Loading the cards

- 1 Open the card feeder.
- 2 Insert the cards, a maximum of 50 cards of thickness 0.76 mm. Ensure the cards are positioned as illustrated in the diagram.
- 3 Close the feeder.

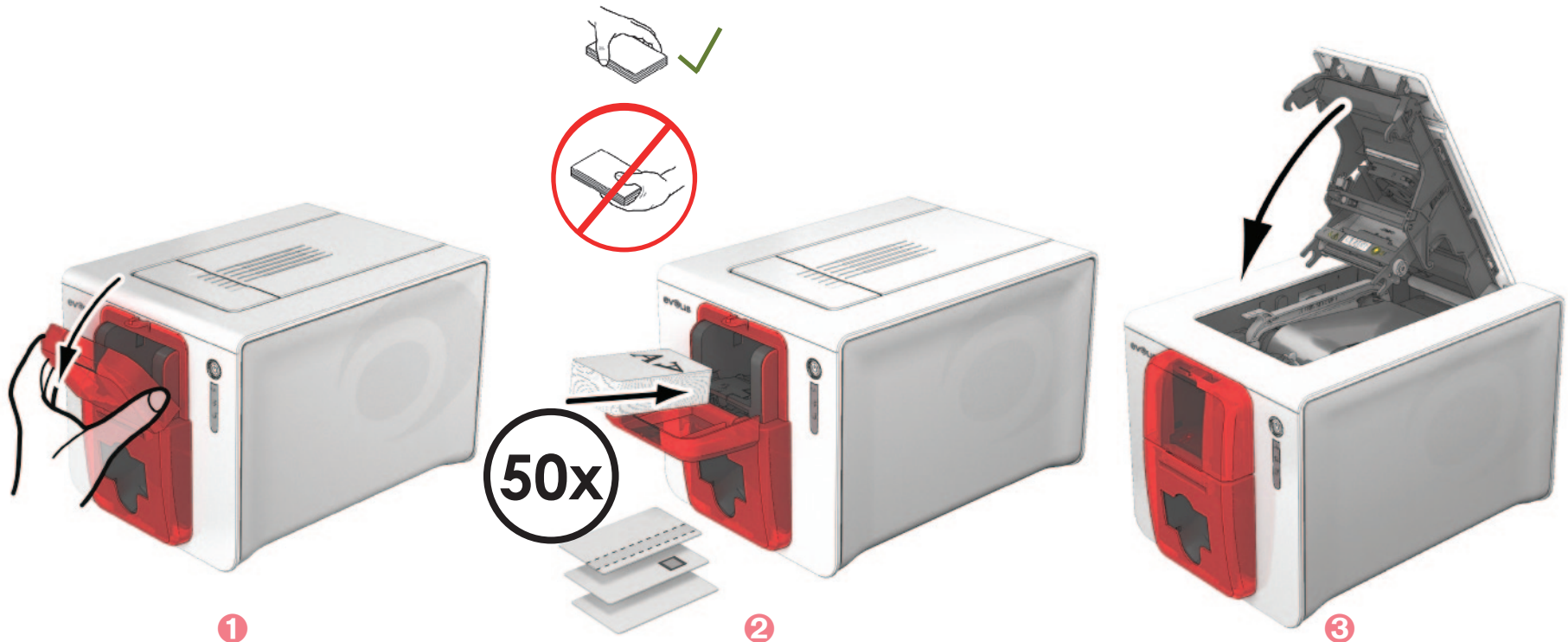

1

➤ Removing printed cards

Once the print cycle is complete, cards are delivered into the output hopper below the card feeder. This output hopper is designed to collect the printed and/or encoded cards. The printer is equipped with an output hopper with a maximum capacity of 20 x 0.76 mm cards.

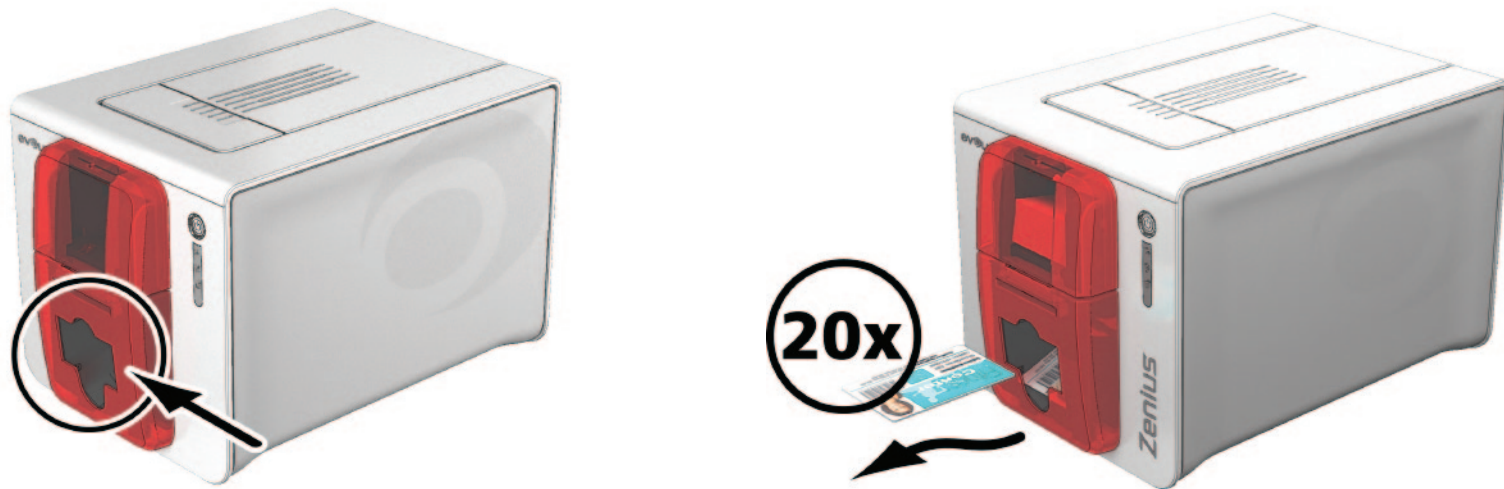

➤ Adjusting card thickness

The printer is equipped with a manual card thickness adjustment mechanism which can be reached through the inside of the printing unit when the cover is open. The printer accepts cards varying in thickness from 0.25 mm to 0.76 mm. The factory setting is 0.76 mm.

Zenius



1

To adjust card thickness:

- 1 Open the printer cover by pressing on the opening lever, then tilt the cover up.
- 2 Adjust the thickness of the cards used by moving the gauge from right to left to the desired card thickness.
- 3 Then close the cover.

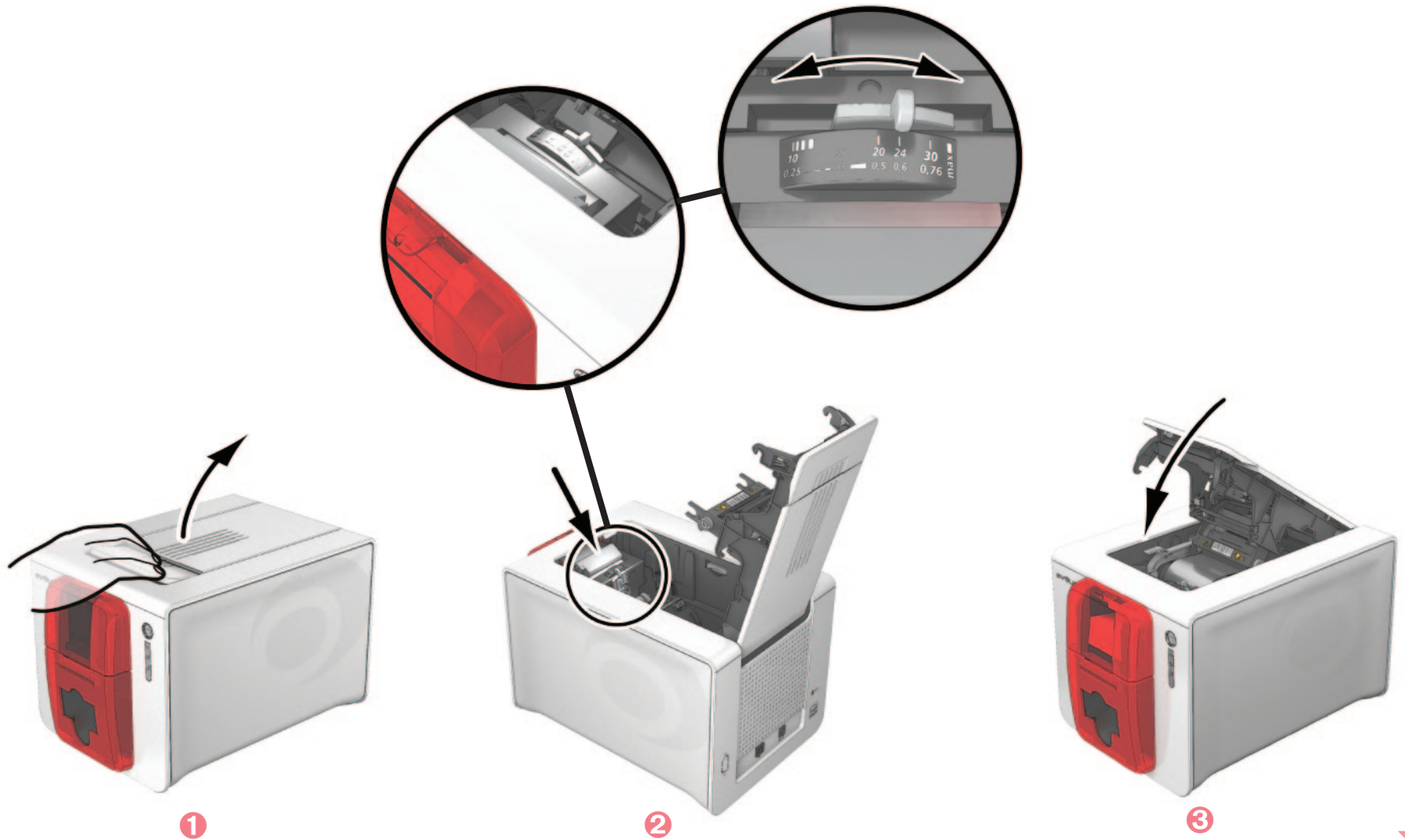

1

> Inserting cards manually

Cards may be inserted one by one into the manual feeder. Manual insertion must be configured beforehand in the Evolis Print Center (see section 2-2, Managing the print settings).

- 1 After starting your print task, insert a card into the manual feeder. The card will emerge automatically when printing is complete.



The printed card can be programmed in Evolis Print Center to be ejected either from the manual feeder or the output hopper.

Zenius

2

Printing

2-1 Installing the print driver

New advanced functions automate printer configuration after the print driver has been installed.

Your printer is delivered with a CD containing the print drivers for Windows and Macintosh platforms.

To install a print driver, insert the CD into your computer and select the print driver menu. A program will guide you through the entire installation process.



Do not connect your USB cable to your computer until prompted to do so by the installation program. For the connection procedure, see the section on Connecting the Printer.



Follow the installation procedure scrupulously. All versions of Windows and Macintosh require the user to have administrator rights to install the driver.

Zenius

2

2-2 Managing the print settings

Once the ribbon has been installed, your Evolis printer will automatically adapt its parameters and settings to suit the ribbon.

A graphic application called Evolis Print Center is available to help you if necessary to change certain predefined settings.

To access this application:

- From the **Start** button on the bottom left of your screen in the Windows task bar, select **All programs, Evolis Card Printer, Evolis Premium Suite, Evolis Print Center**
- The application displays all connected Evolis printers.

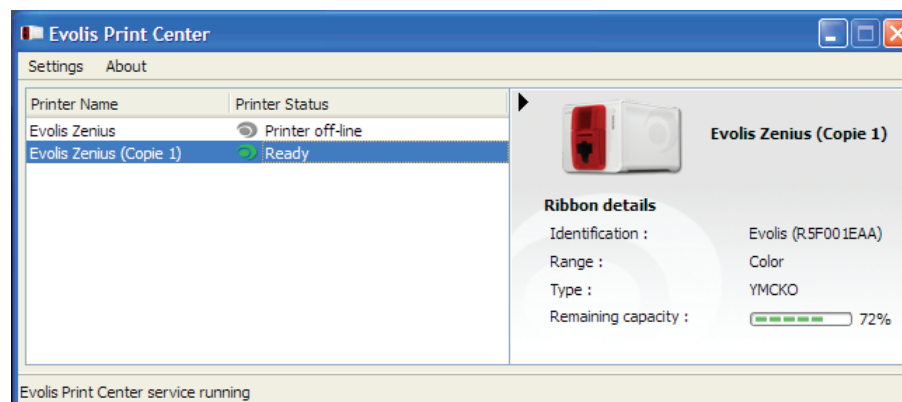

Zenius



2

- Select the desired printer.
- Right click the name of the printer, select **Properties** to access the settings or double (left) click the name of the printer.

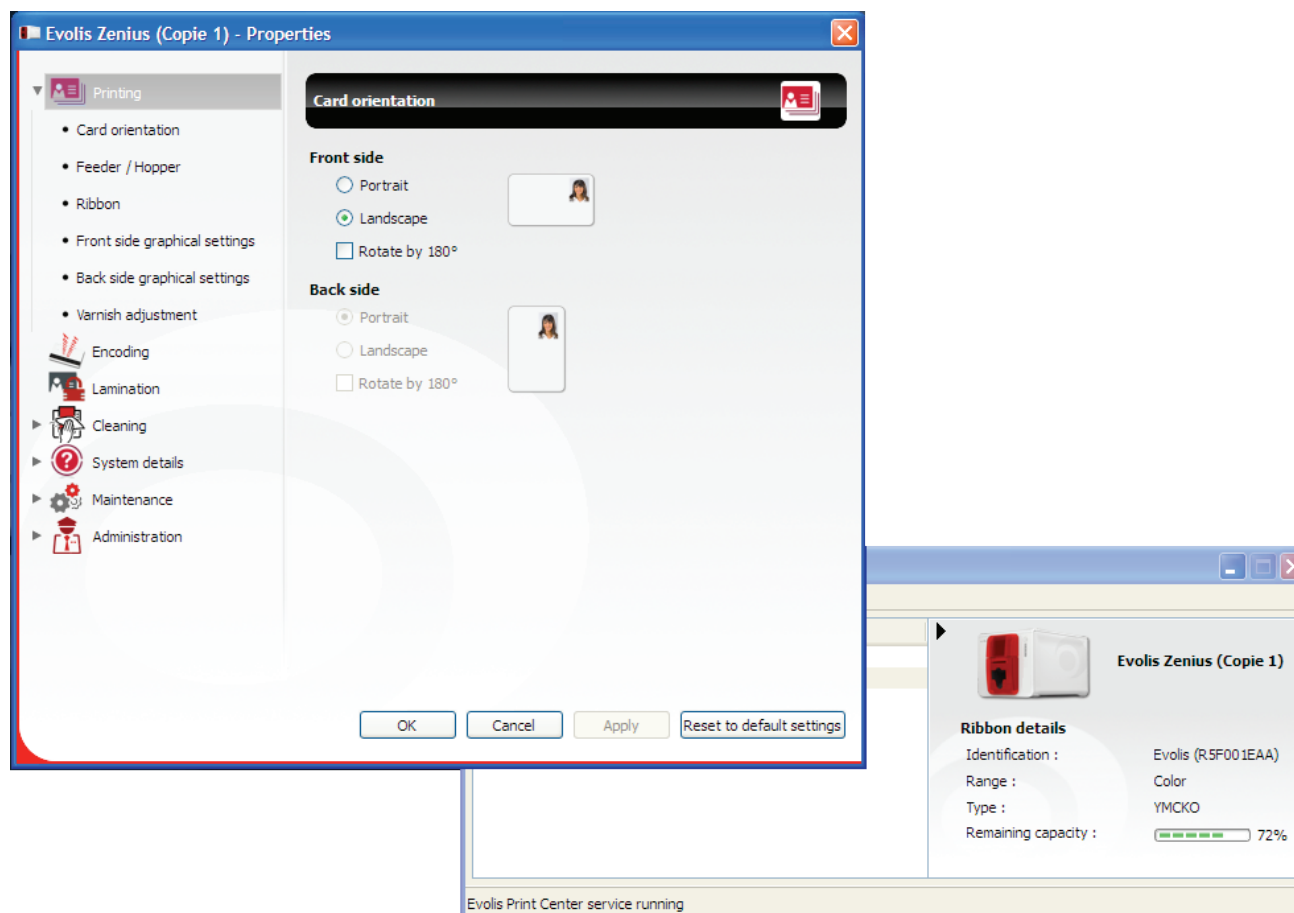

Pay attention to the settings defined under the print driver Properties and do not hesitate to contact your Evolis dealer for any advice and assistance needed before making any changes.



Please refer to the Evolis Print Center manual for more detail on the meanings of each of the settings.

2

2-3 Notification of messages and warnings

The Evolis Printer Manager has an additional function allowing the printer to communicate with the user with notifications.

There are several types of notifications:

- Messages about the maintenance of the printer.
- Messages and alerts associated with the ribbons, their compatibility with your printer or the nature of your print requests.
- Warnings about problems which have stopped the printer.

When the **Evolis Printer Manager** is active, a small icon is displayed in the bar on the bottom right of your screen.



The colour of the icon varies according to the status of the printer:

- **Green:** Printer ready
- **Orange:** Information message issued - printing stopped
- **Red:** Warning message issued - printing stopped
- **Grey:** Printer in hibernation mode, disconnected or communication interrupted.

When a notification is issued, it is displayed in a window of the following type:



Depending on the type of message, you can either:

- **?** Get additional help from the Evolis support site (requires an Internet connection).
- **X** Interrupt the printing task.
- **↺** Restart the task.

The **Evolis Printer Manager** service can be disabled by right-clicking the Evolis icon on the status bar.



Interrupting the Evolis Printer Manager service is only recommended if there is a conflict with other applications installed on your computer. The Evolis Printer Manager service is the best way of monitoring your printer effectively from your workstation.

2

2-4 Printing a card

A large number of Windows applications allow documents to be printed (for example the tools in Microsoft's Office suite, i.e. MS-Word, MS-Access, Ms-Excel, MS-PowerPoint).

To gain familiarity with the layout of a card and configuring its formatting and printing, we suggest the following example.

> In Microsoft® Word

After having set the Evolis printer as the default:

- Start the MS-Word application
- Click on the **File** in the menu bar, then on **Page Setup**
- In the **Margins** tab, set all margins to '0', then in the **Orientation** section, select **Landscape**.
- The Paper tab has a **Paper Size** option, select **CR80 Card**
- For Word 2010: click the **Page layout** tab, then click on **Size** and select 'CR80 Card'
- Close the window by clicking **OK**.

Your Word window should now look like this:

You are ready to customise your card by adding the various items that go to make up a card:

- Logo and Illustration
- Identification photo
- Fixed and variable texts
- Bar Code, etc.

Once ready, click on **File** and then on **Print**.

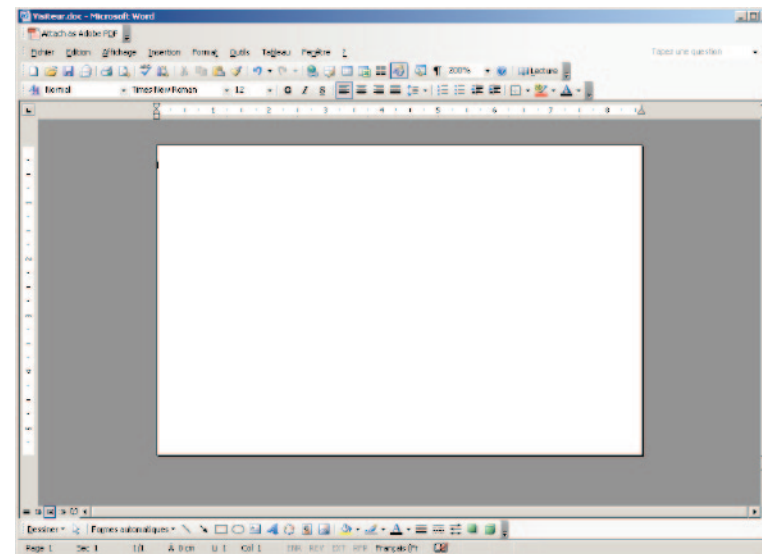

Zenius

2

2-5 Connecting to a network (Ethernet)

All Evolis printers can be fitted with a TCP/IP network connection. This function is available as standard on the Zenius Expert.

Out of the box, the printer comes configured in DHCP mode (Dynamic Host Configuration Protocol), which means that its IP address is supplied by the network. In addition to these basic settings, the network administrator has the option of configuring the printer differently in order to comply with the constraints imposed by the corporate LAN:

- Printer connected in a subnet, in DHCP mode
- Printer connected to a subnet in fixed IP address mode, with WINS resolution
- Printer connected to a subnet in fixed IP address mode, without WINS resolution

The printer may be identified on the network in two ways:

- By its Hostname (NETBIOS)
- By its IP address.

In addition, the Ethernet connection wizard will automatically detect all installed Evolis printers.

The user-definable settings are:

- IP address of the printer
- Subnetwork mask
- Gateway
- WINS server



Changing the printer's basic settings, without prior knowledge of the layout of the LAN in question or without genuine technical knowledge may result in a malfunction of the printer, and may even extend to a more widespread failure of all or part of the LAN. Contact your System and Network Administrator before connecting to or changing the settings for your local area network.



For further details, refer to the 'Network administrator manual, Configuring an Evolis printer via Wi-Fi or Ethernet' manual.

Zenius

3

Maintenance

3-1 General warranty information

Your Evolis printer has been designed to give you long service and needs only minimal regular maintenance. Please comply with the instructions given below to ensure that it runs satisfactorily.

Keep your warranty cover!



The manufacturer's warranty is subject to strict adherence to the routine servicing and maintenance instructions, and in particular the printer cleaning cycles.

Any failure to follow the maintenance and servicing procedures described in this section voids the print head warranty.

Evolis declines any liability where there has been a failure to carry out required maintenance on the printer.

The print head is a wearing part and an extremely sensitive printer component. Its useful life can be seriously curtailed by the presence of dust, liquids or solids in the printer's immediate environment, on the print head or on the cards. Users must take all necessary precautions to insert only clean cards, free of dust deposits or foreign bodies, into the machine.

The frequency and quality of cleaning are decisive factors enabling users to extend the print head's useful life and to ensure excellent print quality. Particular care must therefore be taken with cleaning. Users must comply with the servicing and maintenance instructions as fully described in this section.

In addition, the use of Evolis brand ribbons ('Evolis High Trust®') also ensures that your equipment operates properly. Use of ribbons not approved by Evolis may as a consequence affect the quality and reliability of print jobs, produce low quality printed output and even affect the printer's operation. The manufacturer's warranty does not cover physical damage or quality problems caused by using non-Evolis approved ribbons.

Evolis provides replacement parts and consumables that you can refer to within this user guide or by visiting the website at www.evolis.com.

Zenius

3

3-2 Routine printer cleaning

3-2a ROUTINE PRINTER CLEANING



*The print head warranty is directly linked to routine cleaning of your printer.
If you do not carry out this cleaning at the required times, the print head warranty will cease to be valid.*



*Recommended cleaning cycle: whenever the ribbon is changed
Mandatory cleaning cycle: when the cleaning warning is triggered
Servicing accessory: adhesive cleaning card.*



*Your printer is fitted with a cleaning warning system which is triggered after a certain number of cards have been inserted.
You should proceed with the routine cleaning of your printer as soon as the warning is triggered.
If you continue to run the printer despite the warning and if the warning light remains lit, the print head warranty will be automatically voided owing to a failure to comply with your contractual maintenance obligations.*

Printer	Cleaning required after: <i>(warning light flashing)</i>	Number of cards remaining before warranty voided <i>(warning light steady)</i>	Warranty invalid after: <i>(warning light steady)</i>
Zenius	1000 cards	200 cards	1200 cards
Primacy	1000 cards	200 cards	1200 cards
Elypso	1000 cards	200 cards	1200 cards

Zenius



3

Follow the procedure below to ensure you have carried out regular cleaning properly:

Repeatedly running the adhesive card through the printer cleans the cleaning roller in order to maintain print quality and increases the service life of the print head.



- 1 Remove the cover from the printer as shown.
- 2 Using the lever, set the card thickness to the MAX position.
- 3 Remove the ribbon as shown on the diagram.
- 4 Close the cover and check it has clicked shut.

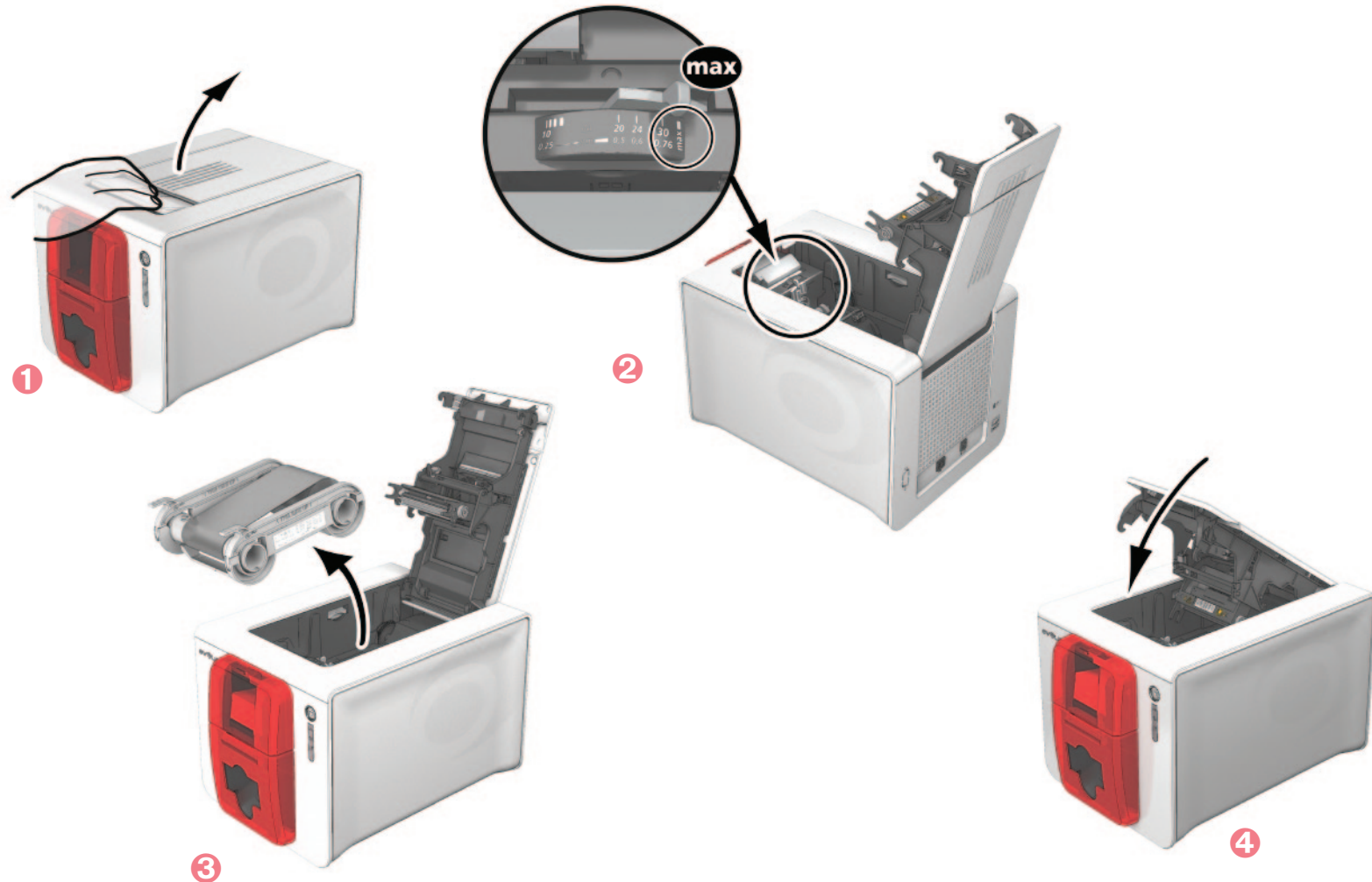

Zenius



3

- 5 Open the feeder.
- 6 Remove any cards present in the feeder.
- 7 Close the feeder.
- 8 Double click the cleaning button on the control panel before inserting the cleaning card.
- 9 Remove the film from the adhesive card 1 and insert the cleaning card into the manual feeder as shown, adhesive side up 2. Cleaning starts.
- 10 The used cleaning card is ejected automatically by the manual feeder.

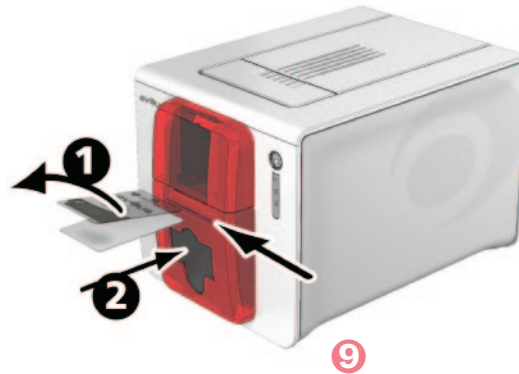
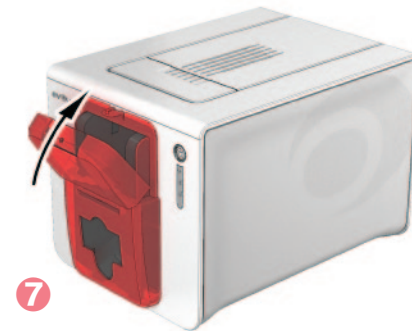
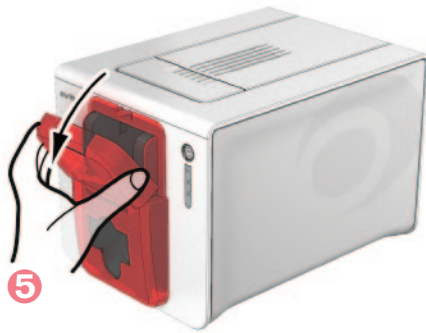

Routine cleaning may also be carried out from the Evolis Print Center by clicking on "Start cleaning".



Before using your printer, remember to reset the gauge to the desired card thickness.

Zenius

3

3-2b SERVICING THE PRINT HEAD



**Recommended cleaning cycle: whenever the ribbon is changed.
Servicing accessory: special cotton bud impregnated with isopropyl alcohol.**

However, to maintain the original print quality and to absorb surplus ink on the print head, we recommend that you regularly clean the print head (whenever the ribbon is changed and during the routine cleaning) using the cotton buds supplied by Evolis. You must also protect the print head and its components from any discharge of static electricity.



***Unplug the printer from its power supply before cleaning the print head.
Follow the cleaning cycles scrupulously.
Avoid any contact between the print head and any metal or sharp objects.
Avoid touching the print head directly with your fingers, as this could affect print quality or permanently damage the print head.***

Zenius



3

Follow the procedure below:



- 1 Take an Evolis cotton bud and press the middle of the tube until the end of the cotton bud is impregnated with alcohol.
- 2 Unplug the power supply cable, open the cover then find the print head.
- 3 Gently rub the cotton bud from left to right along the print head for a few seconds.
- 4 Close the cover. Reconnect the printer.

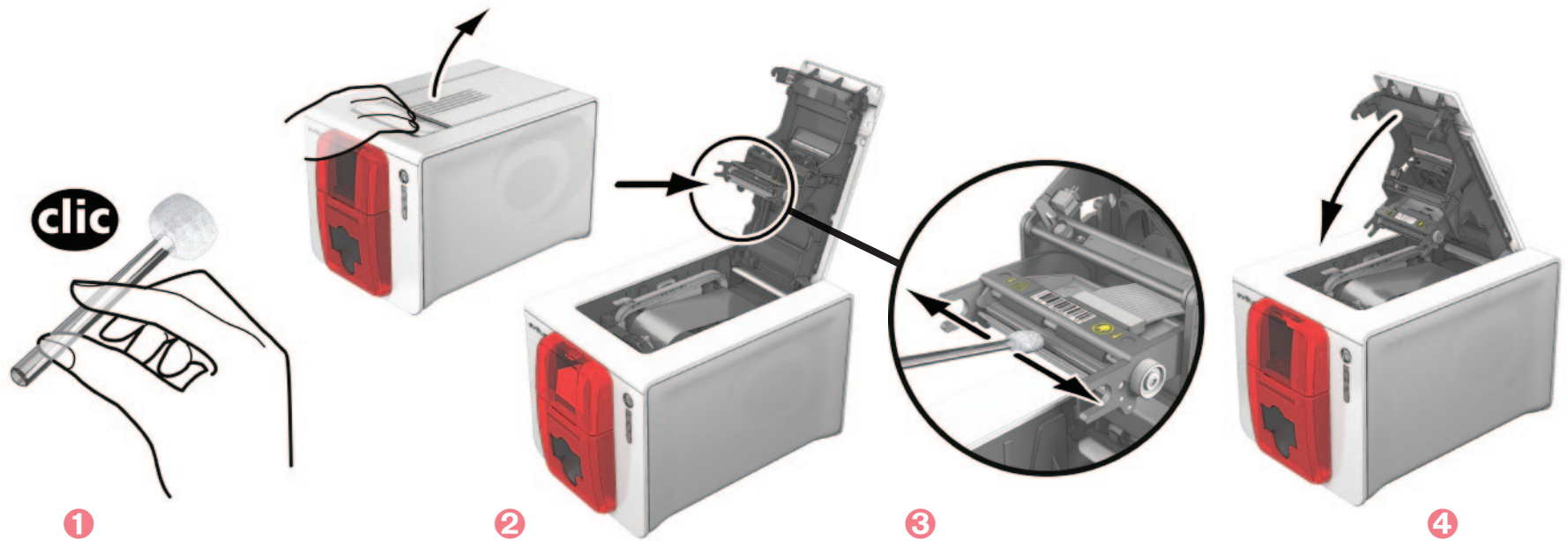

Wait for 2 minutes after cleaning before using your printer.

Zenius

3

3-3 Advanced cleaning

For a more in-depth clean, we recommend carrying out an advanced clean every five routine cleaning cycles.

Evolis provides an Evolis High Trust® maintenance kit consisting of 2 adhesive cards, 2 impregnated "T" shaped cards, a cleaning pen and a box of 60 wipes. The "T" shaped card is used to clean the card feed rollers and the magnetic encoder head. To ensure advanced cleaning is carried out properly, the procedure given below must be followed.

3-3a PRINTER CLEANING



Recommended cleaning cycle: every 5 routine cleaning cycles.
Servicing accessory: impregnated "T" shaped card and adhesive card

Follow the procedure below:



- 1 Open the printer cover.
- 2 Sing the lever, set the card thickness to the MAX position.
- 3 Remove the ribbon as shown on the diagram.
- 4 Close the cover and check it has clicked shut.

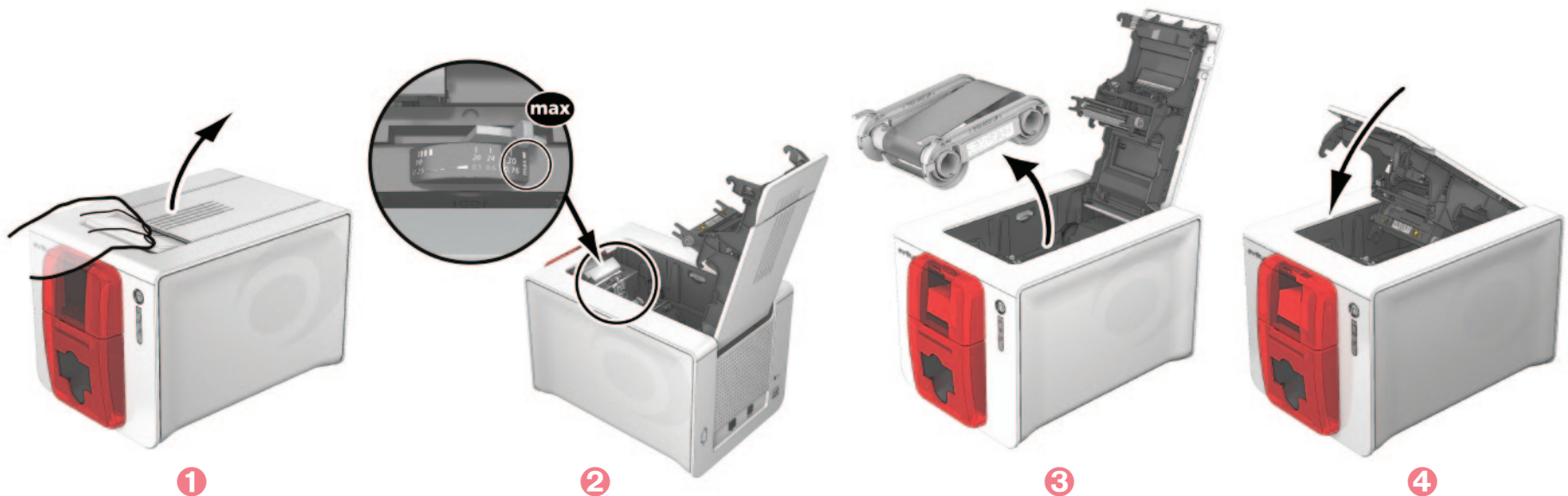

Zenius



3

- 5 Remove any cards present in the feeder.
- 6 Double click the cleaning button on the control panel before inserting the cleaning card.
- 7 Take the "T" shaped cleaning card and insert it in the feeder as shown. Cleaning starts.
- 8 Remove the "T" shaped card, then remove the film from the adhesive cleaning card ① and insert the cleaning card into the manual feeder as shown, adhesive side up ②. Cleaning starts.
- 9 The used cleaning card is ejected automatically by the manual feeder.

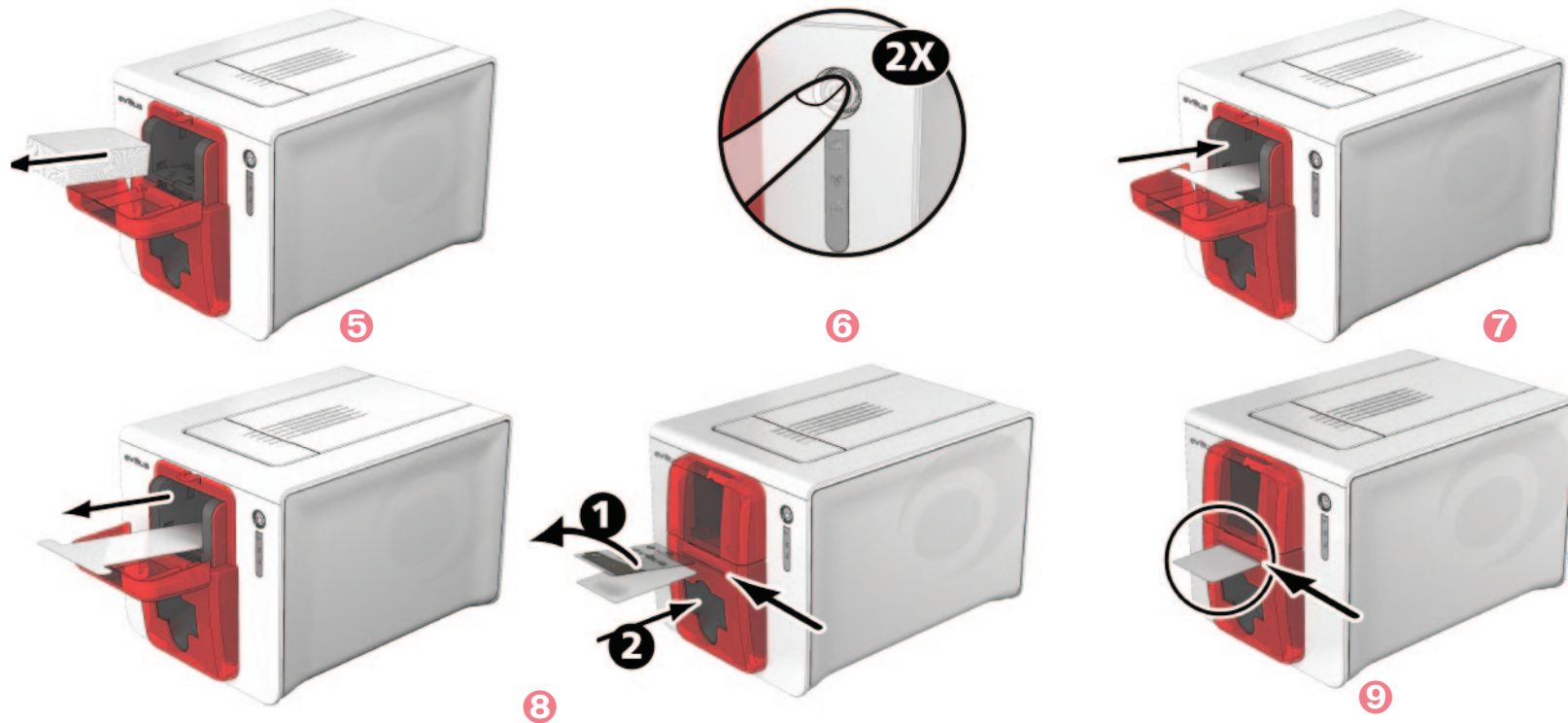

Routine cleaning may also be carried out from the Evolis Print Center by clicking on "Start cleaning".



Warning, the "T" shaped card must be used just after the sachet is opened.



Before using your printer, remember to reset the gauge to the desired card thickness.

Zenius

3

3-3b SERVICING THE PRINT HEAD



**Recommended cleaning cycle: every 5 routine cleaning cycles.
Servicing accessory: cleaning pen**



**Unplug the printer from its power supply before cleaning the print head.
Follow the cleaning cycles scrupulously.
Avoid any contact between the print head and any metal or sharp objects.
Avoid touching the print head directly with your fingers, as this could affect print quality or permanently damage the print head.**

The cleaning pen can be used up to 8 times for cleaning the print head.

Follow the procedure below:



- 1 Remove the cover from the cleaning pen.
- 2 Unplug the power supply cable, open the cover then find the print head.
- 3 Gently rub the pen from left to right along the print head for a few seconds.
- 4 Close the cover. Reconnect the printer.

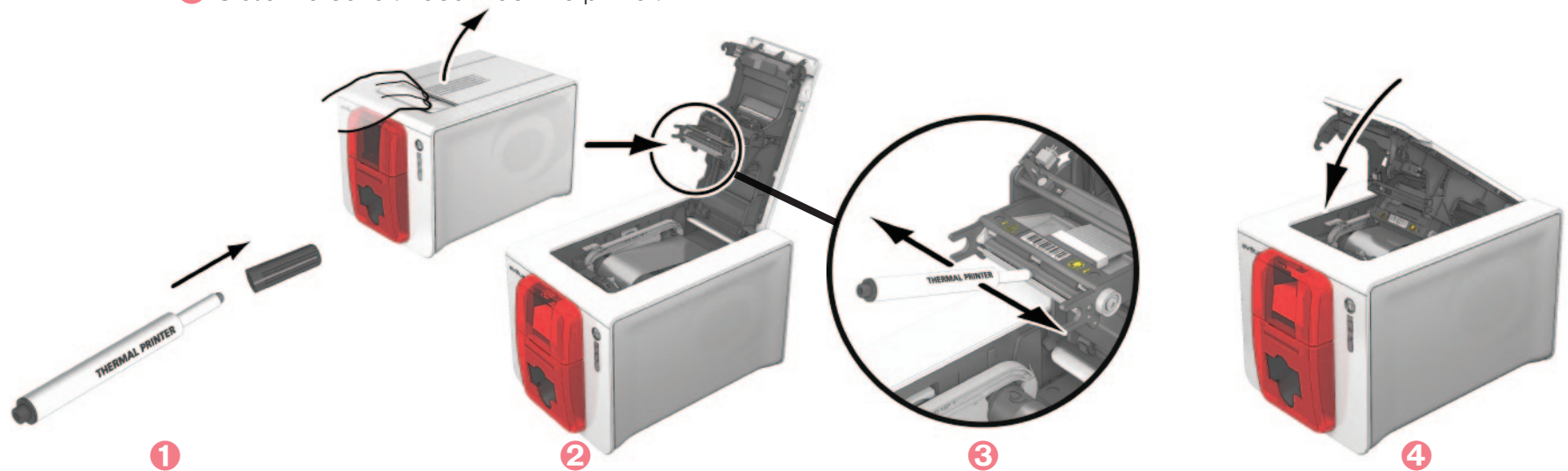

Wait for 2 minutes after cleaning before using your printer.

3

3-3c SERVICING THE DUST FILTER

The dust filter is located above the print head fan. This filter can become fouled up over time and it is recommended to clean it once a year or every 10,000 cards depending on your working environment.



- 1 Open the printer cover. Locate the dust filter.
- 2 Remove the filter by pulling it upwards and slide it out to release it completely.
- 3 Once the filter is removed from its slot, obtain a cleaning wipe supplied by Evolis.
- 4 Clean the filter by rubbing the wipe either side of it.
- 5 To replace it, insert it in its slot (notch towards you) and lower it until you hear it click indicating it is correctly positioned.
- 6 Close the cover.

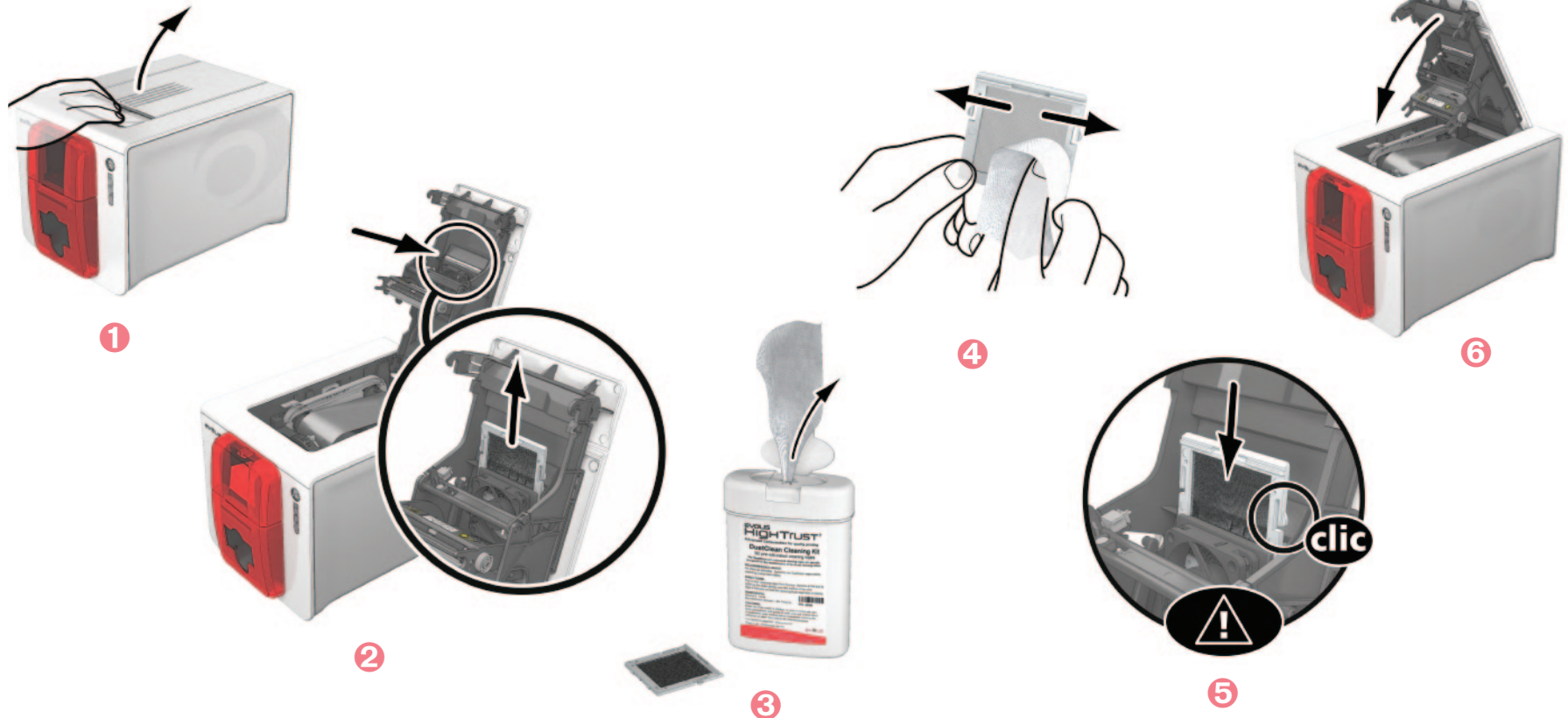

Zenius

4

Help

This section gives a number of suggestions allowing problems that may arise when using your printer to be pinpointed. If you do not manage to solve your problem, this section also explains how to contact Evolis technical support.

4-1 Warnings and diagnosis

Although the Evolis printer was designed to work independently, keeping user involvement to a minimum, it may nonetheless prove useful to gain some familiarity with the main warnings.

See **section 1 - Description of the printer and its functions** for further details about the control panel.

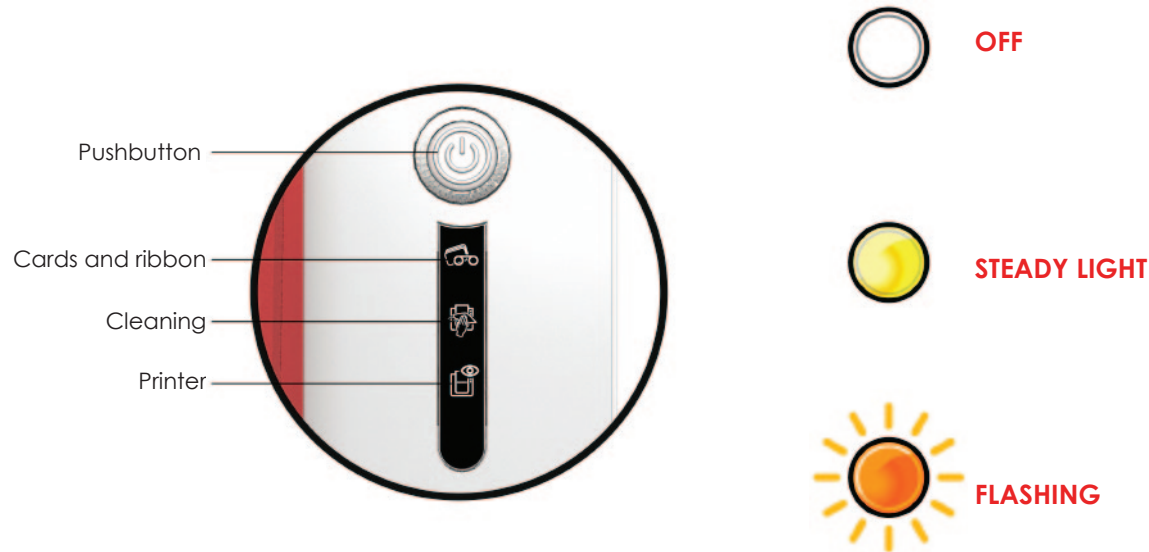



PRINTER READY

- The printer is ready to receive data.



PROCESSING

- The printer is receiving data.



RIBBON

- No ribbon in the printer.
- End of ribbon.
- The ribbon is not correctly fitted.
- The ribbon is torn.
- The ribbon is not recognized.

Check the condition of the ribbon in the printer. If you have a print job in progress, this restarts with a new card.



CARDS

- No cards in the card feeder.

Put cards back into the feeder - the process starts again.

- Card loading error.

Check cards have been loaded. For any other problem contact your Evolis dealer.





PRINTER COVER OPEN

- The printer cover is open.
Close the cover again. The printer starts up.

MECHANICAL ERROR

- Card jammed in the printer.
- Mechanical component fault.

Open the cover and hold down the pushbutton in order to eject the jammed card. For more details, refer to section 4-3b. If the problem persists, contact your Evolis dealer for assistance.



ROUTINE CLEANING (after 1,000 cards have been inserted)

- The printer must be cleaned.
See section 3 - Maintenance

ADVANCED CLEANING

- The printer requires advanced cleaning.
See section 3 - Maintenance

Zenius





CLEANING
(after 1,200 cards have been inserted)

- The printer must be cleaned to avoid the risk of the warranty being voided.

See section 3 - Maintenance



WAITING FOR A CARD TO BE INSERTED OR REMOVED

- The printer is waiting for a card to be inserted or removed.

Insert a card or remove the card from the manual feeder (see section 1 - Getting started)

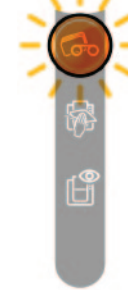

COOLING MODE

- The cooling system has been activated.

The printer pauses for a few seconds and restarts once it has returned to its normal operating temperature.



FIRMWARE UPDATE

- The printer is updating its Firmware.

The printer restarts following the update.



4

4-2 Diagnosis help

In this section, you will find all the information you need to carry out a few simple checks that you may be asked to run by your Evolis dealer to help you as effectively as possible.

4-2a PRINTING A TECHNICAL TEST CARD

We recommend that you print a technical test card to ensure that your printer is working properly. This card shows various items of technical information concerning the machine (serial number, firmware, cleaning operations, print head, etc.). You may be asked for these by your dealer.

► Printing a technical test card

- 1 Wait for any current print jobs to finish.
- 2 Check that there is a ribbon and card in the printer.
- 3 Press the pushbutton for four seconds. All the warning lights go out.
- 4 Press and hold down the pushbutton again.
- 5 The pushbutton light comes on.
- 6 Release the pushbutton once the light flashes.
- 7 The test card is printed in colour if a colour ribbon is fitted in the printer, or monochrome if the ribbon is monochrome.
- 8 The printed card is ejected into the output hopper.



Printing the technical test card can also be launched from the Evolis Print Center.

4-2b PRINTING A GRAPHIC TEST CARD

The graphic test card is used to check the print quality in colour or monochrome, the offsets and whether the ribbon is synchronised correctly.

To print the graphic test card, check first of all that a ribbon and a card are present in the printer.

Go to **Evolis Print Center**, select **System information** and click on the **Test cards** tab. Then click the **Graphic test card** button. The card is printed and the printed card is ejected into the output hopper.



Printing the graphic test card can only be launched from the Evolis Print Center.

Zenius

4

4-2c IDENTIFYING INSTALLED SOFTWARE VERSIONS

You can identify directly the system versions installed (print driver, set, etc.).

- 1 In Evolis Print Center, double click the name of the printer to display its **Properties**.
- 2 Click **System information**, then **System information**.



4

4-3 Troubleshooting



Do not attempt to use tools or other items to repair your printer in the event of problems, in case major damage is caused.

4-3a PRINTING PROBLEMS

> Nothing prints

1 Check the print driver

Check that there is a print driver for your printer in the Windows configuration.
Check that the printer is selected as the default printer.

2 Check the printer's power supply

Check that the power cable is correctly connected to the printer and to a working electrical socket.
Check that the printer is on and that the pushbutton is lit.
Make sure you are using the power supply unit supplied with the printer.

3 Check the USB cable

Check that the USB cable is connecting the printer to your computer.

4 Check the ribbon

Check that the ribbon is fitted correctly and that the cover is closed.

5 Check the cards

Check that there are cards in the card feeder.
Check that no cards are jammed in the printer.

6 Print a test card

See elsewhere in this section for the procedure to be followed.

> Blank card ejected

1 Check the ribbon

Check that the ribbon is not finished or damaged. Replace it or re-install it if necessary.

2 The print head may be damaged

Print a test card.

If the test card does not print, contact an Evolis dealer for technical support or visit the website at www.evolis.com.

Zenius



> Poor print quality

Small blemishes on the card

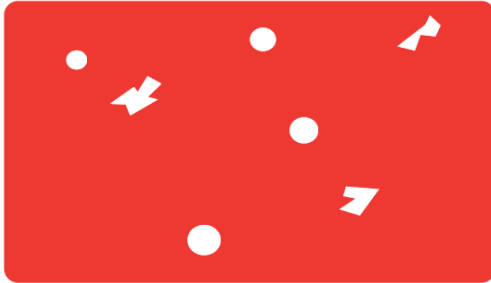

- **The card surface may be dirty.**
Check that your cards are perfectly clean.
Use new cards.
- **Cleaning roller or print head clogged.**
Run a cleaning cycle.

Horizontal white lines



- **The ribbon is not correctly fitted.**
Check that there are no wrinkles on the ribbon surface.
- **Print head dirty or damaged.**
Clean or replace the print head.

Blurred image

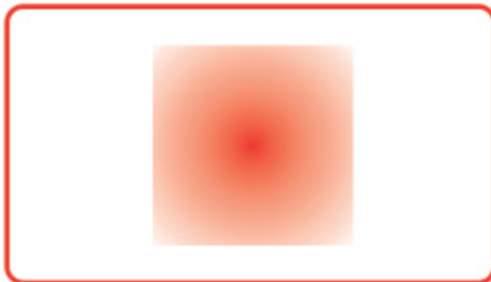

- **The ribbon is not correctly fitted.**
Check that the ribbon is correctly positioned in the printer.
- **Poor ribbon synchronisation.**
Open and close the printer cover to synchronise the ribbon.
- **Dirty printer or cleaning roller.**
Clean the printer
- **Use of incompatible cards.**
Check that the cards used match the specifications.



**We recommend that you obtain your cards from an Evolis dealer.
Use of cards obtained elsewhere is liable to adversely affect print quality and/or damage the print head.**

4

> Partial or incorrect printing

1 Check the print settings

Check that no area of the card design to be printed is outside the print margins.
Check the document orientation (portrait or landscape) in the Evolis Print Center configuration.

2 Check the interface cable

If irregular characters are printed, check that you are in fact using the USB cable supplied with your printer.
Check the connection between the computer and the printer.
Try using another cable of the same type.

3 Check that the printer is clean

Clean the printer, especially the cleaning roller.
See the maintenance section.

4 Check that the cards are clean

Store your cards protected from dust.

5 Check the ribbon

Check that the ribbon is fitted correctly.
Check that the ribbon spools freely.

6 Check the print head

Should horizontal straight lines appear on printed cards, it is likely that the print head is dirty or damaged.
See the section on maintenance and troubleshooting. If the problem persists, contact an Evolis dealer or visit the website at www.evolis.com.

Zenius

4

4-3b FREEING JAMMED CARDS

Control panel displays:



MECHANICAL ERROR

- Card jammed in the printer. Print jobs are interrupted.



Do not turn off your printer as this cancels pending print jobs in the printer's memory.

Remove the card as follows:

- 1 Open the printer cover and remove the ribbon.
- 2 Press the pushbutton to turn the card transport rollers. If the card is still stuck inside the printer, slide it manually towards the printer output. If there is more than one card, always push the top one first.
- 3 Replace the ribbon, then close the printer cover.

To prevent card jams:

- 1 Check that the card thickness gauge is correctly adjusted.
- 2 Check that the thickness of the cards used matches the specifications set out in Appendix A "Technical specifications" in this manual.
- 3 Check that the cards are flat. Keep them in a horizontal position.
- 4 Check that the cards are not stuck together. Shuffle the cards before loading them.

Zenius

4

4-3c REPLACING THE PRINT HEAD

The print head is a sensitive component of your equipment. It determines the print quality, and regular servicing along with an immediate environment free from dust or other particles ensure a lengthy useful life. Nonetheless, the print head may sometimes need to be replaced. Evolis has designed a unique device enabling users to undertake such replacement with no tools needed, simply by following the instructions very carefully.

Before doing anything else, please contact your Evolis dealer in order to check the advisability of replacing the print head. The dealer will supply a new print head if need be.



For more information on print head warranties, refer to the Evolis warranty booklet.

Zenius



4

To exchange the print head, please proceed as follows:



Before changing the print head, please unplug the power cable.

> Step 1 - Removing the defective print head

- 1 Open the printer cover.
- 2 Locate the print head.
- 3 Press on the plastic part behind the head (pressure plate) and pull on the head with the other hand as shown in the diagram in order to free the lugs from the holding fork, then remove the lugs from their slots.
- 4 Tilt the head carefully downwards and disconnect the connector linked to the cable without using force on the mechanism.

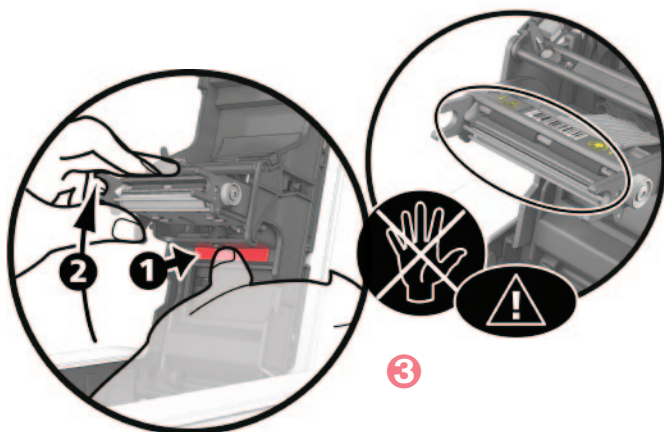
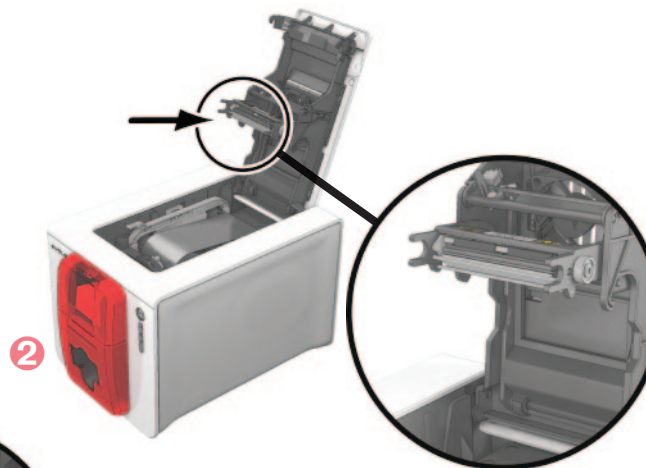

Zenius



4

> Step 2 - Installing the new print head

- 1 Note the code shown on the white label stuck on the print head. You will be asked for this code in Step 3.
- 2 Take the new head and insert it vertically (white connector upwards) raising it in the two guides so as to trap the lugs of the fork in their slots ❶. Then lower it by pressing on the two forks ❷, a click will be heard.
- 3 Connect the cable into its socket, making sure it is the right way round. Do not use any force, as this part is relatively fragile. Press down on each side of the connector to ensure a good connection is made.
- 4 The head is back in position.
- 5 Close the cover. The print head is now fitted.

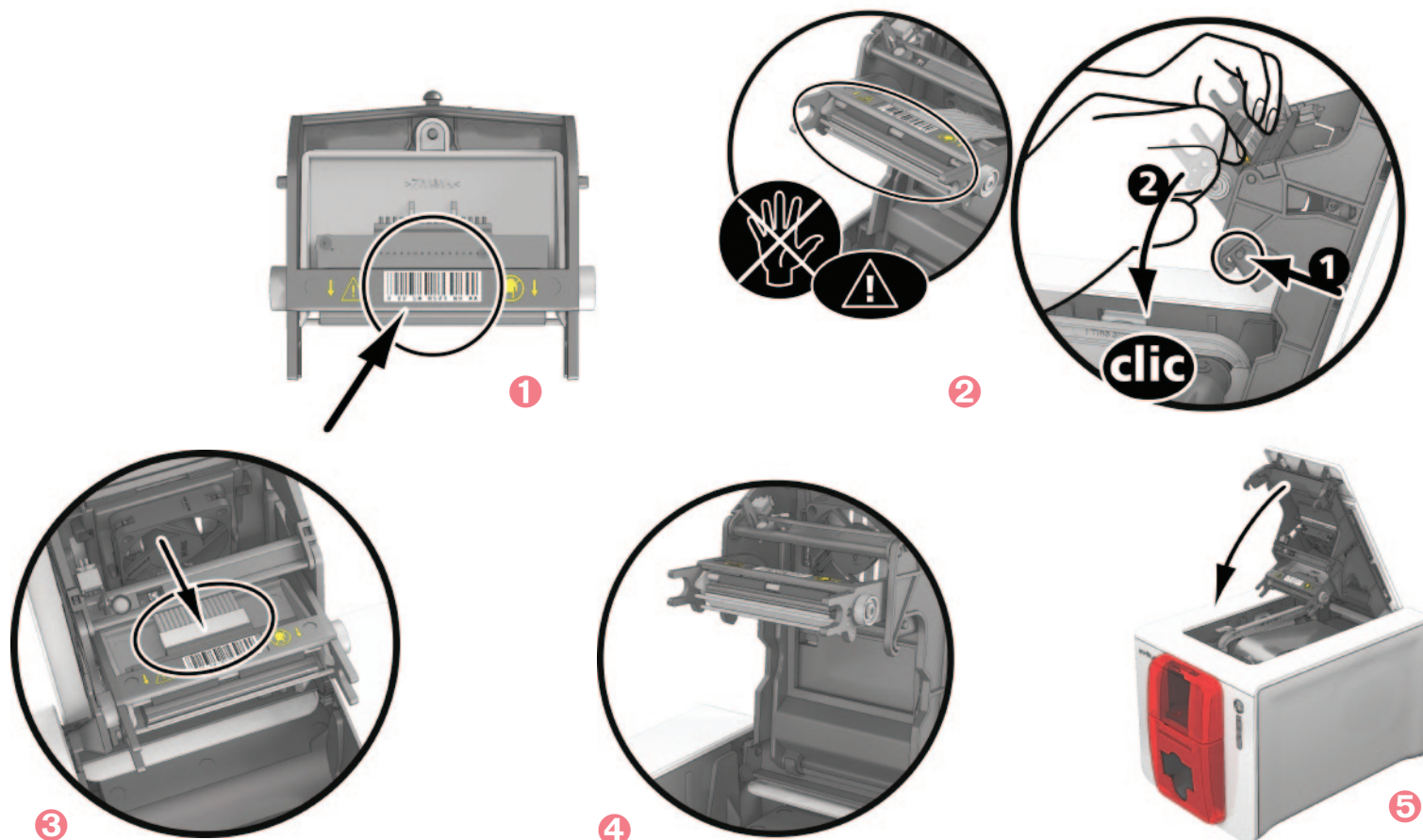

4

> Step 3 - Configuring the new print head

- 1 Power up the printer and check that it is properly connected to a computer on which the printer's Evolis Print Center is installed.
- 2 In **Maintenance** of Evolis Print Center, click on the **Change print head** tab.
- 3 Enter the PKN number of the print head kit in **Enter PKN no.**, the number you noted down in step 2. Then click **Confirm**.



If the print head kit number is not entered correctly, printer malfunctions may occur and the warranty may be voided.

> Step 4 - Cleaning the printer

On your printer's control panel, the "**CLEANING**" light is lit:



CLEANING



*Cleaning is absolutely necessary after changing the print head. No print jobs can be run until the cleaning operation has finished.
Refer to section 3 – Maintenance to carry out cleaning.*

Once cleaning has been carried out, your printer is once again ready to customise your cards.



Wait for 2 minutes after cleaning before using your printer.

Zenius

4

4-3d UPDATING THE FIRMWARE (under Windows)

Updating the firmware is a simple operation but one which, if not properly completed, can result in your printer breaking down. Before any update, please contact your Evolis dealer who will be able to guide you on the advisability or otherwise of carrying out an upgrade. In general, such updates are only required in the event of problem or malfunction that has been clearly identified by your Evolis dealer.

Updates can be downloaded from the website at www.evolis.com:

- 1 Go to the **Support & Drivers menu**, then select your printer model and click on the **Print drivers and Firmware link**.
- 2 Then click on the file for the corresponding Firmware.
- 3 Accept the download then save the file in a directory on your hard drive. The firmware is stored compressed as a zip file, which you will need to extract.
- 4 Then double-click on the file in the directory in order to run the firmware installation program.
- 5 When requested by the program, follow the instructions in order to select the printer and start the operation. The firmware download is in progress.
- 6 After about thirty seconds, the firmware has transferred to the printer and the operation is complete.
- 7 If the printer is not showing a 'READY' status, this means that the update has not been carried out correctly or, possibly, that the printer is not working properly. Check the connection cables and run a new update.

The update is complete, and your equipment is ready to customise your cards.



Never interrupt the transfer between computer and printer during the download phase (powering off the printer or computer, unplugging a cable). This would result in a complete inability to restart the printer. Should such an incident occur, please contact your Evolis dealer, who will replace your printer's processing board.



The update of the firmware can be carried out from the Evolis Print Center.

Zenius

4

4-3e UPDATING THE PRINT DRIVER

Updating the print driver is a task that is required in order to fix malfunctions or gain the benefit of new options.



Before any update, please contact your Evolis dealer who will be able to guide you on the advisability or otherwise of carrying out an upgrade.

Updates can be downloaded from the website at www.evolis.com:

- 1 Go to the **Support & Drivers menu**, then select your printer model and click on the **Print drivers and Firmware link**.
- 2 Then click on the file for the corresponding print driver.
- 3 Accept the download then save the file in a directory on your hard drive. The firmware is stored compressed as a zip file, which you will need to extract.
- 4 Then double-click on the setup.exe file that you have just downloaded in order to run the installation program.



*For more details about the procedure, please see the **Installing the print driver section**.*

Zenius

4-4 Technical support

If you are having difficulties in configuring and using your printer, read this manual carefully.

If you do not manage to solve your problem, you can obtain further information and help from the Evolis partner network.

4-4a EVOLIS PARTNER NETWORK

For any unresolved technical problem, contact an Evolis dealer. If you do not know any Evolis dealers, visit the www.evolis.com website and send us your question. Evolis will pass on the contact details of your nearest Evolis dealer. When calling an Evolis dealer, you do need to be close to your computer and ready to provide the following information:

- 1 Your printer model and serial number
- 2 The configuration and operating system that you are using
- 3 A description of the incident that has occurred
- 4 A description of the steps that you have taken to resolve the problem.

In addition, to enable you to find answers to your questions 24/7, the www.evolis.com website includes a number of aspects related to day-to-day use of your printer.

4-4b FINDING INFORMATION ON WWW.EVOLIS.COM

If you need additional technical help, you will find a great deal of information on using and troubleshooting Evolis printers under the **Drivers and Support** section on the Evolis website at www.evolis.com.

This section offers downloads of the latest versions of firmware, print drivers and user manuals, videos about using and maintaining Evolis printers, and an FAQ* section giving answers to the most frequently asked questions.

*FAQ: *Frequently Asked Questions*

A

Appendix A

A1 - Technical specifications

This section presents your printer's technical printing properties.

➤ General technical features

- Single side print module, edge-to-edge printing
- Colour sublimation and monochrome thermal transfer
- 300 dpi print head (11.8 dots/mm)
- 16 million colours
- 16MB RAM

➤ Printing speed

Full card print

- YMCKO 120 cards/hour
- Monochrome 400 cards/hour

Maximum speed (under special conditions)

- Colour up to 150 cards/hour
- Monochrome up to 500 cards/hour

➤ Card management and technical data

- Automatic or manual feeder
- Feeder capacity: 50 cards (0.76 mm – 30 mil)
- Output hopper capacity: 20 cards (0.76 mm – 30 mil)
- Card thickness: 0.25 to 0.76mm (10 to 30 mil), adjustment using the gauge
- Card types: PVC and composite PVC cards, recycled PET cards, PET, ABS¹ and special clear overlaid cards¹
- Card format: ISO CR80 - ISO 7810 (53,98 mm x 85,60 mm)

¹ Under specific conditions



A

➤ Ribbons

To maximise the quality and lifetime of the printed cards, the service life of your print head and the overall reliability of your printer, use Evolis High Trust® ribbons.

- Automatic identification and setting
- Ribbon inserted in a cassette to make handling easier
- Graphic notification of the ribbon level (almost finished, finished)
- Integrated ribbon saving for monochrome printing
- Ribbon:
 - YMCKO: 200 prints/roll
 - KO: 300 prints/roll
 - Monochrome ribbons: up to 1000 prints/roll¹
 - Hologram ribbon: 400 prints/roll

¹ Under specific conditions

➤ Ports/connectivity

- USB 1.1 (compatible 3.0)
- Ethernet port available as an option.

➤ Display

- LEDs
- Graphic printer notifications¹:
 - Feeder empty
 - Cleaning alerts
 - Ribbon nearly finished/finished warning
 - Etc.

¹ Dependant on your version of Windows

➤ Software

- Supplied with Evolis Premium Suite® for Windows:
 - Printer driver
 - Evolis Print Center for the administration, management and configuration of the printer
 - Evolis Printer Manager for two-way graphic notification¹
 - Compatible with Windows: XP SP2; Vista 32/64, W7 32/64², W8 32/64
- Supplied with cardPresso XXS Lite
- Other platforms:
 - Mac: on request
 - Linux: on request

¹ Requires .net 4.0 client profile version

² For older versions of Windows, upon request only

Zenius



A

➤ Warranty conditions

- 2 years' warranty (printer and print head)
- Warranty extensions available (contact your Evolis reseller)

➤ Dimensions and weight

- Dimensions (H x W x L): 195 x 205 x 310 mm
- Weight: 3.3 kg

➤ Acoustics (tested in accordance with ISO 7779)

- Sound pressure in assistant positions L_{pAm} (colour mode YMCKO)
 - In operation: 46 dB (A)
 - Standby mode: background noise level

➤ Security

- Kensington® security lock
- Data encryption for magnetic encoding¹

¹ Available for the 'Expert' range and above

➤ Eco-design and certifications

- Standby mode and reduced power consumption
- Printer meets the Energy Related Products Directive, ErP, 2009/125/EC

➤ Contents of the packaging

- Printer
- CD-ROM with printer driver, user manuals
- cardPresso XXS Lite
- Cleaning equipment
- USB cable
- Power supply unit
- Power supply lead (differs according to region)

Zenius



A

➤ Options & accessories

- Colours available: Fire red and Grey Brown
- Ethernet TCP-IP¹
- Encoding options¹
 - Can be combined, fitted on site using additional modules¹
 - Magnetic stripe encoder
 - Chip contact station
 - Smartcard encoder
 - Contactless card encoder
 - Others on request

¹ Available for the 'Expert' range and above

➤ Certifications and declaration of conformity

- CE, FCC, IEC, VCCI, CCC, KC
- ErP 2009/125/CE, RoHS
- 13.56 MHz, PLL/ASK/semi-duplex operation

➤ Power supply

- Power supply module: 100-240 Volts AC, 50-60 Hz, 1.7A
- Printer: 24 Volts DC, 2,7 A

➤ Environment

- Min/max operating temperature: 15° / 30 °C (59° / 86 °F)
- Humidity: 20% to 65% without condensation
- Min/max storage temperature: -5° / +70 °C (23° / 158 °F)
- Storage humidity: 20% to 70% without condensation
- Ventilation in operation: open air

Zenius

B

Appendix B

B1 - Compliance statements

In this section, you will find the certifications for your Evolis printer.

Compliance statements

Concerning Safety and Electromagnetic Compatibility of Radio Equipment (R&TE 1999/5/CE, 2006/95/CE and 2004/108/CE Directives)

Manufacturer name: Evolis Card Printer
Manufacturer address: 14, avenue de la Fontaine
Z.I. Angers Beaucouzé
49070 Beaucouzé, France

Equipment name: Zenius
Year of manufacture: 2013

I, the undersigned,
Serge Olivier,

Declare under my own responsibility, that the product described above complies with the essential applicable requirements of the 1999/5/CE, 2006/95/CE and 2004/108/CE directives:

Article 3.1 b: (electromagnetic compatibility protection requirement)

Safety standard applied EN60950-1:2006 + A11:2009 + A1:2010 + A12:2011
EN50364:2001
EN62311:2008

Article 3.1 b: (electromagnetic compatibility protection requirements)

EMC standard applied EN55022:2006 + A1
EN55024:1998 + A1 + A2
EN61000-3-2:2006
EN61000-3-3:2008
EN301489-3:V1.4.1



Article 3.2: (Good use of the radio frequency spectrum to avoid undesirable interferences)

EMC standard applied EN302291-2 V1.1.1

Full name: Serge Olivier
Position: R&D Director
Date: 2013

Signature:

EUROPE - Norway Only: This product is designed for IT power system with phase-to-phase voltage 230V. Earth grounding is via the polarized, 3-wire power cord.
FI: "Laite on liitettävä suojamaadoitus koskettimilla varustettuun pistorasiaan"
SE: "Apparatens skall anslutas till jordat uttag"
NO: "Apparatet må tilkoples jordat stikkontakt"

FCC Federal Communications Commission notice Radio frequency interference in the United States



The Zenius model complies with the following specification: FCC Part 15, Subpart A, Section 15.107(a) and Section 15.109(a) Class B Digital device.

Additional information:

This equipment has been tested and found to comply with the limits for a Class B digital device, pursuant to part 15 of the FCC Rules. These limits are designed to provide reasonable protection against harmful interference in a residential installation. This equipment generates, uses and can radiate radio frequency energy and, if not installed and used in accordance with the instructions, may cause harmful interference to radio communications. However, there is no guarantee that interference will not occur in a particular installation. If this equipment does cause harmful interference to radio or television reception, which can be determined by turning the equipment off and on, the user is encouraged to try the following measures:

- Reorient or relocate the receiving antenna.
- Increase the distance between the equipment and the radio or television.
- Connect the equipment to a circuit other than that to which the receiver is connected.
- Consult the supplier or an experienced radio/TV technician.

Use of a shielded twisted pair cable is necessary to comply with the restrictions laid down by part 15 of the FCC Rules for Class B digital devices.

Pursuant to Part 15.21 of the FCC Rules, any changes or modifications made to this equipment without the express, written consent of Evolis Card Printer may cause harmful interference and void the FCC authorisation to operate this equipment.

It is recommended to respect a distance of 20 cm between user and RFID module when the module is powered.

It is recommended to respect a distance of 20 cm between user and RFID module when the module is powered.

This device complies with the Industry Canada CNRs applicable to licence-exempt audio devices. Their use is authorised subject to the following two conditions: (1) the device must not cause interference and (2), the user of the device must accept any radio interference to which they may be subject even if the jamming is liable to adversely affect operation.

Japanese radio frequency interference (VCCI)



This equipment is Class B information technology equipment based on the rules laid down by the Voluntary Control Council For Interference by Information Technology Equipment (VCCI). Its use in or close to a residential area may cause radio interference, in which case, you must take appropriate steps.

この装置は、情報処理装置等電波障害自主規制協議会（VCCI）の基準に基づくクラスB情報技術装置です。この装置は、家庭環境で使用することを目的としていますが、この装置がラジオやテレビジョン受信機に近接して使用されると、受信障害を引き起こすことがあります。
取扱説明書に従って正しい取り扱いをして下さい。



이 기기는 업무용(A급) 전자파적합기기로서 판매자 또는 사용자는 이 점을 주의하시기 바라며, 가정외의 지역에서 사용하는 것을 목적으로 합니다.

Zenius

C

Appendix C

C1 - Encoding options

Some models of Evolis printers are equipped with encoding systems which are used to customise magnetic strips, and contact and contactless smartcards.

With Zenius Expert, it is possible to install up to three types of encoder in the printer (magnetic stripe, contact and contactless smartcards).

C1a - MAGNETIC STRIPE ENCODING

A printer fitted with a magnetic encoder works in exactly the same way as a basic card printer. The Evolis encoder encodes the magnetic stripes in a single pass then runs a data check.

Although able to be configured as high coercivity (HiCo) or low coercivity (LoCo) by a simple click in Evolis Print Center, Evolis magnetic encoders come factory set for high coercivity (HiCo).

➤ Location of the magnetic encoder

The magnetic encoder is a module installed either in the factory or on site by your Evolis dealer. The read and write head is located under the path taken by the cards and before the print head. The encoding sequence for a card is always carried out before the printing.



***Use only magnetic stripe cards that comply with ISO 7810 and ISO 7811 standards.
The magnetic stripe must be moulded into the card to work properly.
Never use cards with a glued-on magnetic stripe.***

Zenius



C

> Card positioning

Magnetic stripe cards must be placed in the card feeder so that the magnetic stripe is facing downwards as shown below:

- 1 Open the printer card feeder as shown.
- 2 Insert a maximum of 50 cards of thickness 0.76 mm. Hold the cards as shown in the diagram (magnetic stripe downwards).
- 3 Close the feeder.



Zenius



C

► Configuring the Evolis Print Center

When first installing the Evolis Print Center, the magnetic encoder functions need to be configured. The magnetic encoder functions may be accessed from the Evolis Print Center Properties by right-clicking the name of the printer.

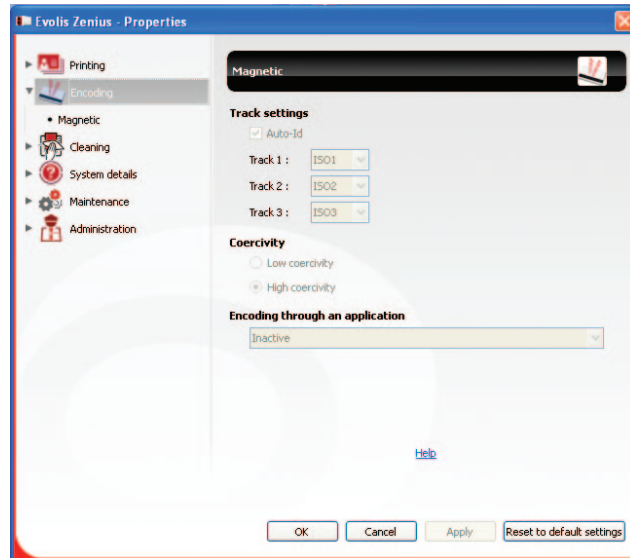

► «Magnetic Encoder» dialogue box

The **Magnetic Encoding** dialog box is opened by clicking **Encoding** followed by **Magnetic**.

Configure stripes allows you to select the desired format for each stripe. See the table in this Appendix for information regarding ISO 7811 standards.

Coercivity sets the magnetic encoding to high (HiCo) or low (LoCo) coercivity. A magnetic stripe that is encoded with high coercivity is more resistant to external disturbance than a magnetic stripe encoded using low coercivity.

Encoding via an application is used to encode magnetic stripe cards from applications under Windows (such as Word for example). A text field enclosed within “|” and “|” characters (or some other character which the user can define) will be interpreted as an encoding command by print driver.

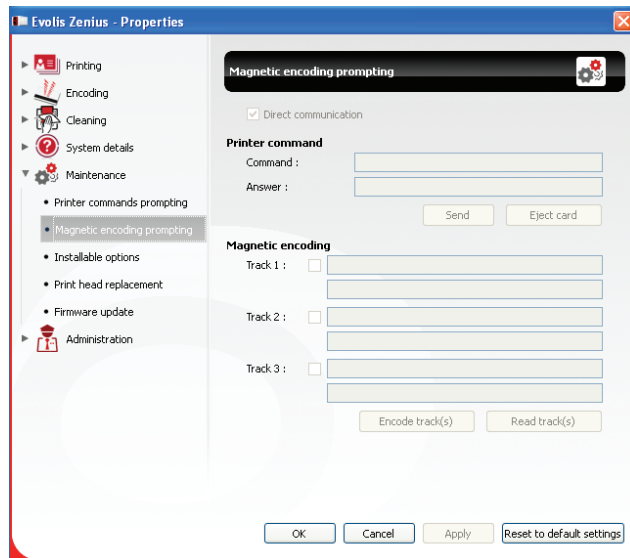

Selecting **Maintenance** then **Dialog with the magnetic encoder, Magnetic encoding** allows one or more magnetic stripes to be directly encoded from this window simply by selecting them and entering the data to be encoded. Click on the **Encode stripe(s)** button to run the encoding cycle.

Zenius



C

► Cleaning the magnetic encoder

The magnetic encoder head requires regular maintenance in order to ensure the integrity of the data encoded onto cards. Cleaning of the magnetic encoder is carried out when the printer runs an advanced cleaning sequence with impregnated «T» cards (see the “Maintenance” section of this manual for further information).

Repeatedly running the cleaning card through the printer cleans the card feed rollers, the cleaning rollers, the print head and the magnetic encoder read-write head.

If, in between two routine printer cleaning runs (every 1000 cards inserted), the read-write process fails with more than one card, it is recommended to run an advanced printer cleaning sequence manually (please see the “Maintenance” section of this manual for the procedure to follow).

► ISO 7811 magnetic encoding standards

Stripe number	Separator	Density	Character set	Number of characters
Stripe 1	^	210 ppp ¹	Alphanumeric (ASCII 20-95) ²	79 ³
Stripe 2	=	75 ppp ¹	Numeric (ASCII 48-62) ²	40 ³
Stripe 3	=	210 ppp ¹	Numeric (ASCII 78-62) ²	107 ³

¹ Dots per inch

² Except for the “?” character

³ Including the Start, Stop and LRC characters These characters are automatically handled by the magnetic encoder

C

C1b - CONTACT SMARTCARD ENCODING

A printer fitted with a smartcard contact station works in exactly the same way as a basic card printer. The Evolis smartcard contact station is used to program chips to ISO 7816-2 standards.

► Contact station location

The contact station is a module installed either in the factory or on site by your Evolis dealer. It is located over the path taken by the cards and after the print head. To contact the smartcard, the contact station descends mechanically against the smartcard. The programming sequence for a chip is always carried out before the card is printed.



*Use only smartcards compliant with the ISO 7816-2 standard.
Never print over the chip.*

Zenius



C

► Card positioning

Smartcards must be placed in the card feeder so that the chip contact is facing upwards as shown below:

- 1 Open the printer card feeder as shown.
- 2 Insert a maximum of 50 cards of thickness 0.76 mm (smartcard contact upwards). Ensure the cards are positioned as illustrated in the diagram.
- 3 Close the card feeder.

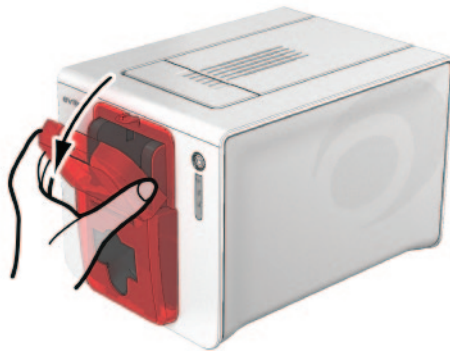
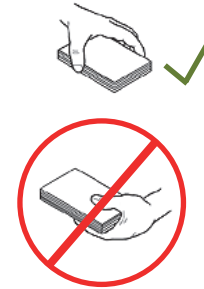

1

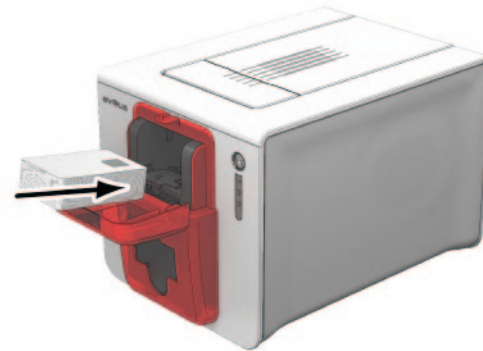

2



3

Zenius



C

➤ Contact station interface

Printers fitted only with a smartcard contact station (without integrated encoder) are fitted with a female DB-9 connector which is found on the back of a printer. This connector, directly connected to the contact station inside the printer, is also connected to an external coupler to program the chip.



DB-9 connector pins	Smartcard contact points
1	C1 (V c.c.)
2	C2 (reset)
3	C3 (clock)
4	C4 (reserved)
5	C5 (ground)
6	C6 (Vpp)
7	C7 (I/O)
8	C8 (reserved)
9	Card present signal

A sequence of commands must be sent via the printer's interface to insert a card into the printer then position it under the station and establish contact.

Zenius



C

➤ The command sequence is as follows:

Sending the SIS sequence:

- A card is moved from the feeder to the contact station, and stops underneath it.
- The contact station is pushed downwards to make contact with the card.
- The printer connects the contact station to the DB-9 connector.
- The chip can be programmed via the external coupler.



Refer to the Programming Guide for the Evolis printer for more information on programming a smartcard and the Option installation manual for configuration of the card present signal.

The Evolis product catalogue also includes printers equipped with a chip contact station and a built-in encoder. These encoders connect to the PC via a USB interface.

Zenius

C

C1c - CONTACTLESS SMARTCARD ENCODING

Evolis printers may be equipped with an encoding device for contactless smartcards (RFID). This consists of an encoding module and a built-in antenna.

A module such as this must be installed by a specialist. The Evolis product catalogue includes printers equipped with a built-in encoder for contactless chips.

This encoder connects to the PC via a USB interface.

There is a very wide variety of contactless smartcards, and each card has specific technical properties associated with an equally specific type of encoder. See your Evolis dealer for further information.

➤ Location of the antenna (or the encoder including an antenna)

By means of a specific command, the card is positioned close to the antenna such that the card lies within its radio range.

Reading data from or writing data to the card can then start.

The programming sequence for a chip is always carried out before the card is printed.

➤ Card positioning

There is in theory no restriction on card positioning when programming in contactless mode.

However, the miniaturisation of components is bringing about the emergence of cards fitted with mini-antennae.

If this is the case, please see your card supplier for further information about where such mini-antennae are located within the card, so as to position the card as close as possible to the encoder's antenna. Doing so will ensure optimum encoding of the cards.

Zenius



C

➤ Computer connection

If your encoder is supplied with an USB interface, it will either be connected to the printer's internal USB Hub, or equipped with a USB cable to connect to your computer directly.

In the first case, your printer's USB cable is used to drive firstly the printer and secondly the encoder from the computer.

If your encoder is supplied with an RS-232 interface, it needs to be connected to the computer via a serial cable. This cable plugs into the printer's female DB-9 socket, and into a COM port on the computer.

DB-9 connector pins	RS-232 signals (serial)
1	Not used
2	RxD
3	TxD
4	Not used
5	GND
6	Not used
7	RTS
8	CTS
9	Not used

A sequence of commands must be sent via the printer's interface to insert a card in the printer then position it close to the antenna to establish radio communication between the card and the encoder.

The command sequence is as follows:

Sending the SIC sequence:

- A card is moved from the feeder towards the antenna and is positioned nearby.
- The chip is programmed via the computer's serial (or USB) interface connecting the built-in encoder and the computer.



Refer to the Evolis Programming Guide for further details on programming contactless smartcards.

Zenius