

Q-POS 815

Wireless Touch POS Terminal

Socket 478, Pentium 4

15" Touch TFT



User's Guide

Copyright Notice

This document is copyrighted, 2006 by Heisei Electronics Co., Ltd. The information provided in this document has been carefully checked for accuracy at the time of publication. No representations or warranties, either expressed or implied, with respect to the contents hereof and specifically disclaims any warranties, merchantability, or fitness for any particular purpose.

This User's Guide requires higher than basic understanding of computer and Q-POS installation and configuration, and provides technical assistance for system and network administrators deploying the Q-POS. Any software described in this manual is sold or licensed "as is". Should the programs prove defective following their purchase, the buyer assumes the entire cost of all necessary servicing, repair, and any incidental or consequential damages resulting from any defect in the software.

Heisei Electronics Co., Ltd. reserves the right to revise this publication and to make changes from time to time in the contents hereof without obligation to notify any person of such revision or changes. No part of this publication may be reproduced, stored in a retrieval system, or transmitted in any form of or via any means, without the prior written permission of Heisei Electronics Co., Ltd.

Trademarks

All brand, company, and product names used for identification in this document are trademarks or registered trademarks of their respective companies.

© Copyright 2006, Version 1.1

All rights reserved.

Printed in Taiwan

Unpacking the Q-POS

After unpacking the Q-POS carton, check to make sure all the following items are included and in good condition.

Q-POS system	x 1
Accessories:	
AC Power Cable	x 1
Utility CD with drivers and user guide	x 1
Pair of keys for opening front panel	x 1

Make sure that all of the items listed above are present. If any of the above items is missing, contact your supplier immediately.

Warranty

All products are warranted against defective materials for one year starting from the date of delivery to the original buyer. Contact your supplier for a copy of the Warranty Policy & RMA Form or go to <http://www.heisei.com.tw/faq>

Important Safety Precautions

1. Before getting started, read these instructions and save them for later reference.
2. Turn off the Q-POS before cleaning. Clean with a damp or dry cloth only. Do not spray any liquid cleaner directly on the screen.
3. The power outlet socket used to plug in the computer power cord must be located near the system and easily accessible. Do not use outlets on the same circuit of other systems that are regularly switched on and off.
4. If the Q-POS is sharing an extension cord with other devices, make sure the total ampere rating of the devices plugged into the extension cord does not exceed the cord's ampere rating.
5. Do not expose the power cord, extension cord and power outlet to moisture or traffic intensive walkways.
6. Mount the Q-POS only on sturdy and reliable surfaces to prevent damage caused by dropping.
7. Disconnect the power cord from the computer before any installation of internal components. Make sure both the computer and the external devices are turned off. A sudden surge of power may damage sensitive components. Also make sure the computer is properly grounded.
8. If an operating system is not installed, an operating system must be loaded first before installing any software into the Q-POS.
9. During installation of any internal components, be sure to discharge any static electricity by using a grounding wrist strap, and placing all electronic components in any static-shielded devices. If a wrist-grounding strap is not available, briefly touch an unpainted piece of metal.
10. The openings on the Q-POS enclosure are for the cabin ventilation to prevent the computer from overheating. **DO NOT COVER THE VENTILATION OPENINGS.**
11. The brightness of the flat panel display will decrease with use over long periods of time. However, hours of use will vary depending on the application environment.

12. If the Q-POS is equipped with a touch panel, avoid using sharp or metallic objects to operate the touch panel. Scratches on the touch panel may cause mal-calibration or serious damage to the panel.
13. The LCD panel display is not resistive to shock or vibration. If re-assembling the Q-POS, make sure the LCD panel is properly and securely installed.

Table of Contents

1.	INTRODUCTION	1-1
1.1	GENERAL INFORMATION	1-1
1.2	SPECIFICATIONS	1-2
1.3	DIMENSIONS.....	1-4
2.	USING THE SYSTEM.....	2-5
2.1	IDENTIFYING THE SYSTEM	2-5
2.1.1	<i>FRONT VIEW.....</i>	<i>2-5</i>
2.1.2	<i>DIAGRAM OF FRONT PORTS.....</i>	<i>2-6</i>
2.1.3	<i>REAR VIEW.....</i>	<i>2-6</i>
2.1.4	<i>REMOVEABLE REAR BASE PANEL.....</i>	<i>2-7</i>
2.1.5	<i>DIAGRAM OF REAR CONNECTOR IO PORTS.....</i>	<i>2-7</i>
2.2	<i>FIRST TIME SYSTEM SETUP</i>	<i>2-8</i>
2.2.1	<i>OPENING THE REAR SYSTEM PANEL</i>	<i>2-8</i>
2.2.2	<i>INSTALLING THE CPU.....</i>	<i>2-9</i>
2.2.3	<i>INSTALLING A MEMORY MODULE</i>	<i>2-9</i>
2.2.4	<i>INSTALLING A SLIM CD-ROM, DVD-ROM, HDD</i>	<i>2-10</i>
2.2.5	<i>HARDWARE INSTALLATION PROCEDURES.....</i>	<i>2-12</i>
2.2.6	<i>SYSTEM BIOS SETUP</i>	<i>2-12</i>
2.2.7	<i>OPERATING SYSTEM AND DRIVER INSTALLATION</i>	<i>2-13</i>
3.	MAIN BOARD SETTINGS.....	3-14
3.1	JUMPER SETTINGS	3-14
3.2	CONNECTORS	3-16
4.	INPUT/OUTPUT CONNECTIONS.....	4-26
4.1	FLASH MEMORY CARD READER / WRITER.....	4-26
4.2	HYBRID SWIPE CARD READER	4-26
4.3	USB 2.0 PORTS	4-27
4.4	SERIAL / COM PORTS.....	4-27
4.5	ETHERNET 100/10 BASE-T LAN (RJ-45)	4-28
4.6	VGA INTERFACE.....	4-28
4.7	PS/2 KEYBOARD INTERFACE	4-29
4.8	PS/2 MOUSE INTERFACE	4-29
4.9	LPT PRINTER PORT.....	4-29
4.10	AUDIO INTERFACE (LINE/SPK-OUT).....	4-29
4.11	RJ-11 CASH DRAWER PORT.....	4-30

5.	AWARD BIOS SETUP	5-31
5.1	AWARD BIOS	5-31
5.2	CONTROL KEY DEFINITION	5-32
5.3	GETTING HELP	5-33
5.4	AWARD BIOS SETUP	5-33
5.4.1	<i>AWARD BIOS SETUP MAIN MENU</i>	5-33
5.4.2	<i>STANDARD CMOS FEATURES</i>	5-35
5.4.3	<i>ADVANCED BIOS FEATURES</i>	5-37
5.4.4	<i>ADVANCED CHIPSET FEATURES</i>	5-38
5.4.5	<i>INTEGRATED PERIPHERALS</i>	5-38
5.4.6	<i>POWER MANAGEMENT SETUP</i>	5-39
5.4.7	<i>PNP/PCI CONFIGURATION</i>	5-39
5.4.8	<i>PC HEALTH STATUS</i>	5-40
5.4.9	<i>FREQUENCY VOLTAGE CONTROL</i>	5-40
6.	SOFTWARE & DRIVER INSTALLATION.....	6-41
6.1	AUDIO	6-41
6.2	HYBRID SWIPE CARD READER	6-41
6.3	ETHERNET LAN.....	6-44
6.4	TOUCH SCREEN	6-44
6.5	USB 2.0	6-44
6.6	VGA VIDEO.....	6-44
6.7	WIRELESS LAN	6-45
7.	TOUCH SCREEN (ELO).....	7-46
7.1	INTRODUCTION	7-46
7.2	CONSTRUCTION.....	7-46
7.3	FEATURES.....	7-47
7.4	SPECIFICATIONS	7-48
7.5	ELO TOUCH SCREEN SOFTWARE DRIVER.....	7-48
7.6	TOUCH SCREEN CARE AND CLEANING	7-49
7.7	TROUBLESHOOTING	7-49
7.7.1	<i>DISPLAY PROBLEMS</i>	7-50
7.7.2	<i>SOFTWARE TROUBLESHOOTING</i>	7-50
7.7.3	<i>VIDEO ALIGNMENT PROBLEMS</i>	7-51
7.7.4	<i>HARDWARE TROUBLESHOOTING</i>	7-51

1. INTRODUCTION

1.1 General Information

HEISEI's latest Q-POS 815 series compact platform is a fashionable and powerful P4 POS system designed with a 15" TFT LCD and 5-wire Touch Panel.

The Q-POS features a robust IPC single board, supplying power and utilizing features of peripherals connected through any of its host of IO ports: RS-232, Power USB (24V & 12V), and Digital IO (cash drawer). The DC24V power USB outlet supports POS printer and Multi Card Reader/Writer. These excellent specifications are powerful enough to support all the latest retail requirements and POS peripheral products.

The Q-POS is designed for high-end use in restaurants, clubs, clothing stores, and other high-traffic retail environments. With HEISEI's Q-POS 800 series, servicing time is reduced while and efficiency and profits are dramatically increased.

1.2 Specifications

CPU Support	Intel® Pentium® 4 processor up to 3.06GHz, FSB 533/400/333MHz
Main board	Flex-845P Industry Main Board
Colors	White or Black
LCD Size	15" TFT LCD 250 nits
Resolution	1024 x 768 XGA
Touch Screen	5-Wire resistive anti-glare surface treatment
Main Chipset	North Bridge: Intel® 845gv Chipset
	South Bridge: Intel® 82801 DB ICH4 Chipset
System Memory	1 x 184pin DDR RAM socket up to 1GB, supports PC 333/266/200
Storage Devices	3.5" Hard Disk Drive 1 x Slim type CD-ROM/DVD-ROM (optional) 1 x Multi Flash Card Reader/Writer supports: SD/MMC/CF/SM/MS/Micro (optional)
Graphics	Integrated VGA/LCD display controller, video memory up to 64MB (shares system memory) 2D/3D GUI engine, AGP 4X VGA, MPE-4/MPEG-2 playback
Watchdog Timer	256-level
LED Indicator	Power, LAN, HDD
Audio/ Speaker/ Key Lock	ICH4 integrated audio with AC97 CODEC; Built-in stereo speakers on front panel / bezel
I/O Ports	6 x COM Ports: 1,2,4: RS-232 9pin D-SUB male, +5/+12V output by jumper, COM 5 (Normal); COM 3: Reserved for Touch Screen, COM 6: on board 1 x LPT 25-pin D-SUB Connector 6 x USB 2.0 (2 USB on rear bezel, 1 USB on front

	bezel, 3 x pin header) DC12V USB and DC24V Power USB Connector 1 x Line-in, 1 x Line-out, 1 x Microphone-in (inside the rear system panel) 1 x PS/2 Keyboard, 1 x PS/2 Mouse 1 x RJ11 Cash Drawer 12V or 24V Solenoid type 1 x VGA D-SUB 15 monitor port 1 x RJ45 LAN (10/100 Base-T on board)
Construction	Inside: heavy-duty steel; Outside: ABS fire-proof resilient plastic
Temperature	Operating 0°C~45°C, Storage -20°C~60°C
Relative Humidity	10~90%, non-condensing
Tilt Angle	10°~85° for both desk-top and wall mount without additional parts
Vibration	5~7Hz, 0.1" double amplitude displacement, 17~500Hz, 1.5G acceleration peak to peak
AC Power Supply	ATX 250W Power Supply, 100~240V
Operating System	DOS, Windows 2000, XP, XP Embedded, WEPOS
Dimensions	365 (W) x 351(H) x 343 (D) mm
Weight	8.1kgs
Safety & EMI	UL, FCC, CE
Options	Hybrid Swipe Card Reader (IC Card + MSR Track 1/2/3 + i-Button) Single Card Reader Track 1/2/3 56K Modem Integrated (RS232 Interface) Customer Display: FD-202 VFD/FD-304 LCD Pole Display (RS-232 Interface) Wireless LAN device IEEE 802.11g (on board USB)

1.3 Dimensions

The chassis sizes (in mm) are shown below.

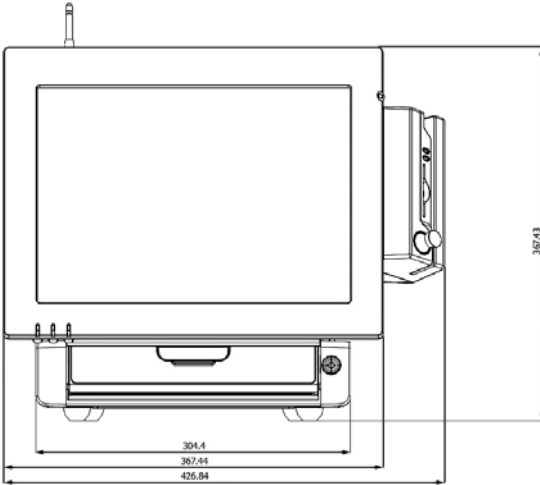

FIGURE 1-1: Q-POS
FRONT VIEW
DIMENSIONS (WITH
OPTIONAL HYBRID
CARD READER ON
FRONT RIGHT SIDE)

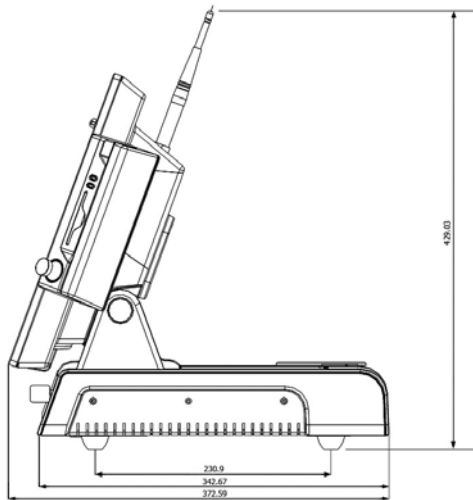

FIGURE 1-2: Q-POS
RIGHT SIDE VIEW
DIMENSIONS

2. USING THE SYSTEM

2.1 Identifying the System

Before getting started, take a moment to familiarize yourself with the Q-POS system.

2.1.1 Front View

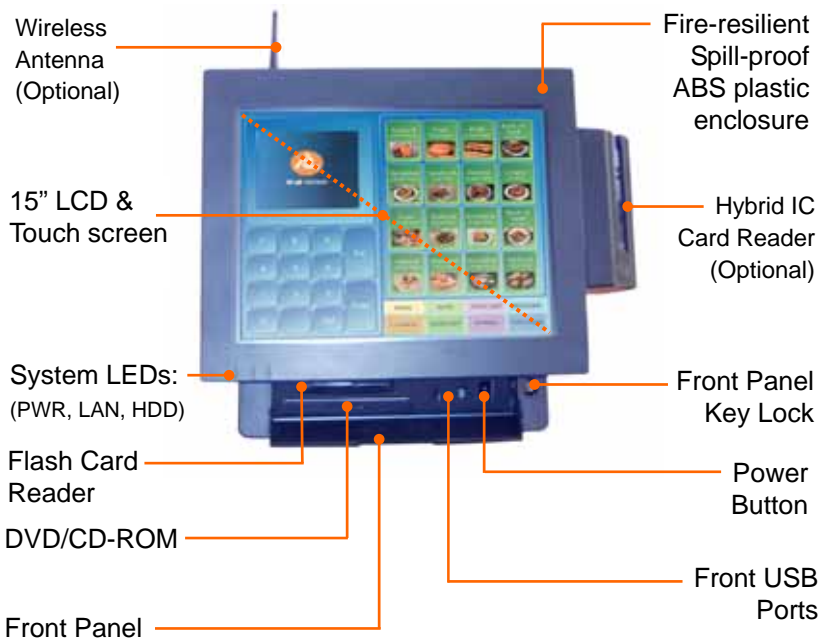

FIGURE 2-1: Q-POS FRONT VIEW

2.1.2 Diagram of Front Ports

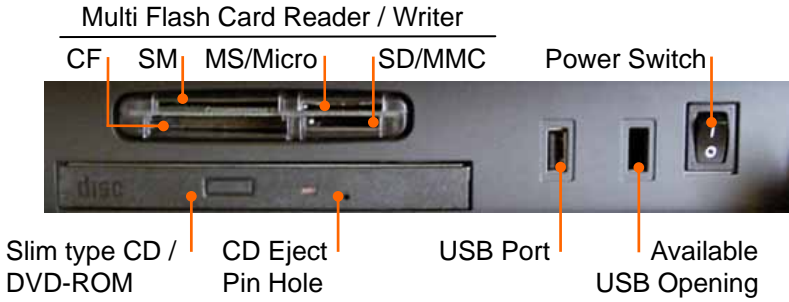

FIGURE 2-2: Q-POS FRONT PANEL

2.1.3 Rear View

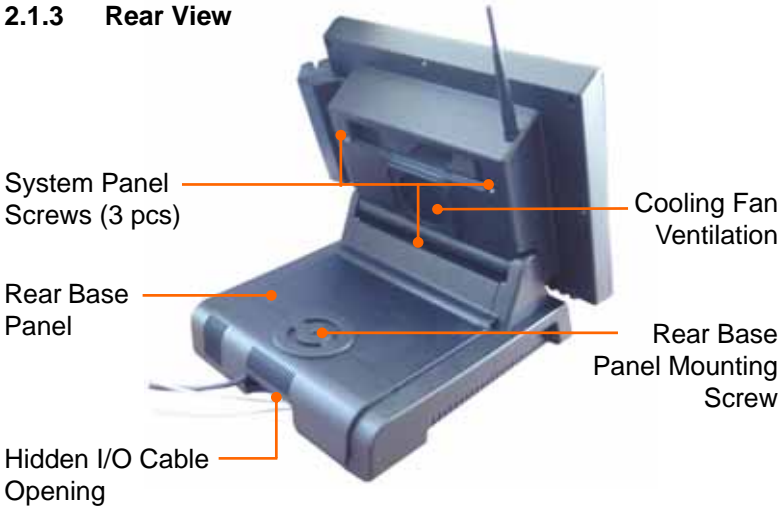

FIGURE 2-3: Q-POS REAR VIEW

2.1.4 Removeable Rear Base Panel

At the rear of the Q-POS, by unscrewing and lifting off the rear base panel, the cable connectors and I/O ports can be located.

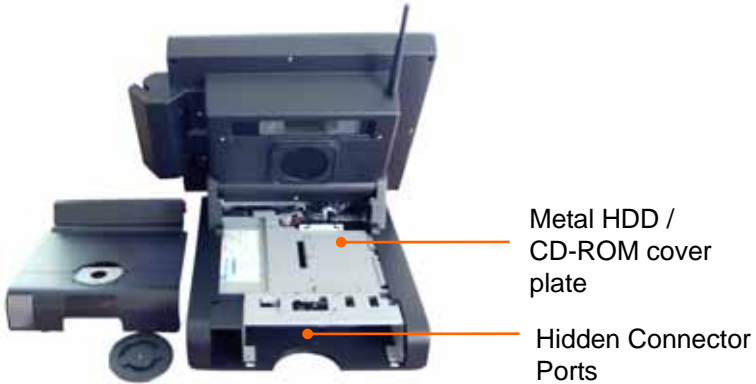
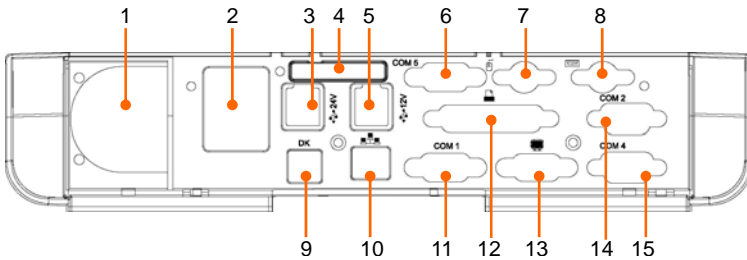

FIGURE 2-4: Q-POS REAR BASE PANEL REMOVED

2.1.5 Diagram of Rear Connector IO Ports



- | | | | |
|------------------|-------------------|--------------------|------------------|
| (1) PSU Fan | (5) USB 12V | (9) Cash Drawer | (13) VGA Monitor |
| (2) AC Power | (6) COM 5 | (10) Ethernet LAN | (14) COM 2 |
| (3) USB 24V | (7) PS/2 Mouse | (11) COM 1 | (15) COM 4 |
| (4) Upgrade Slot | (8) PS/2 Keyboard | (12) Parallel Port | |

FIGURE 2-5: Q-POS REAR CONNECTOR IO PORTS

2.2 First Time System Setup

To set up the Q-POS for the first-time, you should have the following items ready. These items are either included in the accessory box or available from your local computer parts store.

- Q-POS Utility CD (Included)
- Power cord (Included)
- PS/2, AT or USB Keyboard (Not included)
- PS/2 or USB Mouse (Not included)
- Bootable Operating System (OS) Installation CD (Optional)

If the Q-POS system hardware (i.e. CPU, HDD, RAM, CD-ROM) has already been installed, please skip to section 2.2.5. If a CPU and cooling fan, DDR RAM, DVD / CD-ROM, and/or HDD needs to be installed, please refer to the following instructions.

2.2.1 Opening the Rear System Panel

After removing the 3 system panel screws (see figure 2-3), carefully remove the metal main board cover plate to expose the main board. Be sure to keep the screws in a secure place.

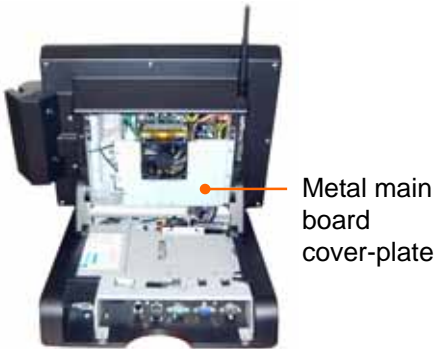

FIGURE 2-6: Q-POS REAR SYSTEM PANEL, WITH CPU AND FAN INSTALLED



FIGURE 2-7: MAIN BOARD WITH CPU, FAN AND RAM INSTALLED

2.2.2 Installing the CPU

The Q-POS 845P main board provides 1 x Socket 478 processor connector for 1 x Pentium 4 CPU from 1.7G to 3.06GHz. To access the CPU socket, remove the rear system panel. The socket comes with a lever to secure the processor. Raise this lever to about a 90° angle to allow the insertion of the processor. Place the processor into the socket by making sure the notch on the corner of the CPU corresponds with the notch on the inside of the socket. Once the processor is properly fitted on the socket, return the lever to the lock position, as seen in figure 2-8.

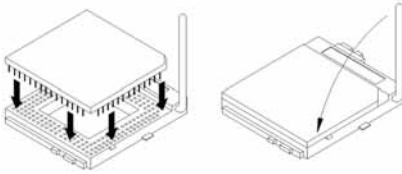

FIGURE 2-8: CPU INSTALLATION

NOTE: Be sure to follow the CPU fan installation instructions and ensure the fan and top surface of the CPU are in total contact using silicon gel to prevent the CPU from overheating, which would cause unstable system performance.

2.2.3 Installing a Memory Module

The Q-POS main board provides 1 x 184-pin DDR DIMM socket, able to support 1 x DDR SDRAM memory up to 1GB (PC 333/266/200). To install the memory module, follow these instructions:

1. Make sure the Q-POS is turned off and unplugged from the AC outlet.
2. Inside the rear system panel (see figure 2-3), and the metal housing plate. The 184 pin DDR DIMM socket is found on the right side of the main board.
3. There are two white eject levers at each end of the DDR DIMM socket. Push them outward until they separate from the two vertical posts.
4. Due to the space restrictions of the system panel, it is extremely important to carefully move aside any cables which may be obstructing the DDR slot on the main board. Holding the memory

module with the notch on the upper right corner, carefully insert the memory module into the DIMM socket.

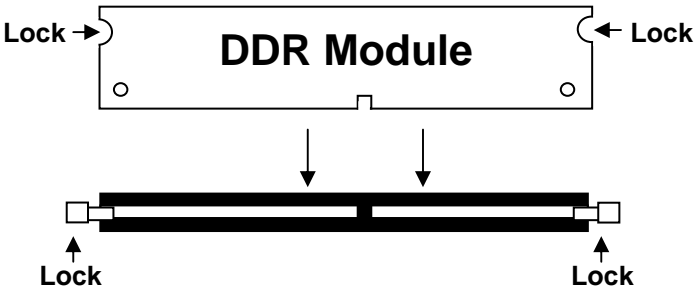

FIGURE 2-9: Q-POS REAR CONNECTOR PORTS

5. Push the two eject levers toward the vertical posts of the DDR DIMM until they click into place. The memory module should be seated 90° to the main board at both ends.

No hardware or BIOS setup is required after adding or removing memory, as the system will auto detect the new memory module(s).

2.2.4 Installing a slim CD-ROM, DVD-ROM, HDD

Underneath the rear base panel (as seen in figure 2-4), the metal HDD / CD-ROM cover plate will need to be removed to access the chamber where the slim type DVD or CD-ROM and HDD can be installed. First install the slim type DVD or CD-ROM in the bottom of the interior frame.

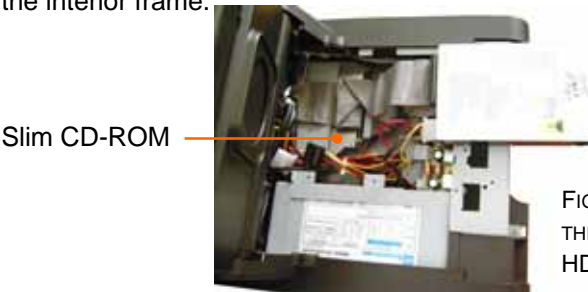

FIGURE 2-10: INSTALLING THE DVD / CD-ROM AND HDD

With the middle connector of the IDE cable connected to the HDD, and the end connector to the DVD / CD-ROM, the extra IDE cables should be carefully tucked in the rear of the frame, and folded above the DVD / CD-ROM to make room for the HDD to rest on top.

IDE cables
carefully tucked



FIGURE 2-11:
TUCKING THE
IDE CABLES

IDE cables
carefully folded



FIGURE 2-12:
FOLDING THE
IDE CABLES

HDD carefully
seated on top of
the folded IDE
cables



FIGURE 2-13:
FINAL HDD
INSTALLATION

2.2.5 Hardware Installation Procedures

Prior to turning the power on, connect the input devices and power cable.

1. Connect a PS/2 keyboard or AT keyboard to the PS/2 keyboard port, or a USB keyboard to a USB port. If you are using an AT keyboard, you need an adapter (AT to PS/2 KB) for this connection. While the main board supports USB keyboards, Windows 98 installation may have difficulty detecting USB keyboards.
2. Connect the PS/2 mouse to the PS/2 mouse port, or a USB mouse to a USB port.
3. Connect the female end of the power adapter cord to the AC inlet located at the left rear side of the Q-POS.
4. Connect the male end of the power cord to an electrical outlet.

2.2.6 System BIOS Setup

Commercial users should find the Q-POS already set-up and pre-configured by the distributor. In case it is necessary to change some system configuration information, the Basic Input Output System or Basic Integrated Operating System (BIOS) setup program is accessible upon system start-up. Under the following conditions, the BIOS settings may be changed:

1. The system is starting and being configured for the first time with new components.
2. The hardware devices attached to the Q-POS system have been changed.
3. The BIOS memory has lost power and the configuration information has been erased.

The BIOS setup program is stored in ROM, which can be accessed by pressing key on the keyboard immediately when the system is powered on.

In order to retain the specified setup information when the system power is turned off, the system setup information is stored in a battery-backed CMOS RAM. The battery is to ensure the settings will not be erased when the computer is turned off or reset. When the computer is powered on again, the system will read the settings stored in the CMOS RAM and compare them to the equipment check conducted during the power on self-test (POST). If any error or mismatch occurs, an error message will be shown on the screen and the computer will be prompted to run the setup program.

2.2.7 Operating System and Driver Installation

The standard Q-POS system may not be equipped with an operating system (OS). If you are a commercial user, the system is likely to have been pre-installed with a proper operating system and software drivers by your dealer or system integrator. If the system is not pre-installed with an OS and drivers, they will need to be installed.

Recent OS releases include setup programs that load automatically from bootable CD-ROMs, and guide user's through complete installation. Reference to the OS user manual for instructions on formatting or partitioning the hard disk drive before any software installation is advised.

When the system boots up for the first time with the new operating system installed, the software drivers need to be installed. The Q-POS Utility CD includes software for the Audio driver, Hybrid Card Reader, LAN driver, Touch Screen (drivers), USB 2.0 driver (Win XP requires SP1 or later), VGA Display drivers and Wireless LAN.

3. MAIN BOARD SETTINGS

This section describes the 845P main board jumper and connector settings.



3.1 Jumper Settings

Below are the functions and values of the jumpers found on the Flex-845E main board:



J2: External Speaker Connector

Pin	Signal Name	J2	Signal Name	Pin
1	L_OUT_R		L_OUT_L	2
3	HP_IN		GND	4
5	MIC		GND	6



JP1: Select Clock (1-2=CPU Clock, 2-3=100Mhz) *Default 1-2

JP1	FBS Clock
	CPU Clock (default)
	100Mhz

JP2: LVDS Panel Power Select

JP2	LVDS Panel Power
	3.3V (default)
	5V

JP3: 1-2 = Clear CMOS, 2-3 = Normal

JP16	LVDS Panel Power
	Clear CMOS
	Normal (default)

JP5: Used for an optional IrDA connector for wireless communication.

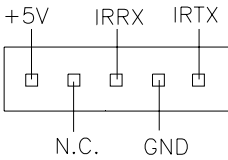

Pin	Signal Name
1	+5V
2	No connect
3	Ir RX
4	Ground
5	Ir TX

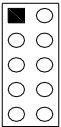

JP6: Digital 4-in 4-out I/O Connector



Signal Name	Pin	Pin	Signal Name
Ground	1	2	Vcc
Out3	3	4	Out1
Out2	5	6	Out0
Int3	7	8	Int1
Int2	9	10	Int0

JP12: COM3 RS232 +5V / +12V Power Setting

Pins [1-2] shorted = Standard COM Port; [5-6] = +12V; [3-4] = +5V

Pin	Signal Name	JP4	Signal Name	Pin
1	(Default)		(Default)	2
3	12V			RI

5	5V		RI	6
---	----	--	----	---

3.2 Connectors

Below are the functions and values of the connectors found on the Flex-845E main board:

CN1: Connector

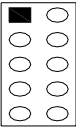

Signal Name	Pin	Pin	Signal Name
Ground	1	2	PW-ON
Ground	3	4	Reset_SW
IDE_LED-	5	6	IDE_LED+
Power_LED+	7	8	Power_LED-
LAN_LED-	9	10	LAN_LED+

CN2: 26-pin Slim TYPE Floppy Connector, supports 1 x Slim Floppy Disk Drive (FDD).



Signal Name	Pin #	Pin #	Signal Name
VCC	1	2	INDEX
VCC	3	4	DRV_SEL
VCC	5	6	DSK_CH
NC	7	8	NC
NC	9	10	MOTOR
DINST	11	12	DIR
NC	13	14	STEP
GND	15	16	WDATA
GND	17	18	WGATE
GND	19	20	TRACK
NC	21	22	WPROT
GND	23	24	RDATA
GND	25	26	SIDE

CN3: LVDS PANEL OUTPUT

Pin1	Pin2	Pin3	Pin4	Pin5	Pin6	Pin7	Pin8	Pin9	Pin10
VDD	A4M	A4P	VDD	GND	GND	A5M	GND	A5P	A0M
Pin11	Pin12	Pin13	Pin14	Pin15	Pin16	Pin17	Pin18	Pin19	Pin20
GND	A0P	A6M	GND	A6P	A1M	GND	A1P	Clk2M	GND
Pin21	Pin22	Pin23	Pin24	Pin25	Pin26	Pin27	Pin28	Pin29	Pin30
Clk2P	A2M	GND	A2P	A7M	GND	A7P	Clk1M	GND	Clk1P
Pin31	Pin32	Pin33	Pin34	Pin35	Pin36	Pin37	Pin38	Pin39	Pin40
NC	GND	NC	A3M	NC	A3P	NC	GND	NC	NC

CN4: Inverter Power



Pin	Signal Name
1	Ground

2	Ground
3	Enable
4	+12V

CN5: USB Connectors

The following table shows the pin outs of the USB pin headers connectors. Overall, the one pin header supports four USB ports (USB 2.0 compliant).

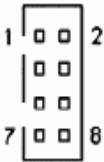

Signal Name	Pin	Pin	Signal Name
Vcc	1	2	Vcc
USB5-	3	4	USB6-
USB5+	5	6	USB6+
Ground	7	8	Ground

CN6: CD-In Audio Connector



Pin	Signal Name
1	CD Audio R
2	Ground
3	Ground
4	CD Audio L

CN7: USB Connectors

The following table shows the pin outs of the USB pin headers connectors. Overall, the one pin header supports four USB ports (USB 2.0 compliant).



Signal Name	Pin	Pin	Signal Name
Vcc	1	2	Vcc

USB3-	3	4	USB4-
USB3+	5	6	USB4+
Ground	7	8	Ground

CN8: USB Connectors

The following table shows the pin outs of the USB pin headers connectors. Overall, the one pin header support four USB ports (USB 2.0 compliant).

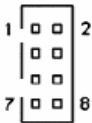

Signal Name	Pin	Pin	Signal Name
Vcc	1	2	Vcc
USB1-	3	4	USB2-
USB1+	5	6	USB2+
Ground	7	8	Ground

J1: Internal Speaker Connector



Pin	Signal Name
1	SPK_LN
2	SPK_LO
3	SPK_RN
4	SPK_RO

AU1: Line In, Line Out, & Microphone Connector



Port	Function
1	Line In
2	Line Out
3	Microphone

CN6: External PS/2 Keyboard /Mouse Connector



Signal Name	Pin	Pin	Signal Name
KB-DATA	1	2	M-DATA
KB-CLK	3	4	M-CLK
GND	5	6	GND
VCC	7	8	Vcc

COM3:



Signal Name	Pin	Pin	Signal Name
DCD, Data carrier detect	1	2	DSR, Data set ready
RXD, Receive data	3	4	RTS, Request to send
TXD, Transmit data	5	6	CTS, Clear to send
DTR, Data terminal ready	7	8	RI, Ring indicator
Ground	9	10	No Connect

COM5:



Signal Name	Pin	Pin	Signal Name
DCD, Data carrier detect	1	2	DSR, Data set ready
RXD, Receive data	3	4	RTS, Request to send
TXD, Transmit data	5	6	CTS, Clear to send
DTR, Data terminal ready	7	8	RI, Ring indicator
Ground	9	10	No Connect

COM6 (Optional)



Signal Name	Pin	Pin	Signal Name
DCD, Data carrier detect	1	2	DSR, Data set ready

RXD, Receive data	3	4	RTS, Request to send
TXD, Transmit data	5	6	CTS, Clear to send
DTR, Data terminal ready	7	8	RI, Ring indicator
Ground	9	10	No Connect

FAN1, FAN2: CPU Fan Power Connector - 3-pin header for CPU fans. The fan must be a 12V (500mA) fan.

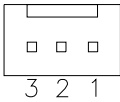

Pin	Signal Name
1	Ground
2	+12V
3	Rotation detection

MODEM:

Pin	Signal Name	MODEM	Signal Name	Pin
1	Ground	<p>A diagram of a 16-pin D-sub connector. The pins are arranged in two rows of eight. Pin 1 is a solid black square, and pins 2 through 16 are circles. The pins are numbered 1 through 16 from top to bottom.</p>	Ground	2
3	DCD, Data carrier detect		RXD, Receive data	4
5	TXD, Transmit data		DTR, Data terminal ready	6
7	DSR, Data set ready		RTS, Request to send	8
9	+5V		NC	10
11	CTS, Clear to send		RI, Ring indicator	12
13	NC		MODEM SP	14
15	MODEM RESET		Ground	16

IO1 :

Pin	Signal	Pin	Signal
1	Gnd	2	DCD0
3	DSR0	4	RXD0
5	RTS0	6	TXD0
7	CTS0	8	DTR0
9	RI0	10	Gnd
11	STBX	12	AFDX
13	PPD0X	14	-ERR
15	PPD1X	16	PINITX
17	PPD2X	18	SLINX
19	PPD3X	20	PPD4X
21	PPD5X	22	PPD6X
23	PPD7X	24	Gnd
25	SLCT	26	PE
27	BUSY	28	-ACK
29	Gnd	30	Gnd
31	DOUT0	32	DINT0
33	Gnd	34	GND

IO2 :

Pin	Signal	Pin	Signal
1	Gnd	2	NDCD1
3	DSR1	4	NSIN1
5	RTS1	6	NSOUT1
7	CTS1	8	NDTR1
9	RI1	10	Gnd
11	DCD3	12	DSR3
13	RXD3	14	RTS3
15	TXD3	16	CTS3
17	DTR3	18	RI3
19	Gnd	20	C-RED
21	Gnd	22	C-GREEN
23	Gnd	24	C-BLUE
25	Gnd	26	5VDDCDA
27	C-VSYNC	28	C-HSYNC
29	5VDDCCL	30	CRT5V_F
31	Gnd	32	TXD0+
33	TXD0-	34	RXIN0+
35	RXIN0-	36	Gnd
37	VCC3DUAL	38	Gnd
39	LED10	40	LED00

IDE1: Primary IDE Connector

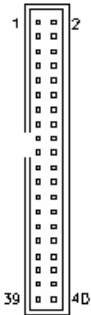

Signal Name	Pin	Pin	Signal Name
Reset IDE	1	2	Ground
Host data 7	3	4	Host data 8
Host data 6	5	6	Host data 9
Host data 5	7	8	Host data 10
Host data 4	9	10	Host data 11
Host data 3	11	12	Host data 12
Host data 2	13	14	Host data 13
Host data 1	15	16	Host data 14
Host data 0	17	18	Host data 15
Ground	19	20	Protect pin
DRQ0	21	22	Ground
Host IOW	23	24	Ground
Host IOR	25	26	Ground
IOCHRDY	27	28	Host ALE
DACK0	29	30	Ground
IRQ14	31	32	No connect
Address 1	33	34	No connect
Address 0	35	36	Address 2
Chip select 0	37	38	Chip select 1
Activity	39	40	Ground

IDE2 : Secondary IDE Connector

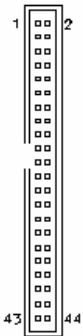

Signal Name	Pin	Pin	Signal Name
Reset IDE	1	2	Ground
Host data 7	3	4	Host data 8
Host data 6	5	6	Host data 9
Host data 5	7	8	Host data 10
Host data 4	9	10	Host data 11
Host data 3	11	12	Host data 12
Host data 2	13	14	Host data 13
Host data 1	15	16	Host data 14
Host data 0	17	18	Host data 15
Ground	19	20	Key
DRQ0	21	22	Ground
Host IOW	23	24	Ground
Host IOR	25	26	Ground
IOCHRDY	27	28	Host ALE
DACK0	29	30	Ground
IRQ14	31	32	No connect
Address 1	33	34	No connect
Address 0	35	36	Address 2
Chip select 0	37	38	Chip select 1
Activity	39	40	Ground
Vcc	41	42	Vcc
Ground	43	44	N.C.

4. INPUT/OUTPUT CONNECTIONS

4.1 Flash Memory Card Reader / Writer

The Q-POS may include an optional built-in flash memory card reader/writer on the front panel that supports SD, MMC, CF, SM, MS and MS Micro flash memory cards. Memory cards provide nonvolatile storage solutions, which do not require batteries to retain data indefinitely. With easy access from the front panel, users can quickly insert their memory cards to transfer data such as

NOTE:

1. Do not remove flash memory cards during operation.
2. Do not format flash memory cards using this reader. The Memory card should be formatted by the digital camera or Audio player to assure the compatibility of the format.

4.2 Hybrid Swipe Card Reader

The Q-POS may include a mounted hybrid card reader that is built to handle both synchronous and asynchronous (T=0, T=1) types of cards in accordance with the ISO 7816-1, 2 and 3 standards. For magnetic swipe cards, the hybrid card reader can read single, dual, or triple track data in accordance with ISO 7811 standards. Magnetic cards encoded to ISO/ANSI standards can be swiped bi-directionally. The software application can be updated to handle new card formats or user protocol changes after installation.

Smart Card Interface:

- Automatic recognize and access 5V/3V/1.8V (Class A, B, C) smart card
- Short-circuit protection
- Reads from and Writes to all ISO7816-1/2/3

microprocessor cards, T=0 and T=1

- Wide range communication baud rate up to 11.625 clock pulses (D=32/F=372)
- Supports S-block functions: WTX, Abort, IFS

Magnetic Card Interface:

- Magnetic Head Life:500,000 passes
- Card Types:ISO, ANSI, AAMVA, CA DMV (300~4000Oe)
- Read Speed Range:4 ~ 55 ips

4.3 USB 2.0 Ports

Built into the front panel is an easy access 5V USB 2.0 port for connecting devices such as a USB hub, USB input devices and more. In the rear IO panel of the Q-POS are two powered USB 2.0 480Mb/s ports for peripheral connectivity. One 24V powered USB 2.0 port is useful for connecting external thermal printers, customer display LCDs, projectors, and other office machines. The other powered USB One 12V powered USB 2.0 port is useful for connecting external CD/DVD/Combo drives, external HDD enclosures, LCD monitors, scanners, gaming equipment and much more. Some USB devices require a driver to be installed prior to connecting the cable. If the driver is already installed, simply plug-in the USB device cable to the USB port will make a connection.

Please Note: If Windows XP is installed, XP Service Pack 1 or higher is required for Microsoft's latest USB 2.0 device support.

4.4 Serial / COM Ports

The Q-POS features six serial COM ports used to support internal components. Two are located inside the system for the touch screen controller and an additional connection, and four are in the rear IO panel, ready to connect to a wide range of serial devices. COM 1,

COM 2, COM 4 & COM 5 are RS-232 enabled ports accessible from the rear IO panel. COM 3 is reserved internally for the touch screen controller and COM 6 is onboard. COM ports 1, 2 and 4 include +5V/+12V power capabilities on pin 9, providing easy accommodation to a broad range of serial devices. Default settings are set to RS-232 and 5V. Should there be a need to alter a COM Port RS or voltage setting, contact the Q-POS supplier for further instructions.

4.5 Ethernet 100/10 Base-T LAN (RJ-45)

The Q-POS provides one 100/10 Base-T NE2000 compatible Ethernet (RJ-45) interface. To establish a connection, plug in one end of CAT4/5/6 cable from a 100/10 Base-T switching hub to the RJ-45 port.

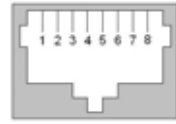

RJ-45 Connector Pin Assignment

Pin	Assignment
1	Tx+ (data transmission positive)
2	Tx- (data transmission negative)
3	Rx+ (data reception positive)
6	Rx- (data reception negative)
7, 8	Not in use

4.6 VGA Interface

The Q-POS has a 15-pin analog RGB connector located in the rear IO panel. It can support its own LCD display plus an expansion CRT or analog monitor at the same time. However, because the LCD panel used in the Q-POS uses a resolution of 1024 x 768, connecting a CRT or analog monitor simultaneously, the monitor's VGA resolution has to be set to 1024 x 768 also. Connecting to an analog monitor is easy by plugging in the VGA D-SUB 15-pin connector to the RGB interface.

Some software applications operate only in 800x600 resolution. If

such software is installed on the Q-POS, only part of the screen may show on the LCD display. If the application has to run in full screen, you need to update the system VGA drivers with an auto expansion utility. However, due to resolution limitation, text mode displays might look slightly distorted.

4.7 PS/2 Keyboard Interface

The Q-POS provides a standard PS/2 keyboard connector located in the rear IO panel. If the user would like to use AT keyboard, then an adapter to connect the PS/2 KB to AT KB is needed. When the Q-POS is shut off, carefully plug-in the PS/2 keyboard connector to the keyboard PS/2 port

4.8 PS/2 Mouse Interface

The Q-POS has one PS/2 mouse connector located in the rear IO panel. When the Q-POS is shut off, carefully plug-in the PS/2 mouse connector to the mouse PS/2 port.

4.9 LPT Printer Port

The Q-POS is equipped with a standard ECP/SPP selectable D-SUB 25pin printer port in the rear IO panel. Optional settings for the LPT port are available through the system BIOS.

4.10 Audio Interface (Line/SPK-Out)

The audio interface is located within the system panel, directly connected to the main board. If an internal speaker, or microphone is to be installed, refer to figure 2-6 and locate the PC99 color coded audio ports to the left of the CPU fan. Please note that the audio driver must be installed first before audio devices will function.

4.11 RJ-11 Cash Drawer Port

The Q-POS has one RJ-11 Cash Drawer connector located in the rear pedestal panel. When the Q-POS is shut off, carefully plug-in the Cash Drawer cable connector to the Cash Drawer RJ-11 port.

Cash Drawer RJ-11 Pin Assignments:

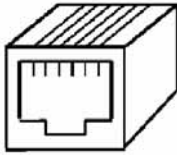

1 6

Pin	Assignment
1	Ground
2	CASH_1 (Programmable)
3	Digital IN
4	+12V/+24V
5	NC
6	Ground

4.12 Customer Display Pole (Optional)

The Pole Customer Display is an artistically designed POS system peripheral device. It is for use with POS system to display the purchased prices and the amount of change to customers. Also it is capable to display advertising messages. With its RS-232 interface the Customer Display Pole mounts on the rear base panel and connects with one of the available COM ports for operation.

Since the Customer Display Pole requires a +12VDC RS-232 connection, set the corresponding I/O COM port voltage output on pin-9 to +12V. Please refer to the manufacture's reference guide for installation.



5. AWARD BIOS SETUP

This chapter describes how to set up the BIOS configuration.

5.1 Award BIOS

The Award BIOS setup program allows users to modify basic system configuration settings such as the current date and time, or the type of peripheral devices attached to the computer.

Under the following conditions, the CMOS settings may need to be modified:

1. The system is being setup for the first time
2. Hardware devices attached to the system have changed
3. The CMOS memory has lost power and the configuration information has been erased.

The BIOS setup program is stored in ROM, which can be accessed by pressing key on the keyboard immediately when the system is powered on.

In order to retain BIOS setup information while the system power is turned off, the system setup information is stored in battery-powered CMOS RAM. The battery ensures the settings will not be erased when the computer is turned off or reset. When the computer is powered on again, the system will read the settings stored in the CMOS RAM and compare them to the equipment check conducted during the power on self-test (POST). If any error or mismatch occurs, an error message will display on the screen and the computer will prompt the setup program to run again.

5.2 Control Key Definition

Up arrow	Move to previous item
Down arrow	Move to next item
Left arrow	Move to the item in the left position
Right arrow	Move to the item in the right position
ESC key	Main Menu - Quit without saving changes Status Page - Setup Menu and Option Page Setup Menu - Exit current page and return to Main Menu
PgUp key	Increase the numeric value or make changes
PgDn key	Decrease the numeric value or make changes
F1 key	General help, only for Status Page Setup Menu and Option Page Setup Menu
F2 key	Item Help
F3 key	Reserved
F4 key	Reserved
F5 key	Restore the previous CMOS value from CMOS, only for Option Page Setup Menu
F6 key	Load the Fail safe default CMOS value from BIOS default table, only for Option Page Setup Menu
F7 key	Load the Optimize default
F8 key	Reserved
F9 key	Reserved
F10 key	Save all the CMOS changes, only in Main Menu

5.3 Getting Help

The on-line description of the highlighted setup function is displayed at the bottom of the screen.

Press <F1> to pop up a small help window that describes the appropriate keys to use and the possible selections for the highlighted item. To exit the Help Window, press <ESC>.

5.4 Award BIOS Setup

5.4.1 Award BIOS Setup Main Menu

Power on the computer and press immediately to run the AWARD BIOS setup. The setup main menu will appear:



Use the arrow keys to move among the items and press <Enter> to enter the sub-menu.

STANDARD CMOS SETUP: This setup page includes all the items in standard compatible BIOS.

ADVANCED BIOS FEATURES: This setup page includes all the items of Award special enhanced features.

ADVANCED CHIPSET FEATURES: This setup page includes all the items of chipset special features.

INTEGRATED PERIPHERALS: This setup page includes all onboard peripherals.

POWER MANAGEMENT SETUP: This setup page includes all the items of Green function features.

PnP/PCI CONFIGURATION: This setup page includes all the configurations of PCI & PnP ISA resources.

PC HEALTH STATUS: This setup page auto detects the temperature, voltage and fan speed.

FREQUENCY/VOLTAGE CONTROL: This setup page includes the CPU/SDRAM/PCI frequency setting

LOAD FAIL-SAFE DEFAULTS: BIOS Defaults indicates the most appropriate value of the system parameters that the system would be in safe configuration.

LOAD OPTIMIZED DEFAULTS: Setup Defaults indicates the value of the system parameters that the system would be in the best performance configuration.

SET SUPERVISOR PASSWORD: Change, set, or disable the master supervisor's password. It allows you to limit access to the system and Setup, or just to Setup.

SET USER PASSWORD: Change, set, or disable user's passwords. It allows you to limit access to the system and Setup, or just to Setup.

SAVE & EXIT SETUP: Save CMOS value settings to CMOS and exit setup.

EXIT WITHOUT SAVING: Abandon all CMOS value changes and exit setup.

5.4.2 Standard CMOS Features

If the **STANDARD CMOS FEATURE** is selected from the main menu, the screen below will appear. This menu allows the users to configure the system components such as date, time, hard disk drive, floppy disk drive and display type. The system BIOS will automatically detect the memory size; therefore no setting is needed.

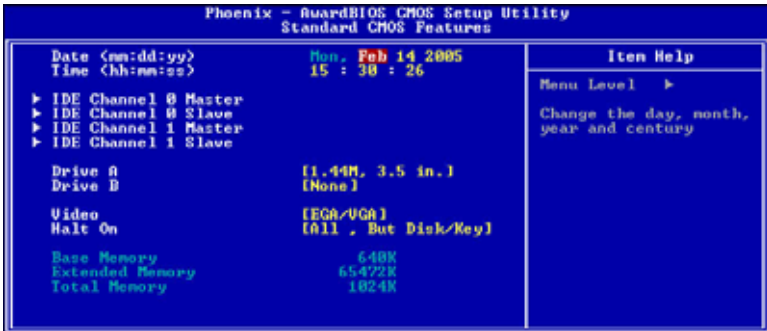

Date

The date format is <Day>, <Month> <Date> <Year>.

Day	The day, from Sun to Sat, determined by the BIOS and is only for display
Month	The month, Jan. through Dec.
Date	The date, from 1 to 31
Year	The year, from 1994 through 2079

Time

The times format in <hour> <minute> <second>. The time is calculated base on the 24-hour military-time clock. For example, 1 p.m. is 13:00:00.

IDE Primary HDDs / Secondary HDDs

The categories identify the types of hard disk from drive C to F that have been installed in the computer. There are two types: auto type, and user definable type. User type is user-definable; Auto type will

automatically detect HDD type(s).

Note that the specifications of your drive must match with the drive table. The hard disk will not work properly if you enter improper information for this category.

If you select User Type, the following items need to be entered. Enter the information directly from the keyboard and press <Enter>. Such information is provided in the documentation from your hard disk vendor or the system manufacturer.

CYLS.	Number of cylinders
HEADS	Number of heads
PRECOMP	Write precomp
LANDZONE	Landing zone
SECTORS	Number of sectors

If a hard disk is not installed, select NONE and press <Enter>.

Drive A type / Drive B type

This category identifies the types of floppy disk drive A or drive B that have been installed in the computer.

None	No floppy drive installed
360K, 5.25"	5.25 inch PC-type standard drive; 360K byte
1.2M, 5.25"	5.25 inch AT-type high-density drive; 1.2M byte (3.5 inch when 3 Mode is Enabled).
720K, 3.5"	3.5 inch double-sided drive; 720K byte
1.44M, 3.5"	3.5 inch double-sided drive; 1.44M byte
2.88M, 3.5"	3.5 inch double-sided drive; 2.88M byte

Video

The category selects the default video device

Options: EGA/VGA/CGA40/CGA80/Mono

Halt on

The category determines whether the computer will stop if an error is

detected during power up.

NO Errors	The system boot will not stop for any error that may be detected
All Errors	Whenever the BIOS detects a non-fatal error the system will be stopped and you will be prompted
All, But Keyboard	The system boot will not stop for a keyboard error; but will stop for all other errors
All, But Diskette	The system boot will not stop for a disk error; but will stop for all other errors
All, But Disk/Key	The system boot will not stop for a keyboard or disk error; but will stop for all other errors

5.4.3 Advanced BIOS Features

If the **ADVANCED BIOS FEATURES** option is selected from the main menu, the screen below will appear. The following sample screen consists of the default values for the Q-POS.

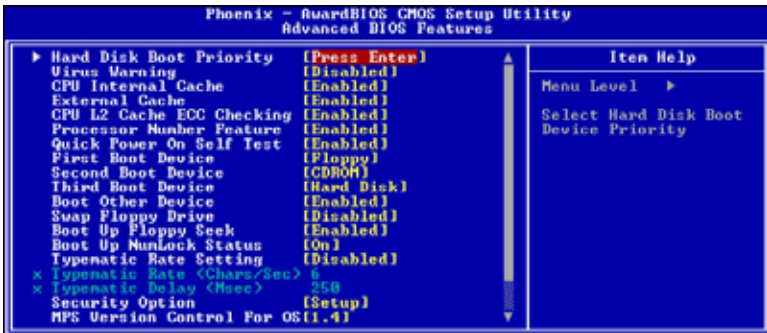

5.4.4 Advanced Chipset Features

If the **ADVANCED CHIPSET FEATURES** option is selected from the main menu, the screen below will appear. The following sample screen consists of the default values for the Q-POS.

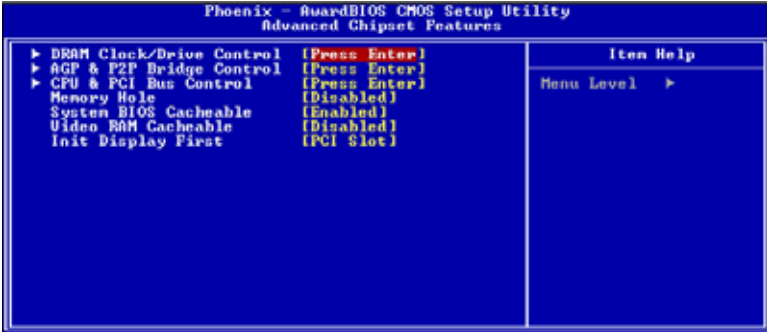

5.4.5 Integrated Peripherals

If the **INTEGRATED PERIPHERALS** option is selected from the main menu, the screen below will appear. The following sample screen consists of the default values for the Q-POS.

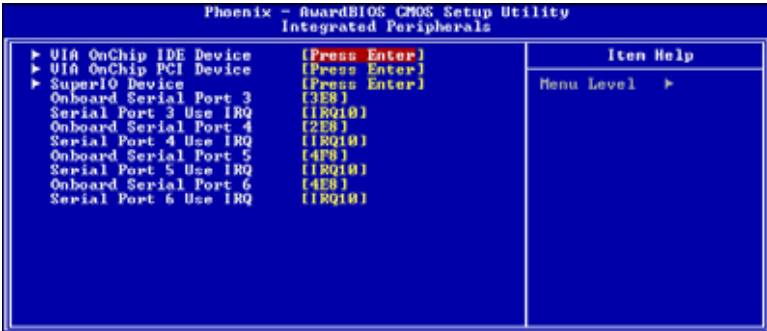

5.4.6 Power Management Setup

If the **POWER MANAGEMENT SETUP** option is selected from the main menu, the screen below will appear. The following sample screen consists of the default values for the Q-POS.

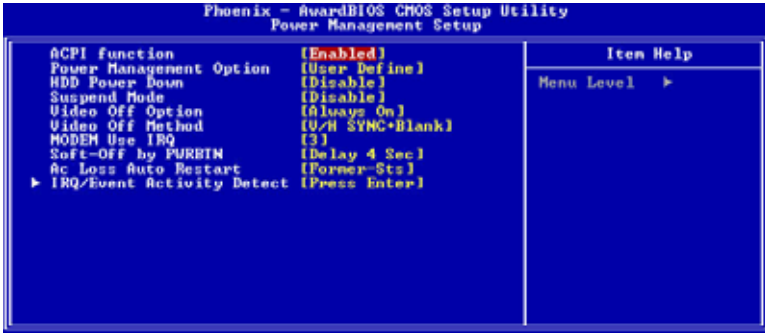

5.4.7 PnP/PCI Configuration

If the **PNP/PCI CONFIGURATION** option is selected, the following sample screen displays default values for the Q-POS.

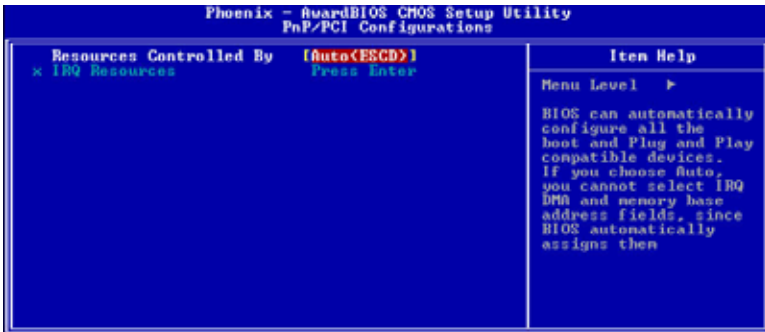

5.4.8 PC Health Status

PC HEALTH STATUS auto detects the system's temperature, voltage, and fan speed.



5.4.9 Frequency Voltage Control

This setup page is for the CPU, SDRAM and PCI frequency setting.

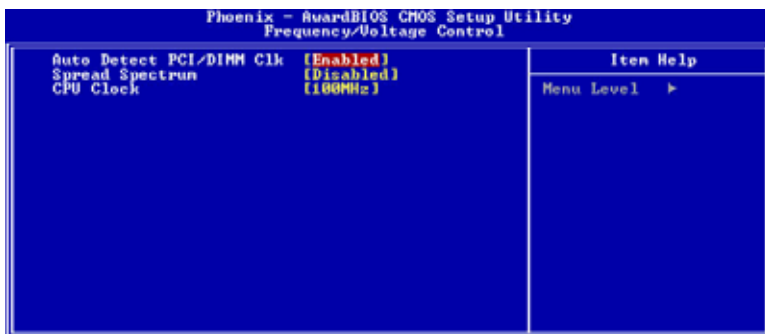

6. SOFTWARE & DRIVER INSTALLATION

The chapter provides background information and instructions to properly install the Q-POS software drivers using Windows 98/Me/2000/XP operating systems. The included Utility CD includes Windows drivers for the internal 56k Modem, Audio-Sound driver, Ethernet Lan Driver, Touch Screen driver, USB driver (Win XP requires SP1 or later), VGA Display drivers and Wireless Lan. Also included separately may be MMR/VFD software drivers. Recent releases of operating systems include setup programs that load automatically and guide you through each driver installation.

6.1 Audio

To install the internal SoundMAX audio sound controller, locate and run the [Setup.exe] program found on the Q-POS Utility CD in the "AUDIO" sub-directory.

6.2 Hybrid Swipe Card Reader

If a hybrid swipe card reader is mounted to the Q-POS, the two green LED show shine when the Q-POS is powered on. To install the software utility, locate and run the [install.exe] program found on the Q-POS Utility CD in the "HybridCardReader" sub-directory and install the utility for "VK52XX". A hardware installation notice may indicate that the SYN STD200 USB Smart Card Reader Driver has not passed Windows Logo Testing, but the product has been fully tested and to complete the installation of the driver, click "Continue Anyway." After the software is installed, click yes to restart the Q-POS.

After the system is restarted, open the Hybrid Reader Utility to test

and configure the reader.

1. In the selection menu, the VK52XX model should appear for selection.

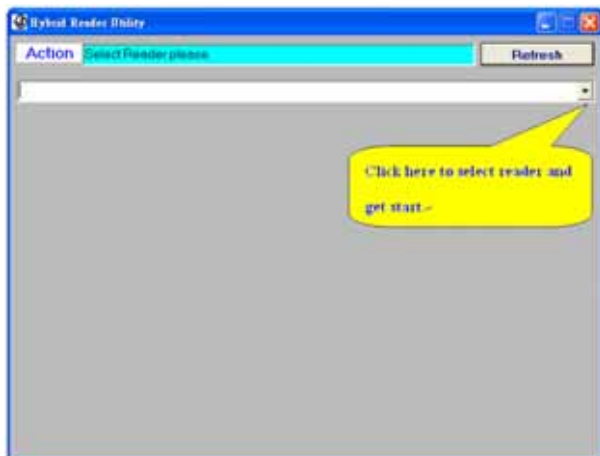

2. When the two green LEDs are lit and the following screen is showing, the system is ready for operation. Swipe a card with the stripe facing away from the Q-POS either upwards or downwards.

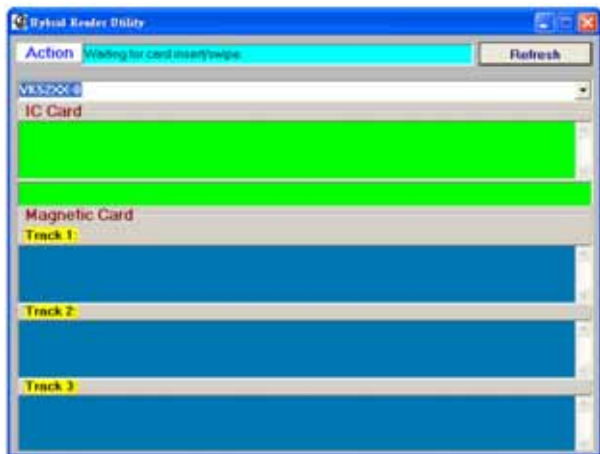

- When a card is swiped a grouping of data numeric or alphanumeric characters will display in appropriate screen.

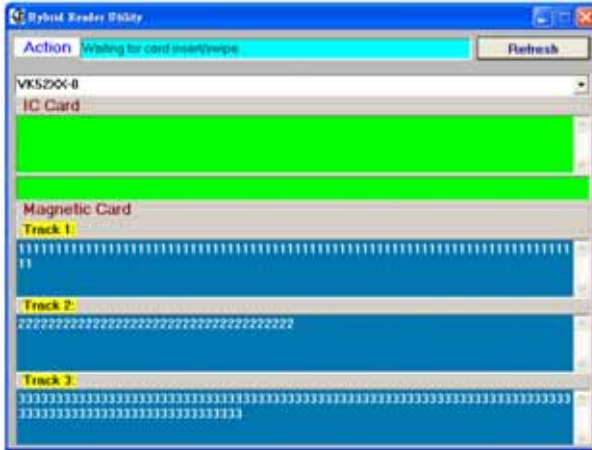

- If the reader identifies a bad reading or no data in any of the tracks, a character 'F' (bad reading) or 'N' (no data) will replace a string characters as above description. The following example shows track 2 is bad and tracks 1 and 3 are good.



6.3 Ethernet LAN

To install the internal Ethernet LAN controller in Windows operating systems, locate and run the [Setup.exe] program found on the Q-POS Utility CD in the “LAN_RTL8101L” sub-directory.

6.4 Touch Screen

First, it is highly recommended that Chapter 6 – Touch Screen is read first for information about the embedded Elo Touch Screen and controller.

To install the drivers for the Touch Screen controller, locate and run the [EloSetup.exe] install program found on the Q-POS Utility CD in the “Touch\Elo WinXP Serial Driver 4.0” sub-directory. There are additional operating systems supported by this controller, by please note that non-Windows operating system installations may not be supported.

6.5 USB 2.0

Please note, if Windows XP is installed, XP Service Pack 1 or higher is required for Microsoft's latest USB 2.0 device support. To install the USB 2.0 host controller in Windows operating systems, locate and run the [usb2.0.exe] program found on the Q-POS Utility CD in the “Usb20” sub-directory.

6.6 VGA Video

To install the VGA Video software drivers, locate and run the [setup.exe] program found on the Q-POS Utility CD in the “VGA driver” sub-directory corresponding with your OS. After rebooting, the screen is best displayed at resolution of 1024 x 768 pixels. To change the resolution, click the right mouse button on the desktop, and select **Properties**. Go to the **Settings** page, and change the Screen

resolution from 800 by 600 pixels, to 1024 by 768 pixels. The color quality should be set to 32 bit for maximum quality.

6.7 Wireless LAN

The Q-POS may come ready-equipped for the optional WLAN 802.11g adapter and antenna, which complies with IEEE 802.11g, and supports speeds up to 54/48/36/24/18/12/9/6 Mbps. The wireless 11g Network Adapter provides data transmission rates up to 54Mbps, five times faster than common 802.11b devices.



Since 802.11g products share the same 2.4GHz radio band with all other 802.11b devices, the WLAN 11g Network Adapter is backward compatible with all the current 802.11b devices. Security wise, it employs Wired Equivalent Privacy (WEP) with 64/128-bit encryption; it also includes AES algorithm for enhanced data protection during wireless transmission.

To install the WLAN adapter in Windows operating systems, locate and run the [setup.exe] program found on the Q-POS Utility CD in the "WLAN" sub-directory.

7. TOUCH SCREEN (ELO)

7.1 Introduction

The Q-POS may be installed with an Elo 5-wire resistive touch screen . The touch screen panel turns the flat-panel display into a dynamic graphical user interface (GUI) and data entry device.

The touch screen represents a replacement to needing a keyboard and mouse to interface with the computer. People associate actions or functions with visual images better than a combination of keystrokes or button clicks. Using a touch panel is more entertaining for the operator and actually requires less brain activity than traditional control devices.

Elo's touch screens are the preferred solution for applications requiring unsurpassed performance, reliability, and clarity. Their durable, pure-glass construction delivers the ultimate in image clarity and light transmission, preserves color purity, and works even if scratched. With their stable, drift-free operation, the IntelliTouch touch screens guarantee a touch response that is on target. The IntelliTouch touch screens are the ideal solution for Q-POSs, ticketing machines, gaming machines, light industrial, and office automation.

7.2 Construction

The built-in Elo five-wire resistive touch screen uses a glass panel with a uniform resistive coating. A thick polyester coversheet is tightly suspended over the top of the glass, separated by small, transparent insulating dots. The coversheet has a hard, durable coating on the outer side and a conductive coating on the inner side. When the screen is touched, the conductive coating makes electrical contact with the coating on the glass. The voltages produced are the analog representation

of the position touched. The controller digitizes these voltages and transmits them to the computer for processing.

Elo five-wire technology utilizes the bottom substrate for both X and Y-axis measurements. The flexible coversheet acts only as a voltage-measuring probe. This means the touch screen will continue working properly even with non-uniformity in the cover sheet's conductive coating. The result is an accurate, durable and reliable touch screen that offers drift free operation. Elo screens are sealed against contamination and moisture. The coversheet is sealed to the glass substrate with an industrial grade caulk. This prevents fluid from gaining entry between the coversheet and glass. Also, Elo screens are not air vented, thereby preventing fluid ingress through an air vent.

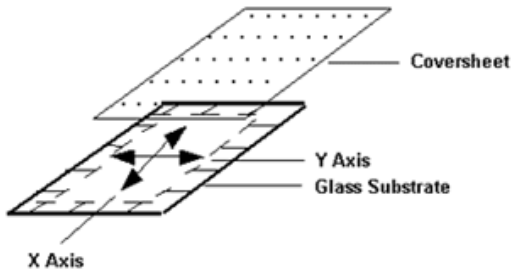

7.3 Features

- Excellent image clarity with high light transmission
- Extremely fast and sensitive
- Excellent durability, resistant to deep scratches and abrasion
- Activated by a finger, gloved-hand or soft stylus
- Inherently stable, drift-free operation
- Dirt and splash sealing capability

7.4 Specifications

Input Method	Finger or gloved hand (cloth, leather, or rubber) activation
Positional Accuracy	Standard deviation of error is less than 0.080 in. (2 mm)
Controller	Serial (RS232)
Temperature	Operating: -20°C to 50°C Storage: -40°C to 71°C
Relative Humidity	Operating: 40°C at 90% RH, non-condensing
Altitude	Operating: 10,000 ft (3,048 m) Storage/transport: 50,000 ft (15,240 m)
Chemical Resistance	The touch active area of the touch screen is resistant to chemicals that do not affect glass, such as: acetone, toluene, methyl ethyl ketone, isopropyl alcohol, methyl alcohol, ethyl acetate, ammonia-based glass cleaners, gasoline, kerosene, vinegar
Agency Approvals	UL, cUL, TUV, CE, FCC Class A
Seal-ability	Can be sealed to meet NEMA 3/3R/5/12/12K/13, IP64 standards
Surface Durability	Surface durability is that of glass, Mohs' hardness rating of 7
Expected Life	No known wear-out mechanism, as there are no layers, coatings, or moving parts.

7.5 Elo Touch Screen Software Driver

Elo touch screens configured with the Q-POS will require software drivers to be installed to enable the touch screen functionality. The driver software scales the absolute coordinates received from the touch screen controller into translated screen coordinates, using the calibration points obtained with the video alignment program included

with the driver software. The driver also performs other operations as directed by the application.

Elo provides driver programs for the DOS, Windows 3.1, Windows CE, Windows 95/98, Windows NT, Windows 2000, OS/2, and Macintosh operating systems. Additional drivers are also available. Additional operating systems are supported through outside sources. Refer to the Elo web site, www.elotouch.com, for details. If you cannot use an available driver, Elo can supply all the touch screen related information you will need to write your own driver for any type of system, including UNIX workstations, real-time systems, and embedded systems.

7.6 Touch Screen Care and Cleaning

Only use soft non-abrasive lint free wipes with Isopropyl 99% to clean dirt or stains found on the touch panel. Always dampen the wipes and then clean the touch panel. Chemical liquids with strong acidic base will damage the touch screen and void the warranty.

7.7 Troubleshooting

If you experience operational difficulties with the touch screen system either during or after installation, the following sections will help you determine the source of the problem.

The first step in troubleshooting a touch screen system is to determine whether the problem is related to the display, software, or hardware:

- Do not confuse display problems with touch screen problems, as the two issues are unrelated.
- Software problems are determined by a basic hardware functionality test. If the hardware transmits touch coordinates

correctly, then the problem is probably with the driver or application software.

- Hardware problems may be caused by the touch screen, controller, cabling, power supply, or by the integration of the touch screen components in the display. This appendix describes techniques for isolating the problem, including power-on diagnostics, status LED verification, and component swapping.

7.7.1 Display Problems

If you are experiencing display problems (such as no video, no horizontal or vertical synchronization, raster non-linearities, etc.), remember that the video function of the display and the Elo touch screen installed on the display are separate systems. Therefore, problems with the display should be treated as display problems, not touch screen problems. Diagnostic procedures and possible corrections for display problems should be performed.

7.7.2 Software Troubleshooting

Before beginning software troubleshooting, verify that the touch screen hardware is working by running the COMDUMP program for serial controllers. If the touch screen is operating, then the problem may be with the driver software, the application software, or a conflict with other hardware or software. (The problem may also be due to incorrect touch screen video alignment).

The general technique for troubleshooting software problems is to identify at what layer of software and associated hardware the problem exists. For example, if you have a Windows application, there are several layers of software and drivers. The problem could be with your application, Windows, MonitorMouse for Windows, MonitorMouse for DOS, the ELODEV driver, a conflict with another device, or the touch screen hardware. The best approach to software troubleshooting is to remove the layers of software one by one,

testing each layer until the problem is isolated. Also try removing other hardware and software that may be conflicting with the touch screen hardware and driver software.

7.7.3 Video Alignment Problems

If the touch screen is responding and the data is linear, but a touch does not activate the appropriate zone in the application, try video alignment. Use ELOCALIB under DOS or the Touch screen Control Panel with all versions of MonitorMouse. Improper video alignment may be indicated when the cursor does not move at the same pace as a sliding finger, or when it moves in the opposite direction. The cursor should always move in the same axis as your finger.

If you have a DOS application, erase any ELOGRAPH.CAL files and complete video alignment in the video mode used by your application. For example, you may have a VGA monitor with your application running in text mode, so complete video alignment in text mode rather than graphics mode.

7.7.4 Hardware Troubleshooting

Troubleshooting the touch screen hardware may require analysis of the touch screen, controller, cables, power supply, and the integration process. The best place to start is with the controller. Use the controller power-on diagnostics that are displayed when the Elo driver software is loaded to check for specific faults. Also, check whether the controller is transmitting any touch data. Use the COMDUMP program for serial controllers. The 2310B operates at 9600 baud, 8 data bits, 1 stop bit, and no parity.

No touch data: When no touch data is reported, the problem may be the touch screen, controller, or cabling. If the controller power-on diagnostics or diagnostic LED's do not identify the problem, substitute individual system components if they are available.