

BIXOLON[®]
SAMSUNG mini printers

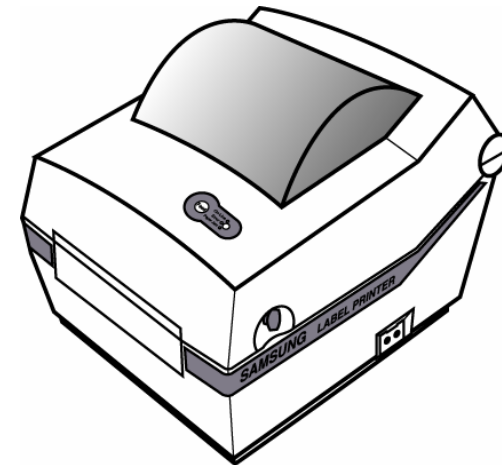

USER'S MANUAL
SRP-770II

LABEL PRINTER









BIXOLON[®]
SAMSUNG mini printers

KA04-00019E
Rev. 1.02

www.samsungminiprinters.com

Safety Precautions

In using the present appliance, please keep the following safety regulations in order to prevent any hazard or material damage.

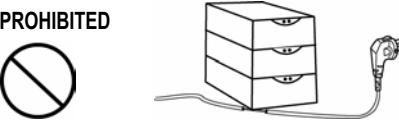
 WARNING Violating following instructions can cause serious injury or death.	
<p>Do not plug several products in one multi-outlet.</p> <ul style="list-style-type: none"> This can provoke over-heating and a fire. If the plug is wet or dirty, dry or wipe it before usage. If the plug does not fit perfectly with the outlet, do not plug in. Be sure to use only standardized multi-outlets. 	<p>You must use only the supplied adapter.</p> <ul style="list-style-type: none"> It is dangerous to use other adapters.
<p>PROHIBITED</p> 	<p>ONLY SUPPLIED ADAPTER</p> 
<p>Do not pull the cable to unplug.</p> <ul style="list-style-type: none"> This can damage the cable, which is the origin of a fire or a breakdown of the printer. 	<p>Keep the plastic bag out of children's reach.</p> <ul style="list-style-type: none"> If not, a child may put the bag on his head.
<p>PROHIBITED</p> 	<p>PROHIBITED</p> 
<p>Do not plug in or unplug with your hands wet.</p> <ul style="list-style-type: none"> You can be electrocuted. 	<p>If you observe a strange smoke, odor or noise from the printer, unplug it before taking following measures.</p> <ul style="list-style-type: none"> Switch off the printer and unplug the set from the mains. After the disappearance of the smoke, call your dealer to repair it.
<p>PROHIBITED</p> 	<p>TO UNPLUG</p> 
<p>Do not bend the cable by force or leave it under any heavy object.</p> <ul style="list-style-type: none"> A damaged cable can cause a fire. 	
<p>PROHIBITED</p> 	





 WARNING Violating following instructions can cause slight wound or damage the appliance.	
<p>Keep the desiccant out of children's reach.</p> <ul style="list-style-type: none"> If not, they may eat it. 	<p>Install the printer on the stable surface.</p> <ul style="list-style-type: none"> If the printer falls down, it can be broken and you can hurt yourself.
<p>PROHIBITED</p> 	<p>PROHIBITED</p> 
<p>Use only approved accessories and do not try to disassemble, repair or remodel it for yourself.</p> <ul style="list-style-type: none"> Call your dealer when you need these services. 	<p>Do not use the printer when it is out of order. This can cause a fire or an electrocution.</p> <ul style="list-style-type: none"> Switch off and unplug the printer before calling your dealer.
<p>DISASSEMBLING PROHIBITED</p> 	<p>TO UNPLUG</p> 
<p>Do not let water or other foreign objects in the printer.</p> <ul style="list-style-type: none"> If this happened, switch off and unplug the printer before calling your dealer. 	
<p>PROHIBITED</p> 	

Table of Contents

1. Unpacking & Repacking	5
2. Samsung Label Printer	6
3. Connecting the Power Supply	7
4. Connecting the Interface Cable	8
5. Installing or Replacing the Paper Roll	9
6. Setting the Dip Switches	10
7. The Self Test	11
8. LED Display	12
9. Pause / Restart	12
10. Gap sensor auto-calibration	13
11. The Peel-off	14
12. Using Fan Fold Paper	15
13. Auto Cutter (Option)	16
14. Cleaning Head	17
15. Memory Switch Setting	18
16. Install and Uninstall Windows Driver	20

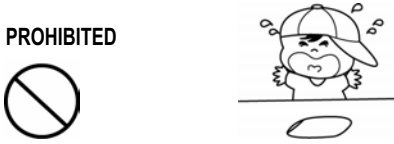
1. Unpacking & Repacking

Your printer box should include these items. If any items are damaged or missing, please contact your dealer for assistance.

Note : Please keep the packing materials(①,②,④,⑥) for future repacking to send a printer for repairs.

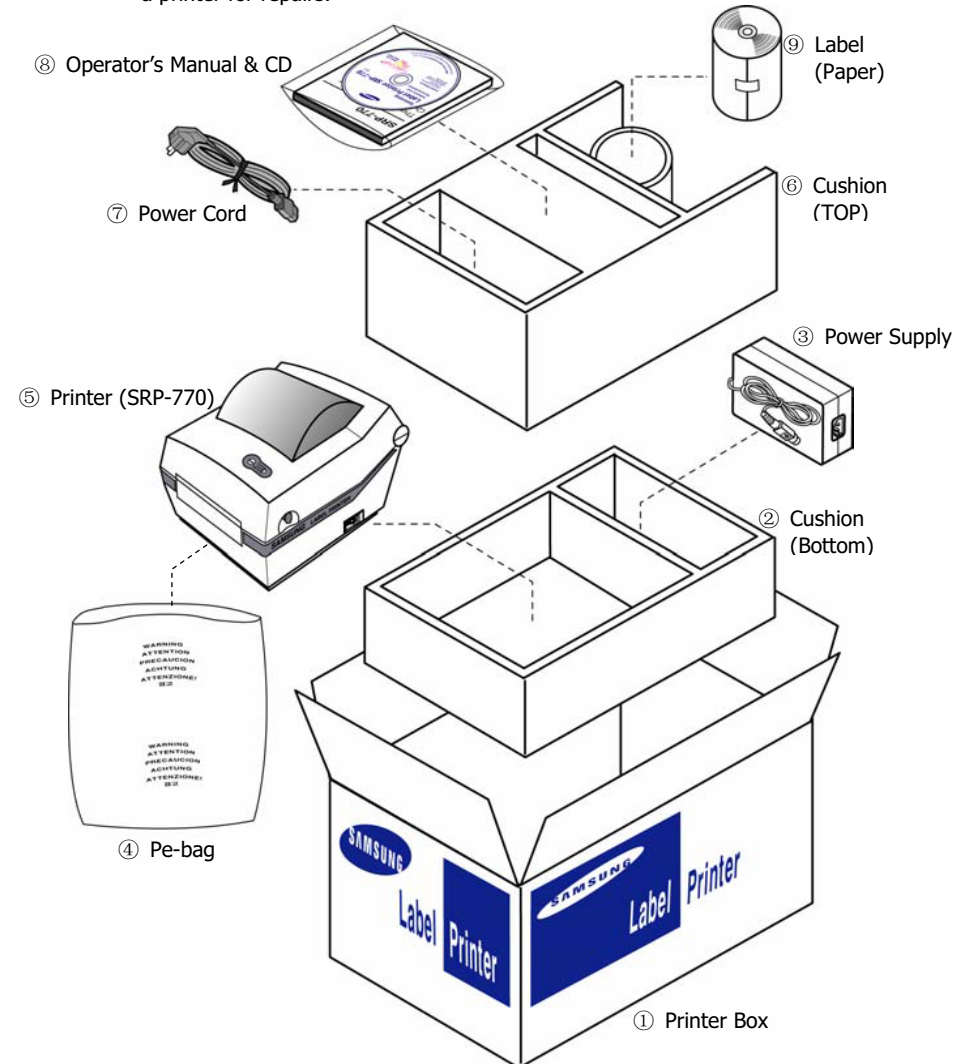

※ You can repack the printer package in above numeric order(①~⑨)

2. Samsung Label Printer

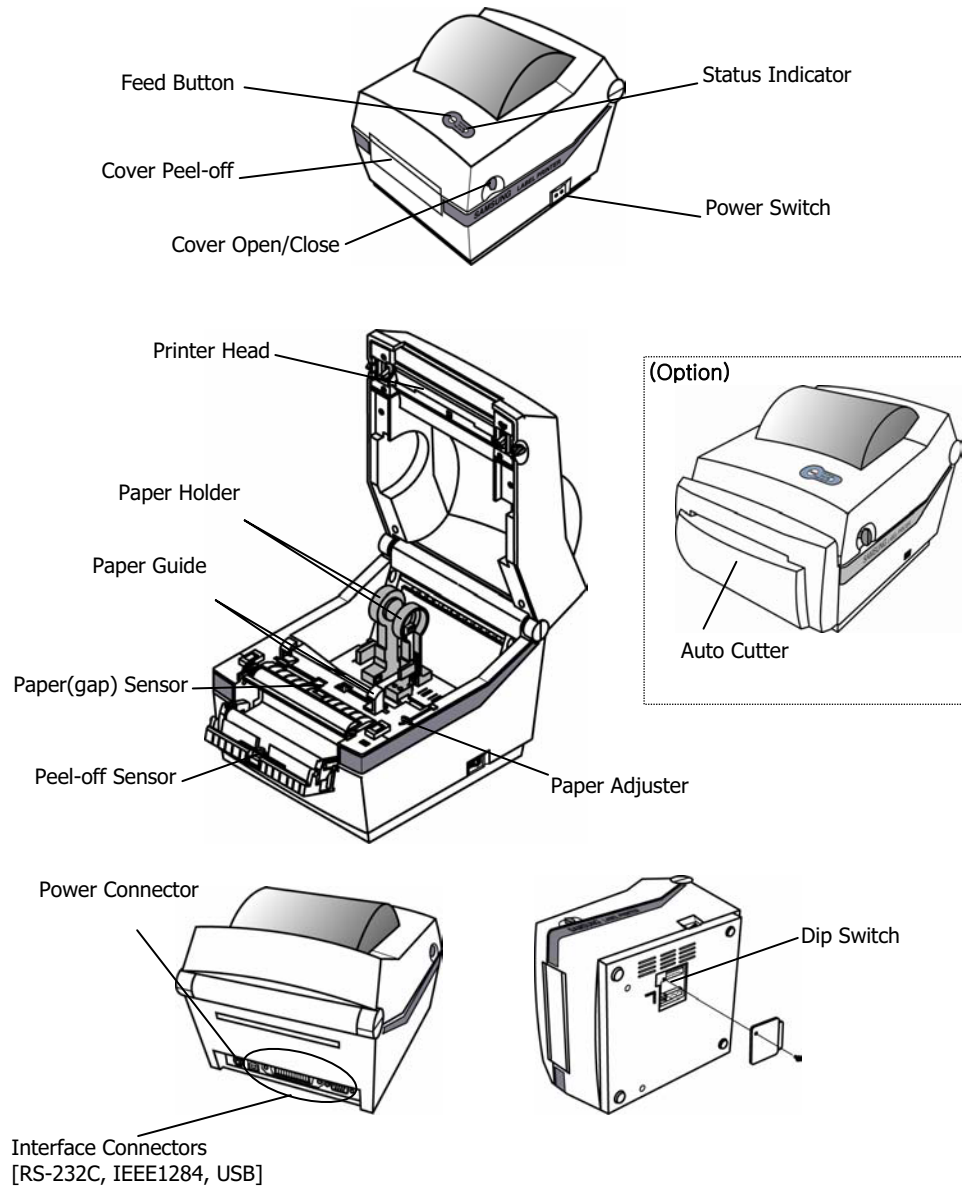

3. Connecting the Power Supply

CAUTIONS:

When connecting or disconnecting the power supply from the printer, make sure that the power supply is not plugged into an electrical outlet. And the power supply's rated voltage and your outlet's voltage do not match, contact your dealer for assistance. Then do not plug in the power cord. Otherwise, you may damage the power supply or the printer.

1. Make sure that the printer's power switch is turned off, and the power supply's power cord is unplugged from the electrical outlet.
2. Check the label on the power supply to make sure that the voltage required by the power supply matches that of your electrical outlet.
3. Plug in the power supply's cable as shown below. Notice that the flat side of the plug faces down.

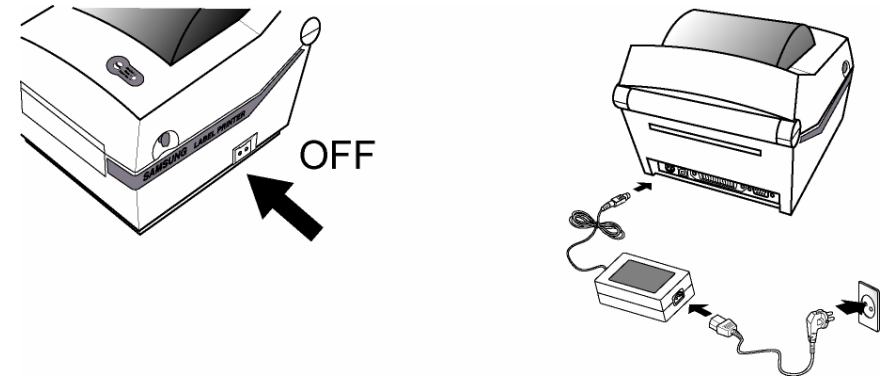

4. Connecting the Interface Cable

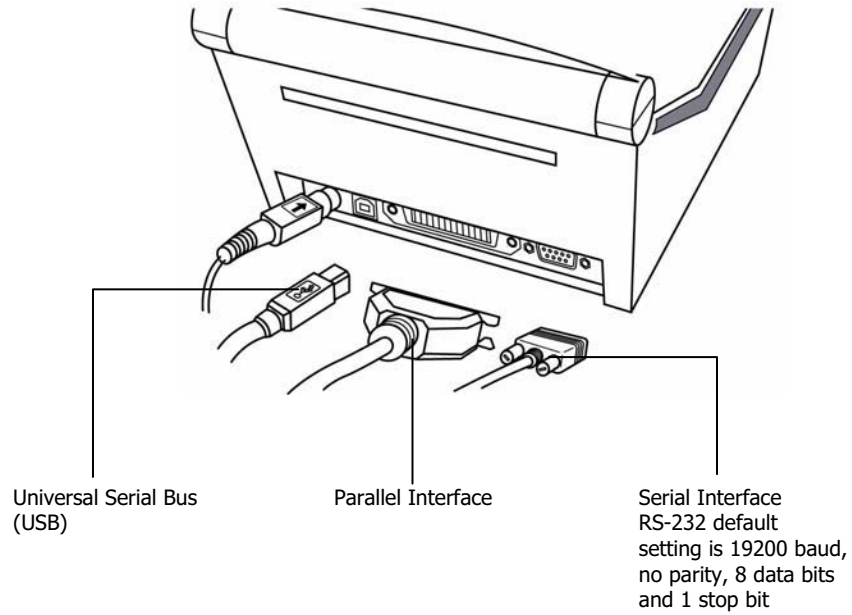

5. Installing or Replacing the Paper Roll

1. Open Cover

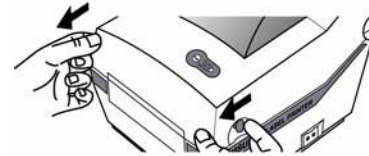

2. Open Guides

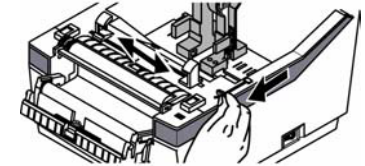

3. Install Roll

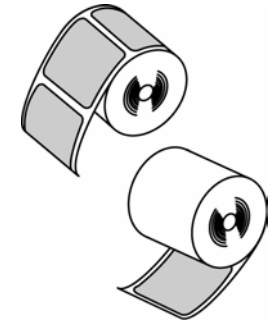
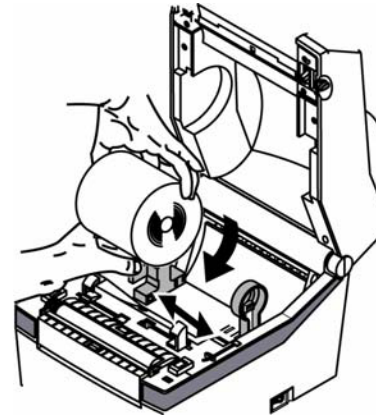

4. Close Guides to the Width of the paper

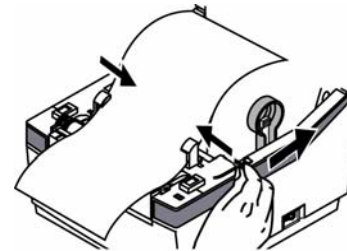

5. Close Cover



6. Setting The Dip Switches

6-1. Setting the Dip Switches

The Dip Switches are located on the bottom of the printer. The Dip Switches are used to set the Printer to perform various functions. Follow these steps when changing Dip Switches setting :

1. Turn the printer power switch off.
2. Remove the screw on the bottom of the printer and open the bracket.
3. Flip the Dip Switches using tweezers or another narrow-ended tool. Switches are **off** when up and **on** when down in the Figure below.
4. The new setting takes effect when you turn on the printer.

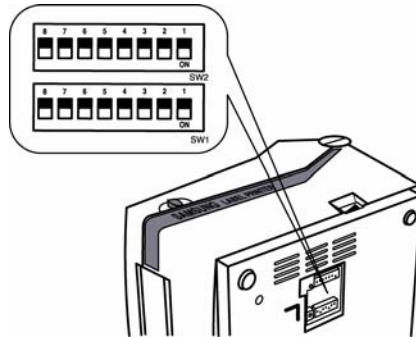

Note : Always change Dip Switch settings only when the printer is turned off.

6-2. Functions of Dip Switches

6-2-1. Dip S/W 1

No	Functions	Details			
1	Speed Selection	1	Speed		
		Off	4.0 ips		
		On	5.0 ips		
2	Density Selection	4	3	2	Density
		Off	Off	Off	13
		Off	Off	On	14
		Off	On	Off	15
		Off	On	On	16
		On	Off	Off	17
		On	On	Off	18
		On	On	On	19
5	Exhibition Selection	Off	Normal mode		
		On	Demo mode		
6	Media Selection	Off	Label Paper		
		On	Thermal Continuous Paper		
7	Auto Cutter	Off	Without Auto Cuter		
		On	With Auto Cutter		
8	Near End Sensor Status	Off	Enable		
		On	Disable		

6-2-2. Dip S/W 2

No	Functions	Details		
1,2	Baud Rate	2	1	Baud Rate
		Off	Off	9,600 bps
		Off	On	19,200 bps
		On	Off	57,600 bps
		On	On	115,200 bps
3	Media Detection	Off	Detect Gap	
		On	Detect Black-mark	
4	Reserved	--		
5	Emulation	Off	SAMSUNG command	
		On	Emulation	
6	Busy Condition	Off	Receive Buffer Full	
		On	*Offline *Receive Buffer Full	
7	Reserved	--		
8	Long label Split printing	Off	Disable	
		On	Enable	

7. The Self Test

The self-test checks whether the printer has any problems. (You cannot perform this procedure if using the printer's label peel-off option) If the printer does not function properly, contact your dealer. The self-test checks the following;

1. Make sure that paper roll has been installed properly.
2. Turn on the power while holding(2sec) down the FEED button. The self-test begins.
3. The self-test prints the current printer status, which provides the control ROM version and the DIP switch setting.

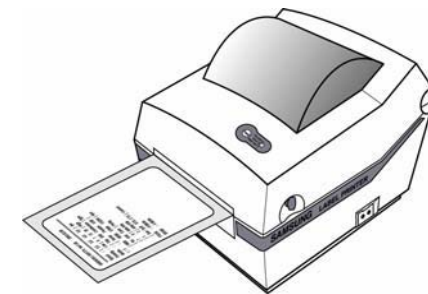
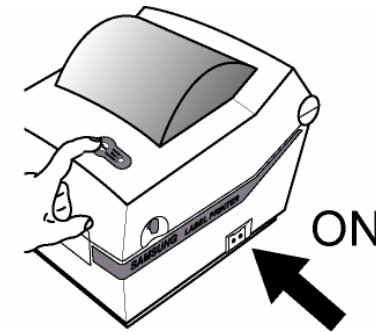

8. LED Display

LED display indicates the printer status.

1. Green LED on
 - The printer waits for the data from Host (PC) in normal mode.
2. Orange LED on
 - It means paper gap sensing error. It becomes on when the printer fails to detect the paper or paper jam occurred. When fails to detect the paper correctly use Auto-Calibration function.
3. Red LED on
 - The printer has stopped by pressing FEED button. It restarts printing when pressed again.
4. Green LED blinking
 - 1) TPH (Thermal Printing Head) overheated or ;
 - 2) The printers is waiting for the button input to run Auto-Calibration function.
5. Orange LED blinking
 - No paper. Make sure the paper is loaded correctly.
6. Red LED blinking
 - 1) The printer cover is open or ;
 - 2) Auto cutter has error such as paper jam in case of auto cutter built-in model.

9. Pause / Restart

Press FEED button to pause at the middle of labels printing.

1. Pause
 - Press FEED once. Printer stops after on-going printing and Red LED becomes on.
2. Restart
 - Press FEED once again. It restarts printing in a queue.

10. Gap Sensor Auto-Calibration

Gap sensor auto-calibration is used when the printer does not detect a gap on the label paper correctly. Generally a printer is set to detect most of gap types but sometimes it fails to detect and keep feeding the paper without a stop when special paper used. In such case, use gap sensor auto-calibration function for a proper detection.

1. Make sure that paper roll has been installed properly.
2. Turn on the power while holding down FEED button with cover open.
Then the Green LED blinks.

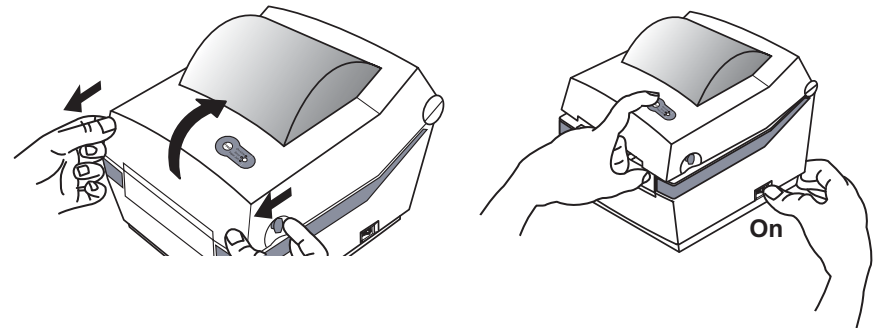

3. Close the cover and guide message is printed automatically.
Then a printer waits for input with red LED on.
4. Press FEED button once to initialize gap sensor and set it back to the factory setting. LED changes to Orange.
5. Press FEED button twice to run auto-calibration function.
LED changes first to Orange and second to Green.
It feeds 2-3 papers while auto-calibration executed.
Make sure to press a button one by one while checking LED changes.
6. Saved sensing value remains valid at power off unless otherwise above gap sensor initialization is executed again.

11. The Peel-off

This function is used to separate label from liner automatically.

CAUTIONS:

- 1) Peeler is for Label Paper only.
- 2) When the peeler switch is on, label is not printed before when the previous printed label is taken off from the peeler.
- 3) When the peeler function is not used set peeler switch off. With this switch on printer may not work correctly.

- 1. Open the peel-off cover and turn on peeler switch. (Check if Peeler LED is on.)

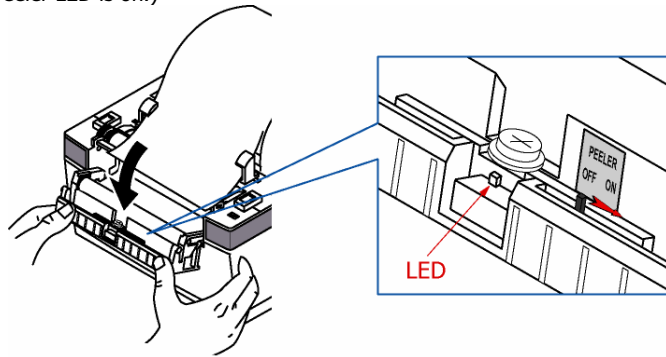

- 2. Remove the paper and insert the paper through slot.

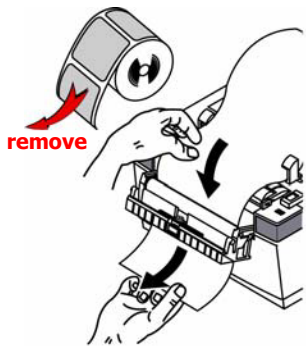

- 3. Adjust the paper guides and close the cover.

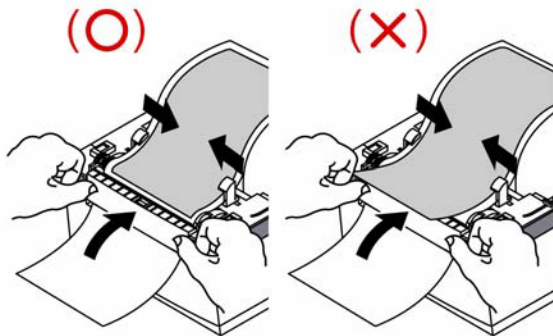

- 4. Turn off and on the printer.

12. Using Fan Fold Paper

Insert paper through both the rear slot and guides. Adjust holders and guides to the width of the paper.

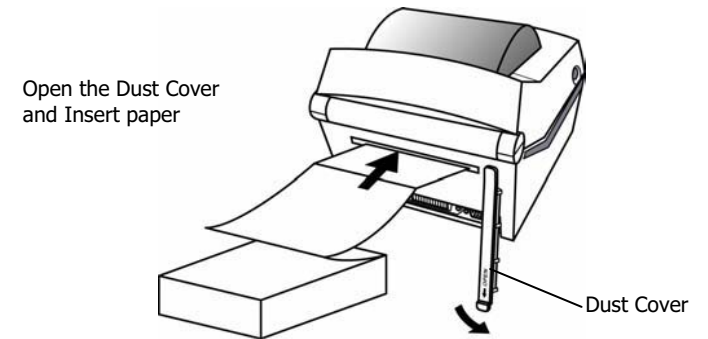

Adjust holders papers and paper Fixed

Adjust Guides

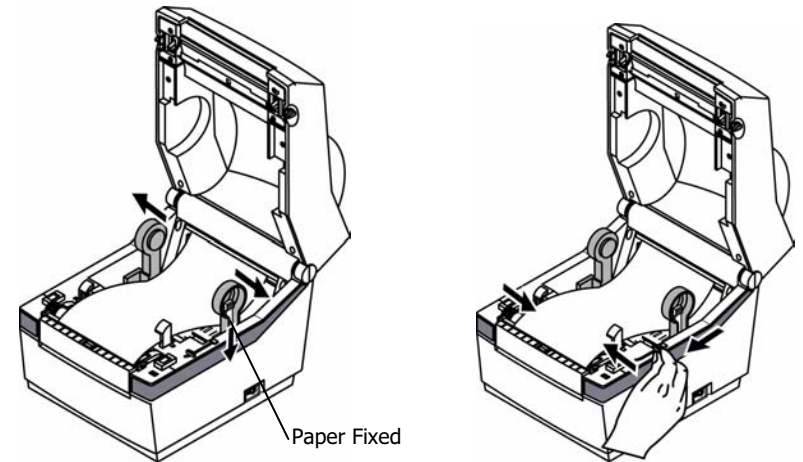

13. Auto Cutter (Option)

Auto cutter should be used for continuous paper only. (i.e. roll paper)

1. Open the Dip switch cover, and make the switch 1 number 7 "On".
(Refer to printer mode setting at Chapter 6.)
2. Put a paper roll into the printer and close the cover.

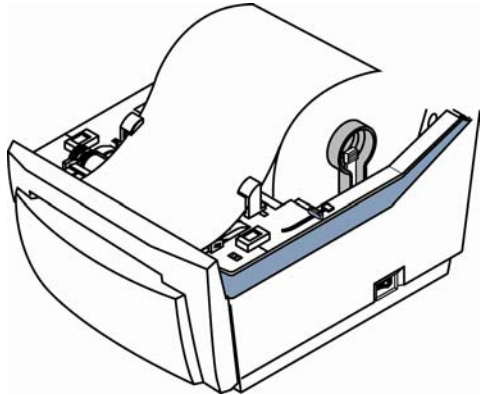

CAUTIONS: (Partial cut)

Once the printer cut the paper, remove the receipt in order for next printing. Otherwise the receipt could be back into the printer and the cutter would cut it again.

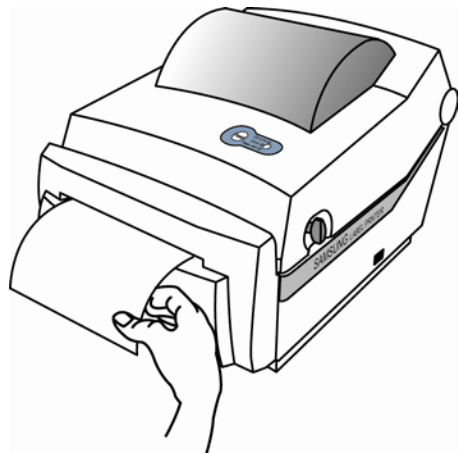

14. Cleaning Head

Paper dust on the heating elements may lower the printer quality. In this case, clean the print head as follows :

CAUTIONS:

- 1) Turn Off the printer power before cleaning.
- 2) Note that the thermal head becomes very hot during normal operation, creating the danger of burn injury. Be sure to wait for about 2~3 minutes after turning printer power off before beginning the cleaning.

1. Open the printer cover.
2. Clean the thermal element (the area which is marked a thin black line) of the thermal head with a cotton swab moistened with a alcohol solvent (ethanol, methanol, or IPA).
3. After confirming that the alcohol solvent has been dried up completely, close the cover-open.

- Note 1) Never touch the thermal element with your hand, then the thermal element can be damaged.**
2) Don't scratch the printer head.

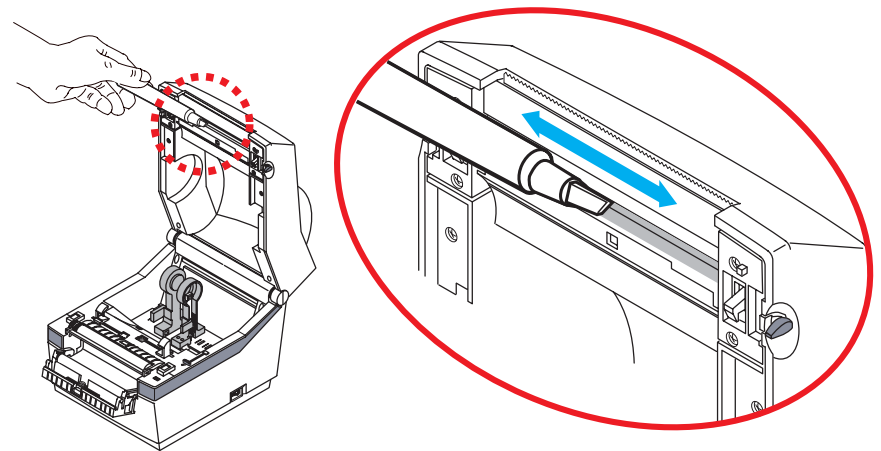

※ Clean it up when you replace every roll of paper to prevent the quality deterioration.

15. Memory Switch Setting

1. Models : SRP-770II, SRP-780

2. Features

It helps users through the setting of code pages, serial setting, paper size and print density as necessary.

3. How to use

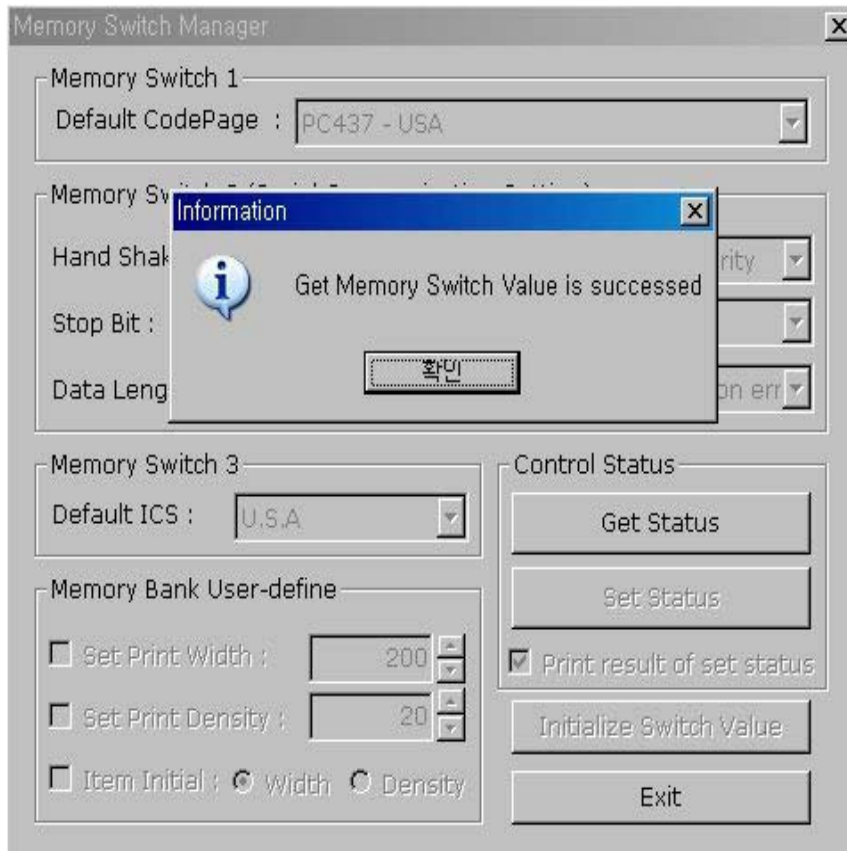

① Press **Get Status** button and it displays the current setting.

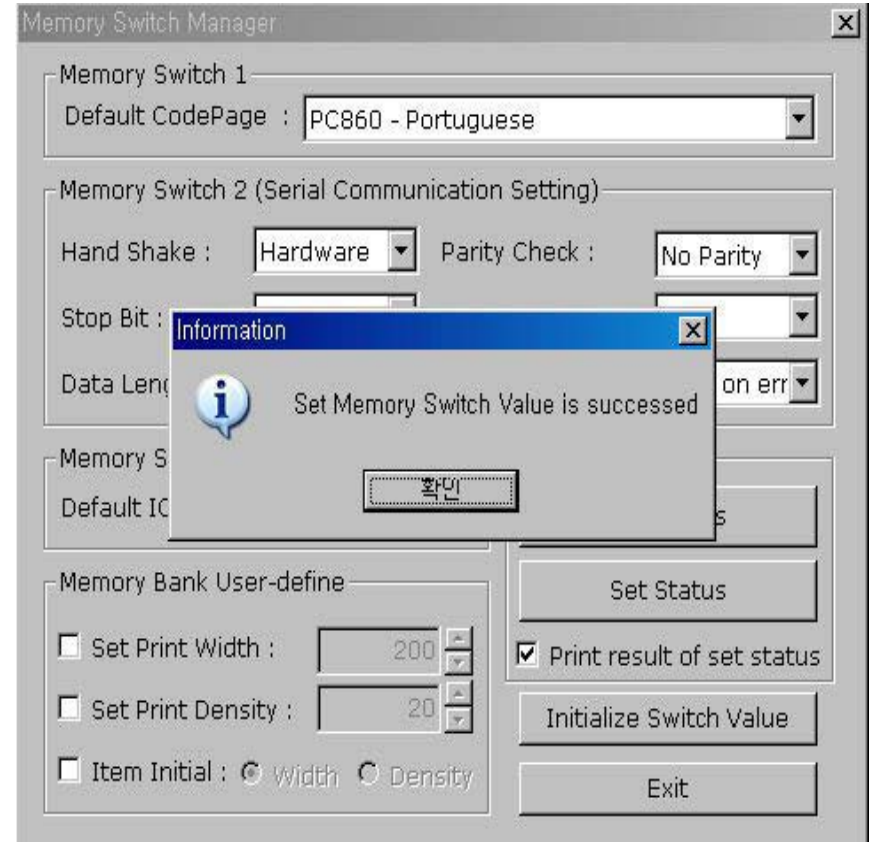

② Press **Set Status** button after changing the setting as you need.
Then it saves as default.

16. Install and Uninstall Windows Driver

13.1 Download install-program from Website

- (1) Execute web-browser.(Ex: Internet Explorer)
- (2) Type <http://www.bixolon.com>
- (3) Connect website.
- (4) In "Quick menu", click download button.
- (5) Download "SRP-770II_V3.X.X.exe" in SRP-770II section.

13.2 Install Windows Driver

13.2.1 Serial Parallel interface

- (1) Double click "SRP-770II_V3.X.X.exe" file.
- (2) Click "Next" Button.

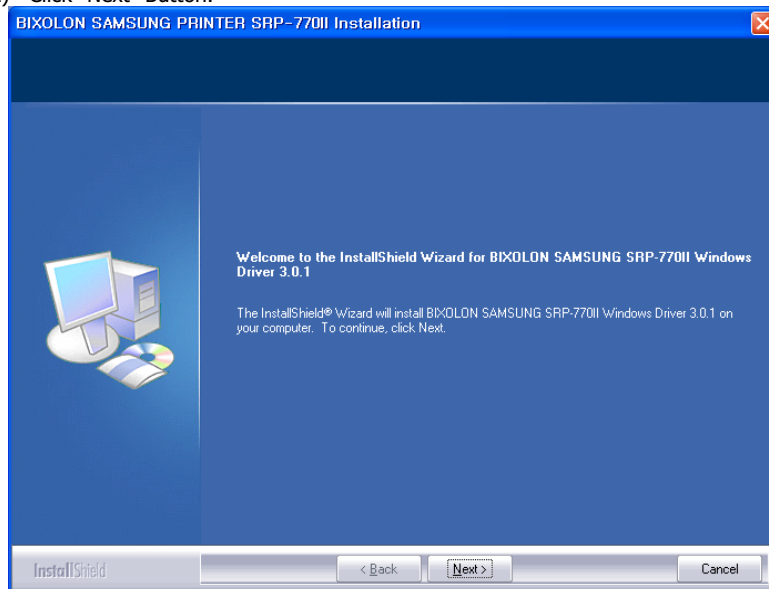

- (3) Click "Install" Button.

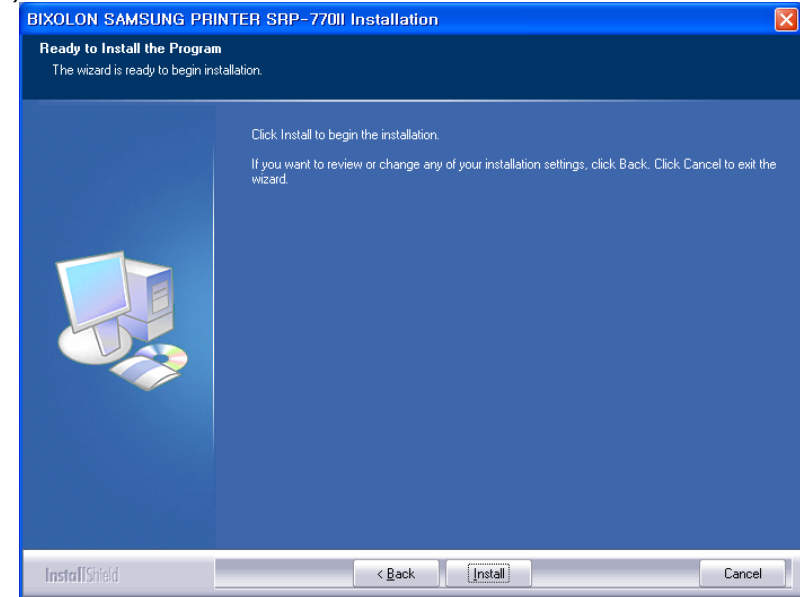

- (4) Select operating system type.

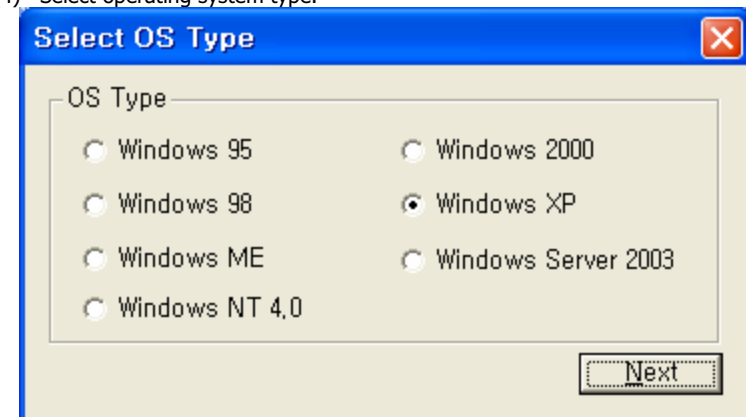

(5) Select interface (port) type.

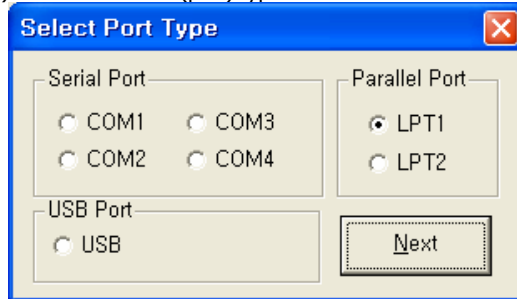

(6) Please click "Continue Anyway".



*** If you can see this dialog, don't worry comment of dialog. Printer and driver works well. Please click "Continue Anyway" button.**

(7) Please reboot computer.



13.2.2 USB interface

A. Windows 95/98/ME

(1) Double click "SRP-770II_V3.X.X.exe" file.

(2) Click "Next" Button.

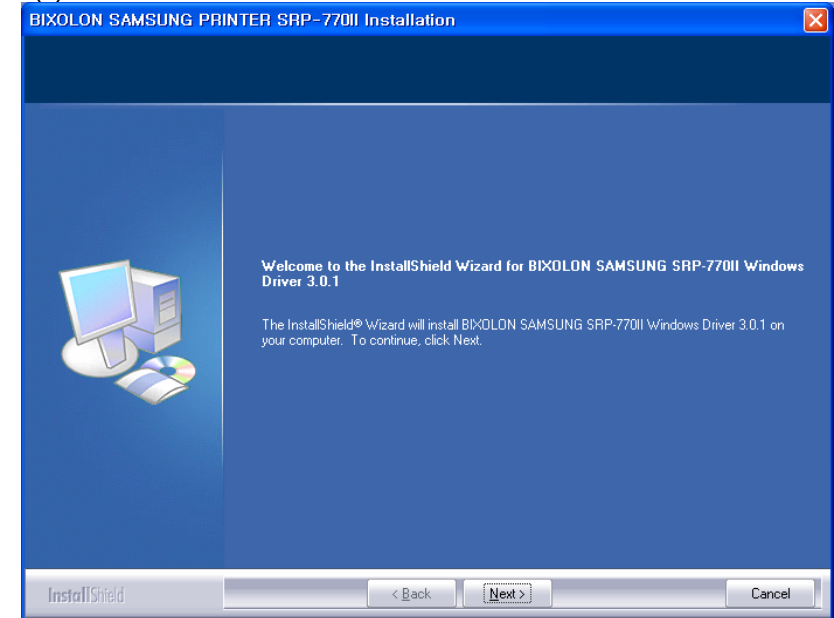

(3) Click "Install" Button.

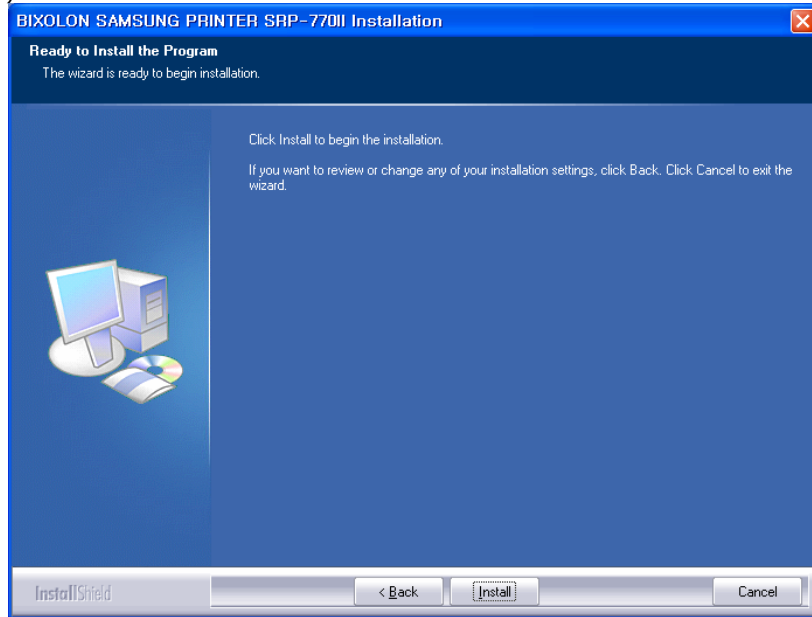

(4) Select operating system type.

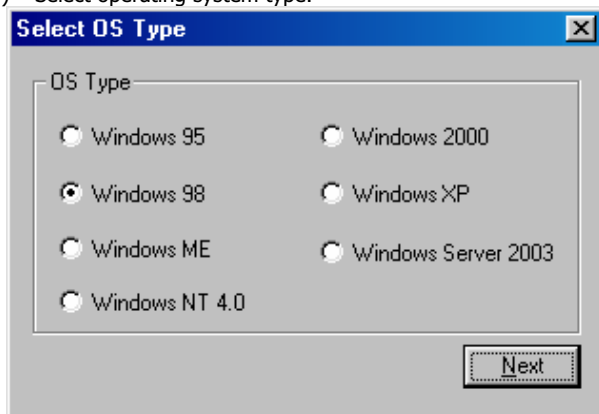

(5) Select "USB" interface (port) type.

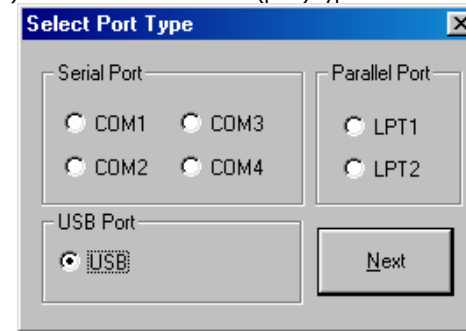

(6) Please turn-off printer and turn-on printer.

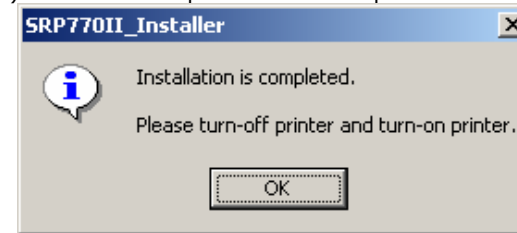

(7) When "Add new hardware wizard" for install "USB print support" driver pops up, click "Next" button.



- (8) Please click "Next" button three times.
- (9) When "USB print support" driver is installed, your system automatically restart after 10 seconds.

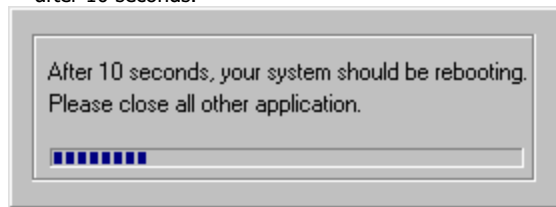

- (10) After the system restart, please turn-on printer.

B. Windows NT/2000

- (1) Double click "SRP-770II_V3.X.X.exe" file.
- (2) Click "Next" Button.

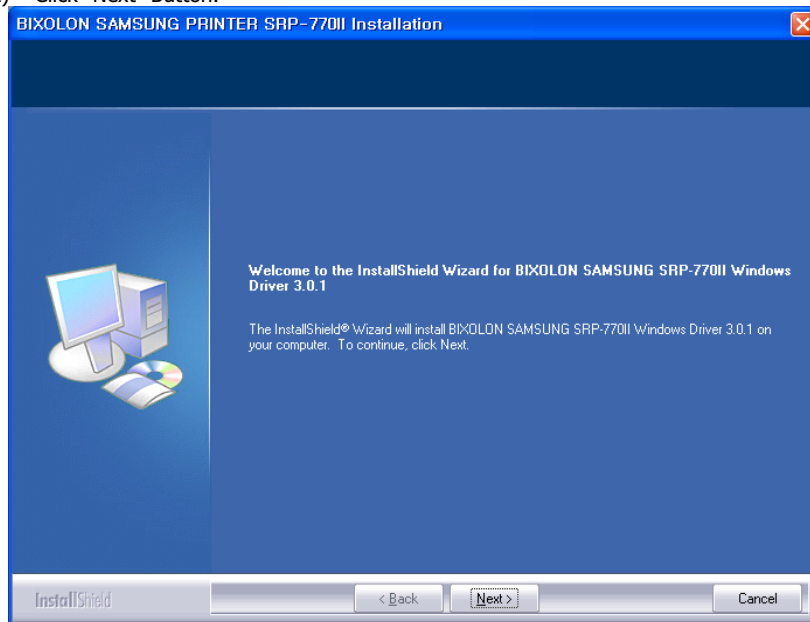

- (3) Click "Install" Button.

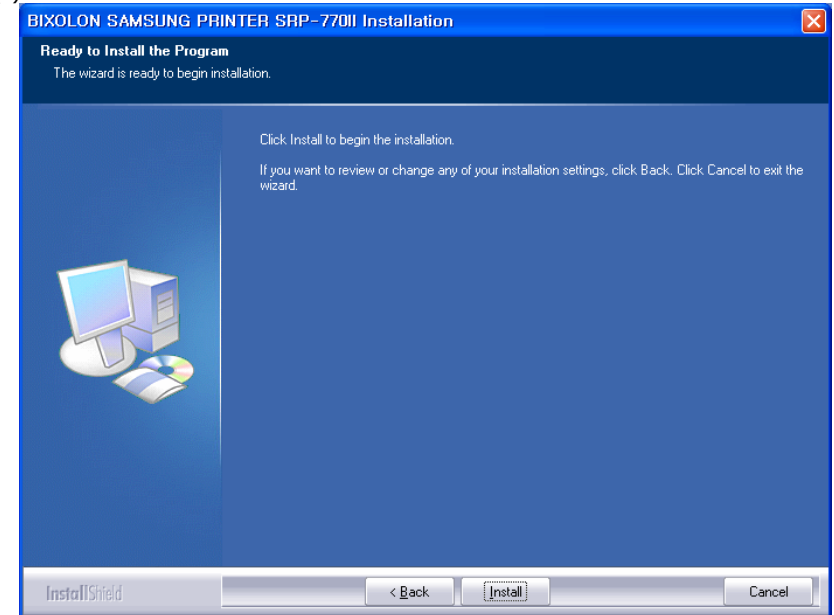

- (4) Select operating system type.

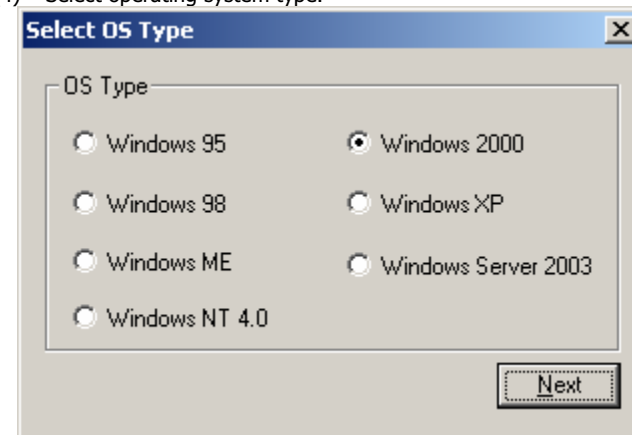

(5) Select "USB" interface (port) type.

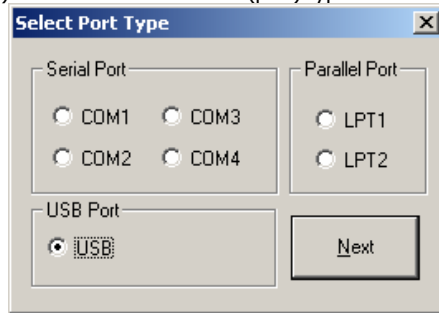

(6) Please turn-off printer and turn-on printer.



*** If you can see this dialog, don't worry comment in dialog. Printer and driver work well. Please click "Yes" button.**

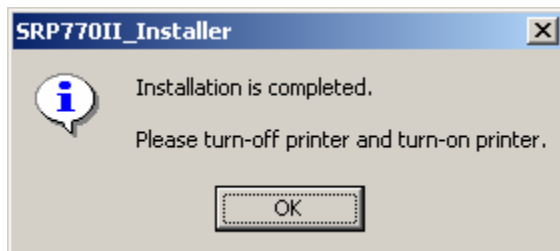

C. Windows XP/2003 Server

(1) Double click "SRP-770II_V3.X.X.exe" file.

(2) Click "Next" Button.

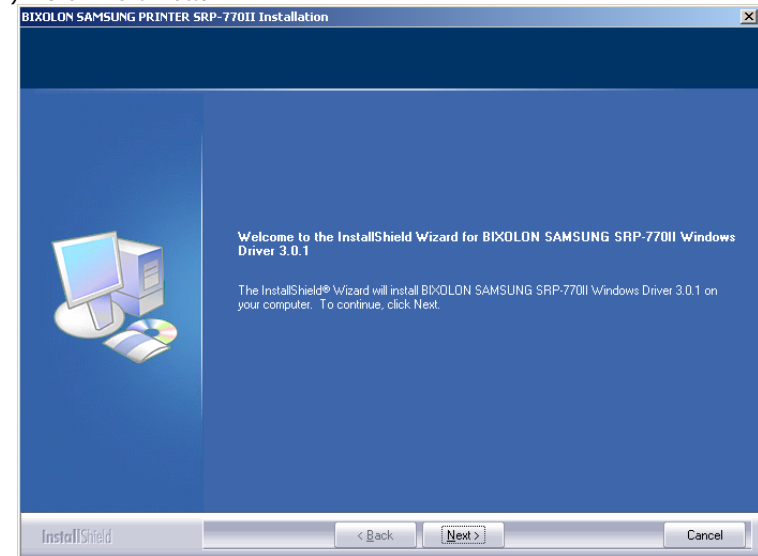

(3) Click "Install" Button.

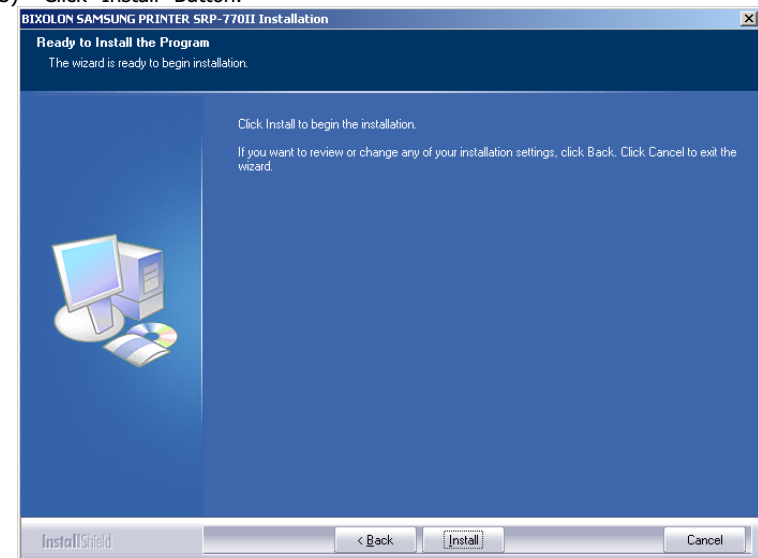

(4) Select operating system type.

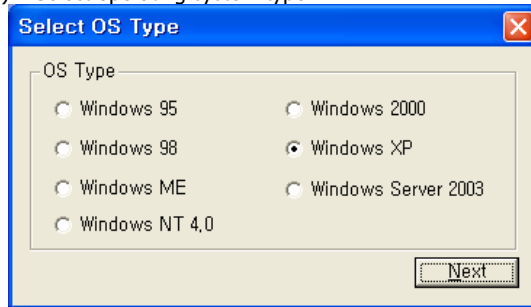

(5) Select "USB" interface (port) type.

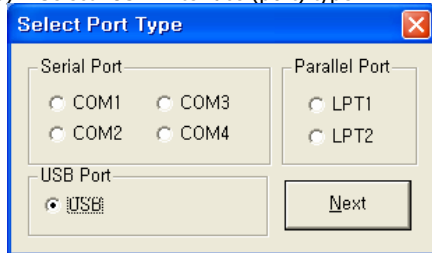

(6) Please turn-off printer and turn-on printer.



*** If you can see this dialog, don't worry comment in dialog. Printer and driver work well. Please click "Continue Anyway" button.**

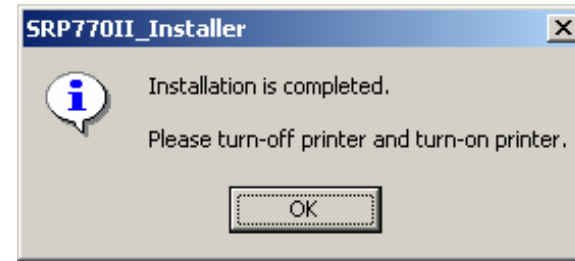

(7) If "Add new hardware wizard" for install "SAMSUNG SRP-770II" driver pops up, click "Next" button.



(8) Please click "Next" button until you can see "Finish" button.



***If you can see this dialog, don't worry comment in dialog. Printer and driver work well. Please click "Continue Anyway" button.**

(9) Please click "Finish" button.

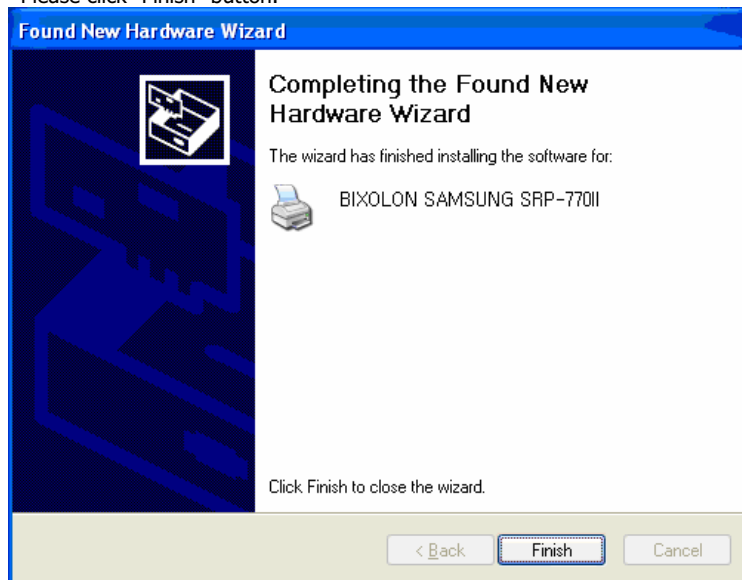

13.3 Uninstall Windows Driver

- (1) Click on the Start button, and then click on Settings > Control Panel.
- (2) Double click "Add/Remove Programs" icon.
- (3) Select "BIXOLON SAMSUNG SRP-770II POS Windows Driver 3.X.X".
- (4) Click "Change/Remove" button.
- (5) Select printer to remove.

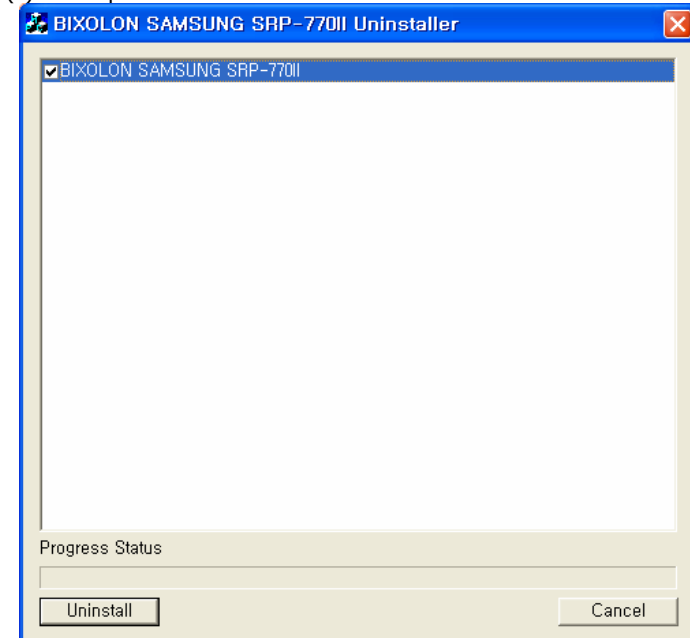

- (6) Click "Uninstall" Button.
- (7) Please reboot computer.



13.4 Printer Settings

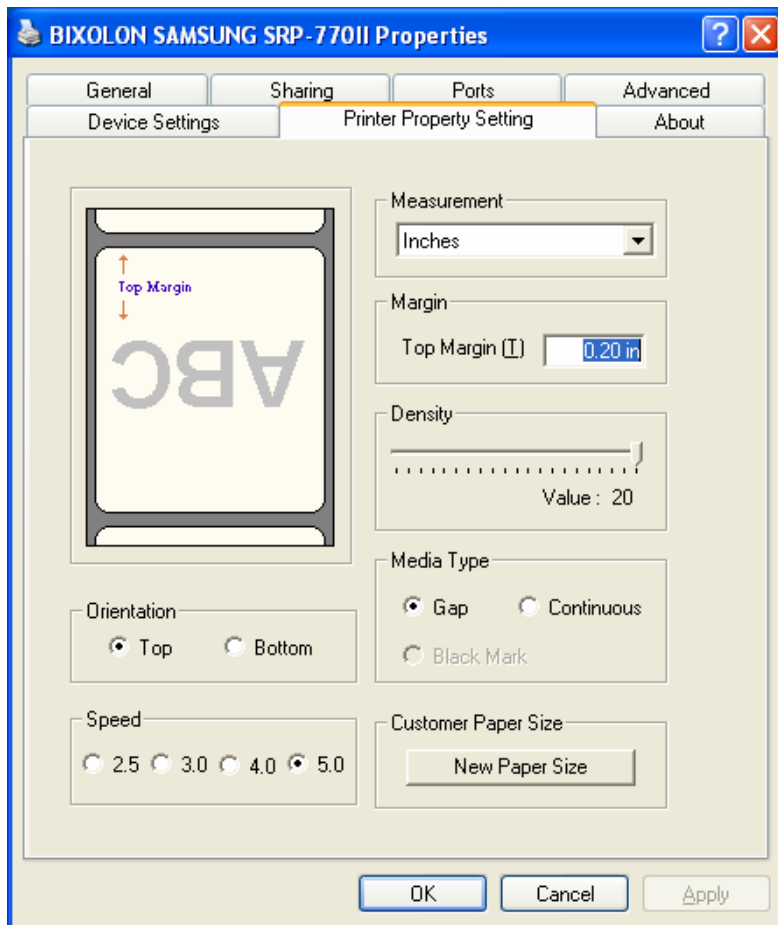

- 1) Measurement: Select measurement of "Top Margin". (Inch or millimeters)
- 2) Top Margin: top margin value of paper
- 3) Density: Select density of printing quality. (0 ~ 20)
- 4) Media Type: Select paper media type. ("Black Mark" is under development)
- 5) Orientation: Set printing direction.
- 6) Speed: Set printing speed. (2.5 ~ 3.0)

7) Customer Paper Size

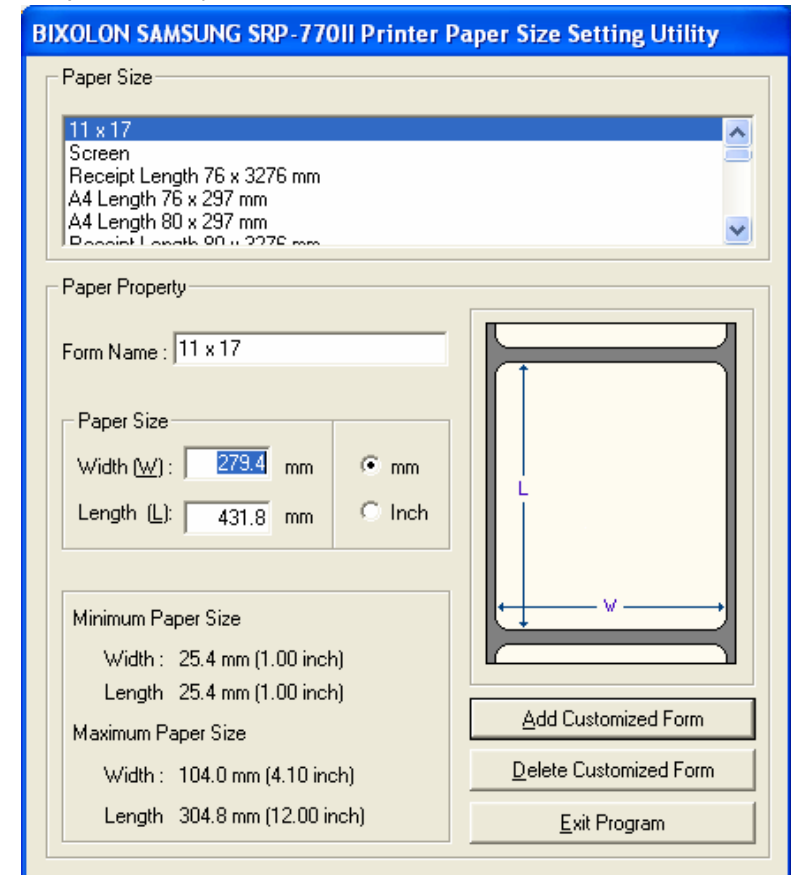

- a) Add Customized Form: Create new customized form. Customer must type "Form Name", "Width" and "Length". Width and Length in customized form must be the number in the range from Minimum to Maximum size.
- b) Delete Customized Form: You can delete customized form but default form may not be deleted.
- c) Exit Program: Exit utility program.

【 Specification 】

Printing method	Thermal line printing	
Dot density	203 dpi (8 dot/mm)	
Printing width	25.4 ~ 101.6 mm	
Paper width	38.1 ~ 104 mm	
Printing speed	127 mm/sec	
Receive Buffer Size	32K Byte	
<p>※ Note : Printing speed can be different, depending on the data transmission speed and combination of control commands.</p>		
Supply voltage	Input voltage	100~240V AC
	Frequency	50/60 Hz
	Output voltage	DC 24V
Environmental conditions	Temperature	5 ~ 45 °C (Operating) -25 ~ 70 °C (Storage)
	Humidity	30 ~ 80 % RH (Operating) 10 ~ 90 % RH (Storage) ; Except for paper
LIFE	Mechanism Head	10,000,000 lines 5×10 ⁷ pulse (50km)
MCBF	Mechanism	20,000,000 lines



This marking shown on the product or its literature, indicates that it should not be disposed with other household wastes at the end of its working life. To prevent possible harm to the environment or human health from uncontrolled waste disposal, please separate this from other types of wastes and recycle it responsibly to promote the sustainable reuse of material resources. Household users should contact either the retailer where they purchased this product, or their local government office, for details of where and how they can take this item for environmentally safe recycling. Business users should contact their supplier and check the terms and conditions of the purchase contract. This product should not be mixed with other commercial wastes for disposal.

※ **All specifications are subjected to change without notice.**