

User's Manual

SPP-R200

Mobile Printer

Rev. 1.00

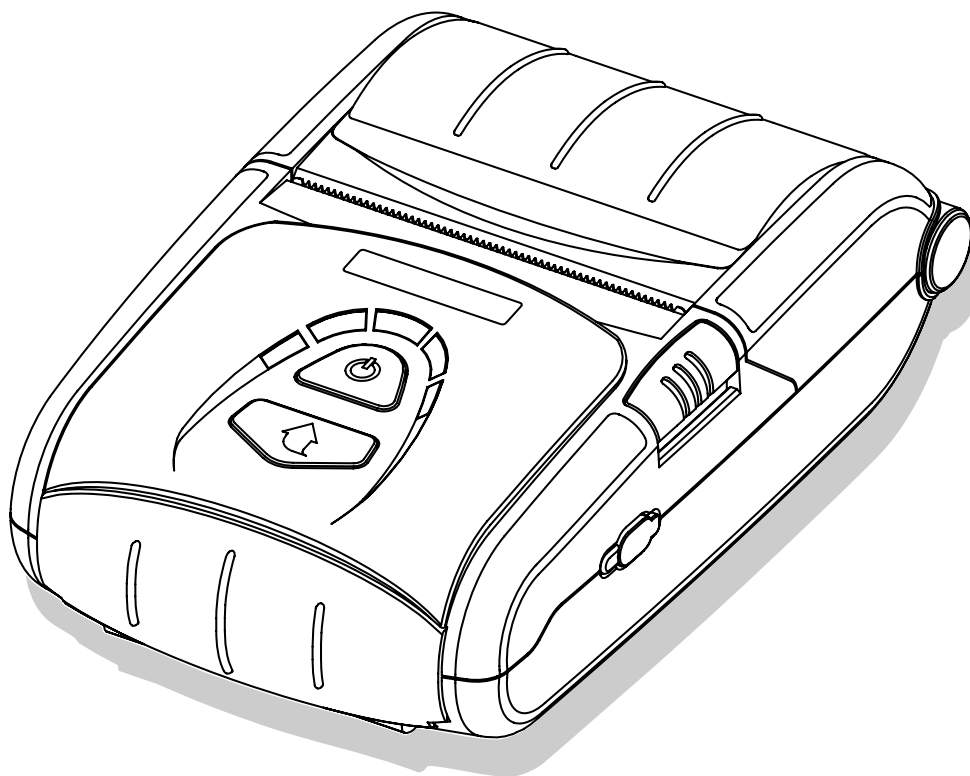

■ Table of Contents

※ Manual Information & Usage Precautions	3
1. Content Confirmation	10
2. Product Part Names	11
3. Installation & Usage	12
3-1 Battery Installation.....	12
3-2 Battery Charging	12
3-3 Battery Holder (Optional) Usage	13
3-4 Cigarette Lighter Jack Charger (Usage) Usage.....	13
3-5 Paper Installation	14
3-6 Belt Strap Usage.....	15
3-7 Leather Case (Optional) Usage	16
3-8 Control Panel Usage.....	17
3-9 MSR Usage.....	18
4. Self-Test	18
5. Peripherals Connection	20
5-1 Bluetooth Connection.....	20
5-2 Interface Cable Connection	20
6. Printer Cleaning	21
7. Appendix	22
7-1 Specifications.....	22
7-2 Certification	23
7-3 Label Types.....	23

■ Manual Information

This user manual contains basic information for product usage as well as for emergency measures that may be required.

※ The following separate manuals provide more detailed content on various technological issues and areas.

1. Windows CE Module Program Manual

This manual provides information on the dll files required for Windows CE application program development.

2. Windows Driver Manual

This manual provides information on installation and main functions of the Windows Driver for this product.

4. Unified Utility Manual

This manual provides information on the software used to select functions of this product, modify operation conditions, etc.

- VMSM (Virtual Memory Switch Manager)
: As a function that sets the basic operation conditions of the product, the use of non-hardware control, software-based virtual switches is explained.
- NV Image Download Manager
: The downloading of image files, such as logos, intended for repetitive printing is explained.
- Firmware Download Manager
: The downloading and installation of the latest Firmware, which is subject to ongoing modification for the enhancement of product performance, are explained.

5. Bluetooth Connection Manual

This manual provides information on the connection of this product with devices equipped with Bluetooth functionality (PDAs, PCs, etc.). The devices included are as follows.

- PDAs:
 - Intermec PDA (Device: CN2B, OS: Pocket PC 4.20.0)
 - SYMBOL PDA (Device: SYMBOL MC70, OS: Windows Mobile 5.0)
 - HP PDA (Device: iPAQ hx2700, OS: Windows Mobile 5.1.1702)
 - Mobile Compia PDA (Device: M3, OS: WinCE 5.0)
 - InnoTeletek PDA (Device: MC3000, OS: WinCE 4.2)
- Bluetooth Dongle (BlueSoleil IVT Stack)

6. Commands Manual

This manual provides information on the protocol and functions of the control commands that can be used with this product.

7. Code Pages Manual

This manual provides information on each character code page that can be used with this product.

We at BIXOLON maintain ongoing efforts to enhance and upgrade the functions and quality of all our products. In following, product specifications and/or user manual content may be changed without prior notice.

■ Safety Precautions

In using the present appliance, please keep the following safety regulations in order to prevent any hazard or material damage.



WARNING

Violating following instructions can cause serious injury or death.

Do not plug several products in one multi-outlet.

- This can provoke over-heating and a fire.
- If the plug is wet or dirty, dry or wipe it before usage.
- If the plug does not fit perfectly with the outlet, do not plug in.
- Be sure to use only standardized multi-outlets.

PROHIBIT

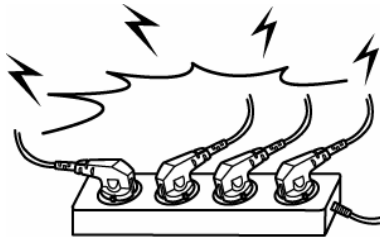

You must use only the supplied adapter.

- It is dangerous to use other adapters.

PROHIBIT



Do not pull the cable to unplug.

- This can damage the cable, which is the origin of a fire or a breakdown of the printer.

PROHIBIT



Keep the plastic bag out of children's reach.

- If not, a child may put the bag on his head.

PROHIBIT



Do not plug in or unplug with your hands wet.

- You can be electrocuted.

PROHIBIT

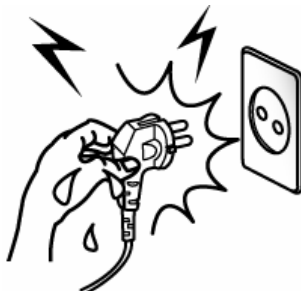

Do not bend the cable by force or leave it under any heavy object.

- A damaged cable can cause a fire.

PROHIBIT

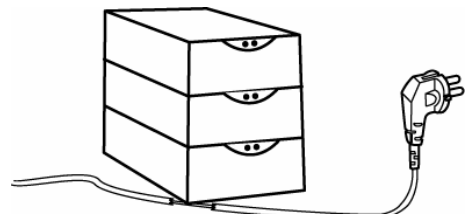



CAUTION

Violating following instructions can cause slight wound or damage the appliance.

If you observe a strange smoke, odor or noise from the printer, unplug it before taking following measures.

- Switch off the printer and unplug the set from the mains.
- After the disappearance of the smoke, call your dealer to repair it.

TO UNPLUG



Keep the desiccant out of children's reach.

- If not, they may eat it.

PROHIBIT



Install the printer on the stable surface.

- If the printer falls down, it can be broken and you can hurt yourself.

PROHIBIT

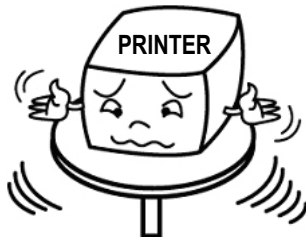

Use only approved accessories and do not try to disassemble, repair or remodel it for yourself.

- Call your dealer when you need these services.
- Do not touch the blade of auto cutter.

DISASSEMBLING PROHIBITED

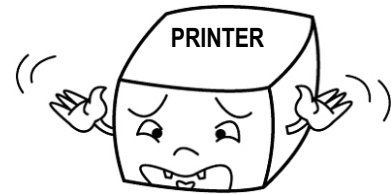

Do not let water or other foreign objects in the printer.

- If this happened, switch off and unplug the printer before calling your dealer.

PROHIBIT



Do not use the printer when it is out of order. This can cause a fire or an electrocution.

- Switch off and unplug the printer before calling your dealer.

TO UNPLUG



■ Battery Safety Precautions

Make sure to review the user manual carefully prior to product use.

Neglecting to heed the following instructions can result in battery overheating, combustion, explosion, damage and/or decline in performance and product life.

Danger

1. Do not allow water, seawater, etc. enter or leak into the battery interior. If the safety mechanism within the battery becomes burned out, any charging of the battery can result in abnormal electrical current flow and/or voltage that causes an abnormal chemical reaction, which may then cause the battery to overheat, ignite, and/or explode.
2. Do not use or leave the battery in a location exposed to high temperatures, such as next to a stove, etc. Excessive heat exposure can cause damage to the resin case and/or insulating materials, thus causing short circuits within the battery that may result in battery overheating, combustion, and/or explosion.
3. When charging the battery, use the exclusive charger or follow the charging requirements outlined by BIXOLON. Charging under conditions not included in such requirements (higher temperature, higher voltage/larger electrical current, use of a modified charger, etc.) can result in excessive battery charging and abnormal electrical current flow and/or voltage that causes an abnormal chemical reaction, which may then cause the battery to overheat, ignite, and/or explode.
4. The battery has clearly delineated plus and minus poles. When inserting the battery into the charger and/or product, make sure to confirm that the battery is properly aligned. Reverse insertion will cause reverse charging that can result in an abnormal chemical reaction, which may then cause the battery to overheat, ignite, and/or explode.
5. Do not place the battery in contact with an electrical power outlet and/or an automobile cigarette lighter jack. Doing so can inflict high voltage that causes excessive electrical current flow, resulting in battery overheating, combustion, and/or explosion.
6. Do not heat the battery or place it in a fire. Doing so can melt the insulating materials and/or damage the safety mechanism or safety equipment, allowing the electrolytic solution to ignite and resulting in battery overheating, combustion, and/or explosion.
7. Do not use the battery in reverse (+) and (-) alignment. Doing so during charging will cause reverse charging that can result in an abnormal chemical reaction. During use, unpredictable electrical current abnormalities can arise, causing battery overheating, combustion, and/or explosion.
8. Do not allow the battery's (+) and (-) poles to come into contact with any metals. In addition, do not carry or store the battery together with metal items, such as necklaces, hairpins, etc. Resulting short circuits within the battery can cause excessive electrical current flow, resulting in battery overheating, combustion, and/or explosion as well as potential overheating of the adjacent metal items (necklaces, hairpins, etc.).
9. Do not throw the battery or subject it to heavy shock. If the safety mechanism within the battery becomes burned out, any charging of the battery can result in abnormal electrical current flow and/or voltage that causes an abnormal chemical reaction, which may then cause the battery to overheat, ignite, and/or explode.

10. Do not pierce the battery with a sharp object, such as a nail, or hit it with a heavy object, such as a hammer, and take care not to step on the battery. The battery may rupture or become warped, causing short circuits within that may result in battery overheating, combustion, and/or explosion.
11. Do not solder the battery directly. The heat can melt the insulating materials and/or damage the safety mechanism or safety equipment, resulting in battery overheating, combustion, and/or explosion.
12. Do not disassemble and/or modify the battery. The battery contains safety equipment and a safety mechanism to prevent danger. Any damage to these components can cause battery overheating, combustion, and/or explosion.
13. Do not charge near a source of heat and/or under direct sunlight. Exposure to high temperatures causes the safety mechanism to activate, thus making charging impossible. In addition, any damage to the safety mechanism itself that may be caused by excessive heat can cause any charging of the battery to result in abnormal electrical current flow and/or voltage that causes an abnormal chemical reaction within the battery and/or battery overheating, combustion, and/or explosion.

Warning

1. Do not place the battery within the reach of small children to prevent any swallowing accidents. If a small child has swallowed the battery, consult a physician immediately.
2. Do not place the battery in a microwave oven and/or high voltage appliance. Doing so can cause rapid overheating and/or destruction of the sealing, resulting in battery overheating, combustion, and/or explosion.
3. Do not combine and use any battery of different capacity and/or type with the primary battery. Doing so can cause excessive electrical discharge during use or excessive charging during charging, resulting in an abnormal chemical reaction within the battery that can cause battery overheating, combustion, and/or explosion.
4. If during battery usage, storage, or charging, a strange odor or conditions differing from the normal, such as overheating, color changes, warping, etc., are detected, remove the battery from the product or charger and discontinue use. Continued use may cause battery overheating, combustion, and/or explosion.
5. When recharging, if the battery is not charged after the normal fixed charging time, discontinue charging. Continued charging can result in battery overheating, combustion, and/or explosion.
6. If the battery appears to be coated with condensation or emits a strange odor, immediately place it far away from any heat source. The condensation may be caused by a leak of electrolytic solution that can ignite to cause battery combustion and/or explosion.
7. If the battery is leaking electrolytic solution and any of the solution enters the eyes, immediately wash out with clean water, and then consult a physician to receive treatment. Neglecting to do so can cause permanent eye injuries.

⚠ Caution

1. Do not use or leave the battery in a location exposed to high temperatures or intense direct sunlight, such as within an automobile. Doing so can cause battery overheating and/or combustion. In addition, battery performance and product life may be reduced.
2. The battery contains a safety mechanism to prevent danger. Do not use the battery in a location that is prone to static electricity (above the amount covered by the manufacturer's product warranty) that can cause damage to this safety mechanism. Damage to the safety mechanism can result in battery overheating, combustion, and/or explosion.
3. The temperature ranges for battery usage are as follows. Any usage outside of these ranges can result in battery overheating and/or damage. In addition, battery performance and product life may be reduced.
 - Charging: 0 ~ 40°C
 - Product Usage: -20 ~ 60°C
 - Storage: -20 ~ 60°C (30 days)
 - Long-Term Storage: -20 ~ 40°C (90 days)
4. Please review the exclusive charger manual carefully for charging instructions.
5. If upon first use following purchase, a strange odor, overheating, and/or anything deemed out of the ordinary is detected, discontinue use and contact the dealer from which the product was purchased.
6. If a child must use the battery, the child's parent or legal guardian should clearly explain the instructions from the user manual prior to use. In addition, the parent or legal guardian should periodically confirm that usage is being conducted in accordance with user manual instruction during use.
7. Store the battery in a location that is out of the reach of small children. During usage, make sure to also place the charger and/or product out of the reach of small children.
8. If the battery is leaking electrolytic solution, and the solution comes in contact with the skin or clothing, immediately wash thoroughly with clean water. Contact with skin can result in skin disorders.
9. Make sure to review the user manual and precautions carefully prior to use. In addition, after carefully reviewing the user manual and precautions, place them in a secure location for future reference when needed.
10. As the improper exchange of the battery can pose the risk of explosion, replace only with batteries of the same type and grade as designated by the manufacturer. Dispose of used batteries per the instructions provided by the manufacturer.

⚠ Recommended

1. Review the user manual for instructions concerning insertion/removal of batteries into/from the product.
2. As the battery is slightly charged upon factory shipment, use it to confirm proper product operation upon purchase. If product operation cannot be confirmed or longer use of the product is required, use the exclusive charger to charge the battery.
3. To avoid improper use of the battery, review the product user manual carefully.
4. Do not charge the battery for long times in excess of the normal charging time indicated in the user manual.
5. If the battery is not to be used for a long period of time, remove it from the product and store in a location with low humidity. If the battery is stored while still inserted in the product in a highly humid location, oxidization may occur along with a decline in battery performance.
6. After product usage, make sure to turn power off. Neglecting to do so can cause a decline in battery performance.
7. A battery that has not been used over a long period of time may not be sufficiently charged. Even if the battery is not to be used, charge the battery to the status recommended by the manufacturer once every six months. Neglecting to do so can cause a decline in battery performance and product life.
8. If the battery terminal is dirty, use a dry cloth to wipe clean prior to use. Neglecting to do so can result in poor connection with the product causing power stoppages or failed charging.
9. Each battery has a product life. If the usage time of the product has become short, replace the battery. Wrap the terminals of used batteries with tape to insulate prior to disposal.

■ Other Precautions

The copyright for this user manual and various other manuals is property of the BIXOLON Co., Ltd. Any copying or conversion into electronic form and saving of this material without the express written permission of BIXOLON Co., Ltd. is strictly prohibited.

Use of the information contained in this manual is not subject to any patent liability. This manual has been prepared with utmost care and attention to detail but may contain certain errors and/or omissions.

BIXOLON Co., Ltd. is not legally liable for any damages resulting from the use of the information in this manual.

BIXOLON Co., Ltd. and its affiliates are not legally liable (United States excluded) for any damages, loss, costs, and/or expenses that result from the breakdown, malfunction, and/or misuse of the product due to violation or neglect of the operation and maintenance information and instructions provided by the BIXOLON Co., Ltd., as well as from the unauthorized alteration, repair, and/or modification of the product by the user and/or third party.

BIXOLON Co., Ltd. is not legally liable for any damages and/or issues resulting from the use of options and/or parts that are not authentic BIXOLON products or authorized products.

1. Content Confirmation

The following items should all be contained in the printer package.
Contact the dealer from which the purchase was made if any item is damaged and/or missing.

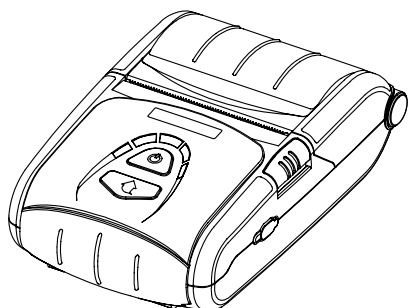

SPP-R200

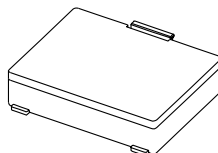

Battery

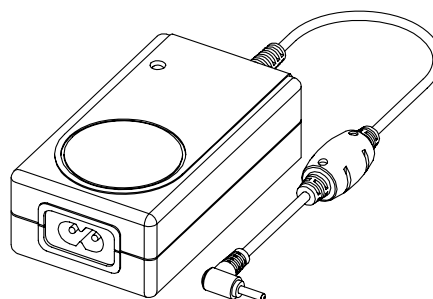

Battery Charger

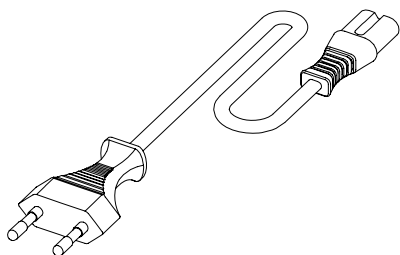

Power Cord

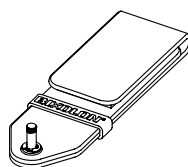

Belt Strap

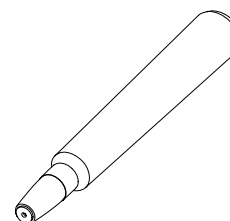

Cleaning Pen

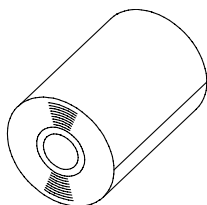

Paper

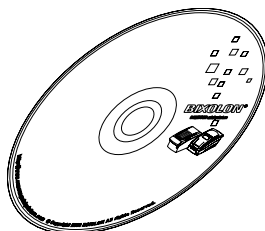

CD

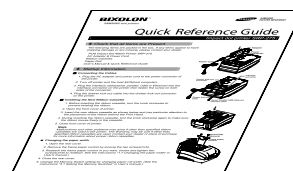

User Manual

※ Optional items

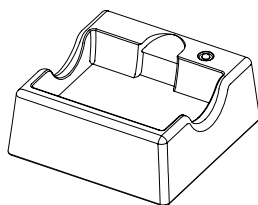

Battery Holder

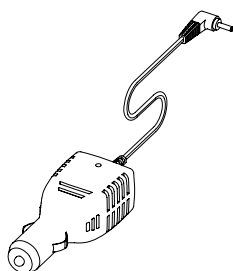

**Cigarette
Lighter Jack**

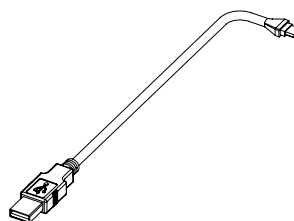

Interface Cable

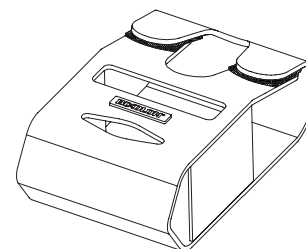

Leather Case

2. Product Part Names

- **Front**

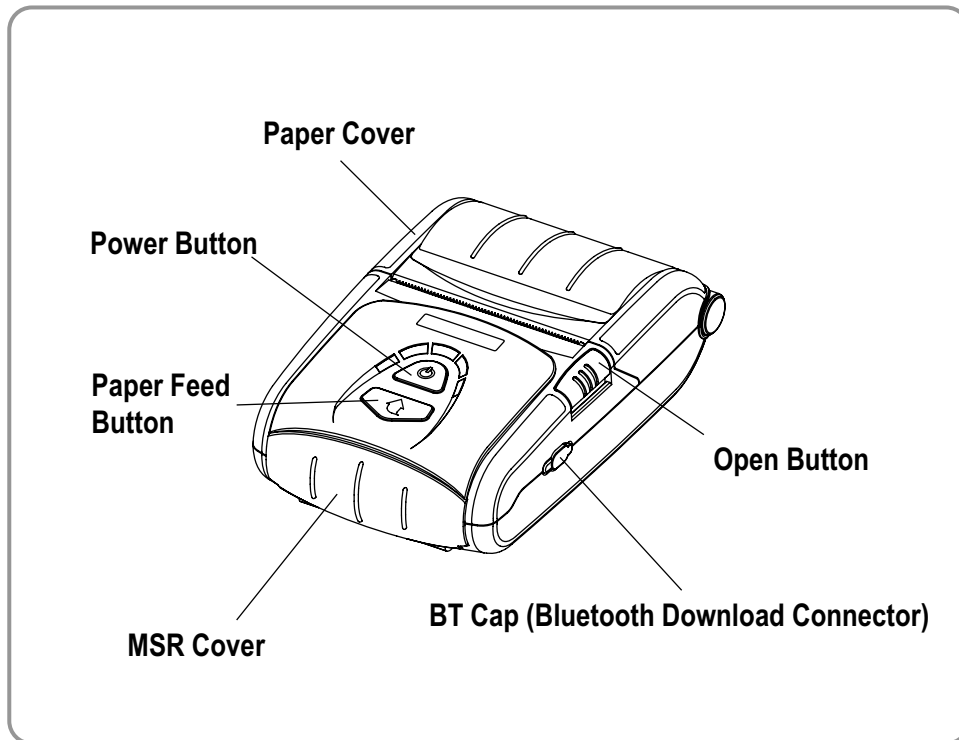

- **Rear**

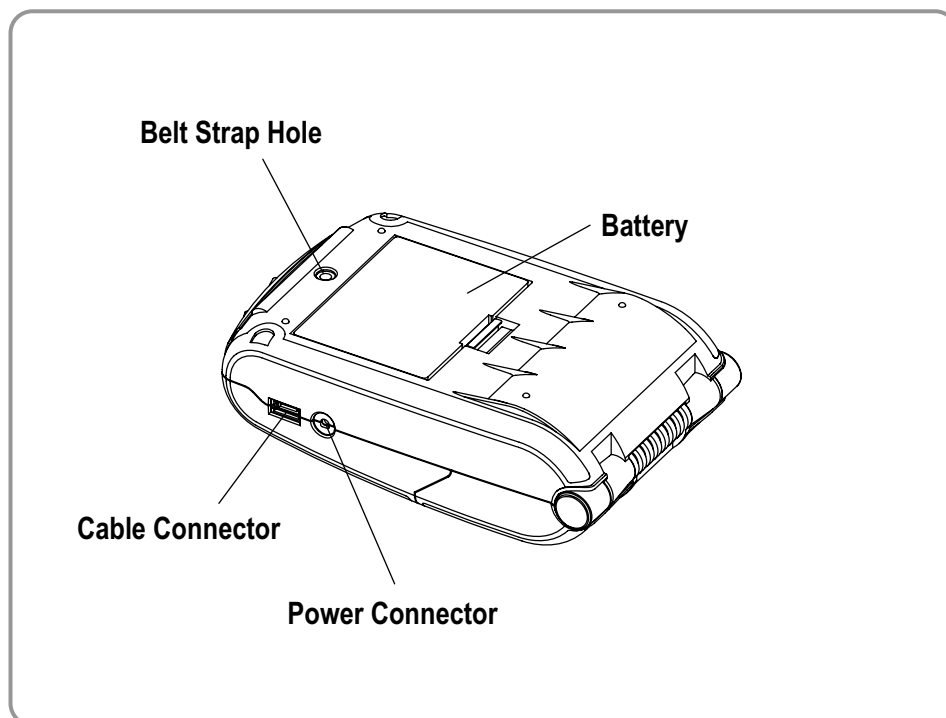

3. Installation & Usage

3-1 Battery Installation

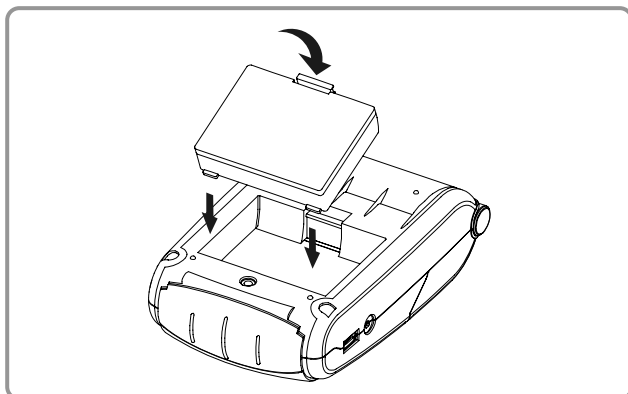

- 1) Insert the battery on the rear side of the printer, aligning the battery hook properly.
- 2) Push the battery into the slot until a snapping sound is heard.

 **NOTE**

As the battery is not charged at the time of purchase, charge the battery prior to product use.

(Use the battery charger and/or the optional battery holder.)

3-2 Battery Charging

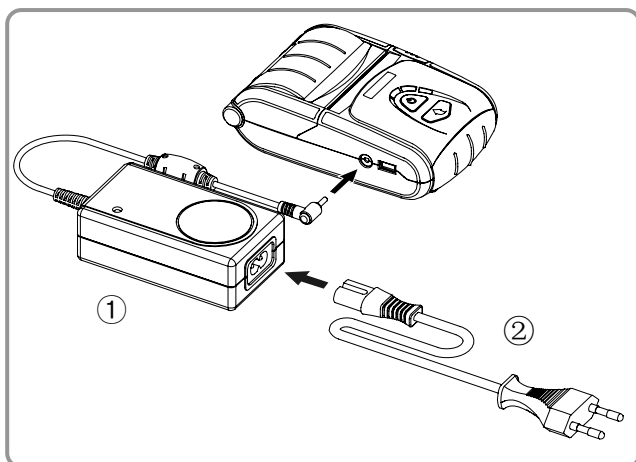

- 1) Turn off the printer power.
- 2) Connect the power cord (2) to the battery charger (1).
- 3) Connect the battery charger (1) to the power connector of the printer.
- 4) Plug the power cord (2) into an electrical outlet.

 **CAUTION**

The printer may incur serious damage if the battery charger provided by BIXOLON is not used. BIXOLON is not legally liable for any such damages. (The voltage and electrical current specifications of the printer and battery charger must match.)

3-3 Battery Holder (Optional) Usage

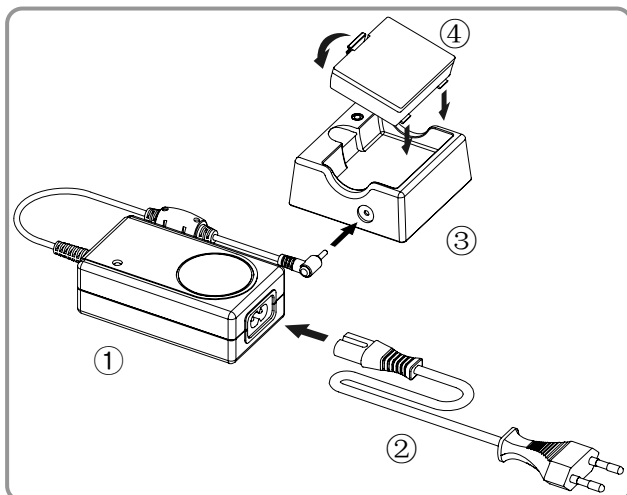

- 1) Connect the power cord② to the battery charger①.
- 2) Connect the battery charger① to the power connector of the battery holder③.
- 3) Plug the power cord② into an electrical outlet.
- 4) Insert the battery④ into the battery holder③ until a snapping sound is heard.

3-4 Cigarette Lighter Jack Charger (Optional) Usage

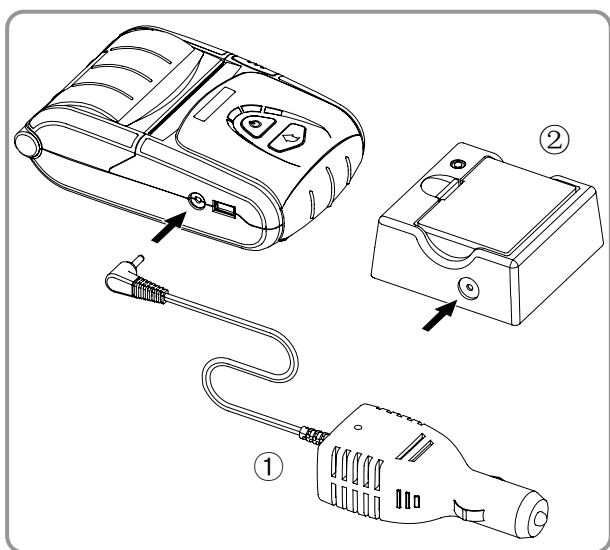

- 1) Connect the cigarette lighter jack charger① to the cigarette lighter jack of an automobile and/or the printer or battery holder② as shown in the image.

3-5 Paper Installation

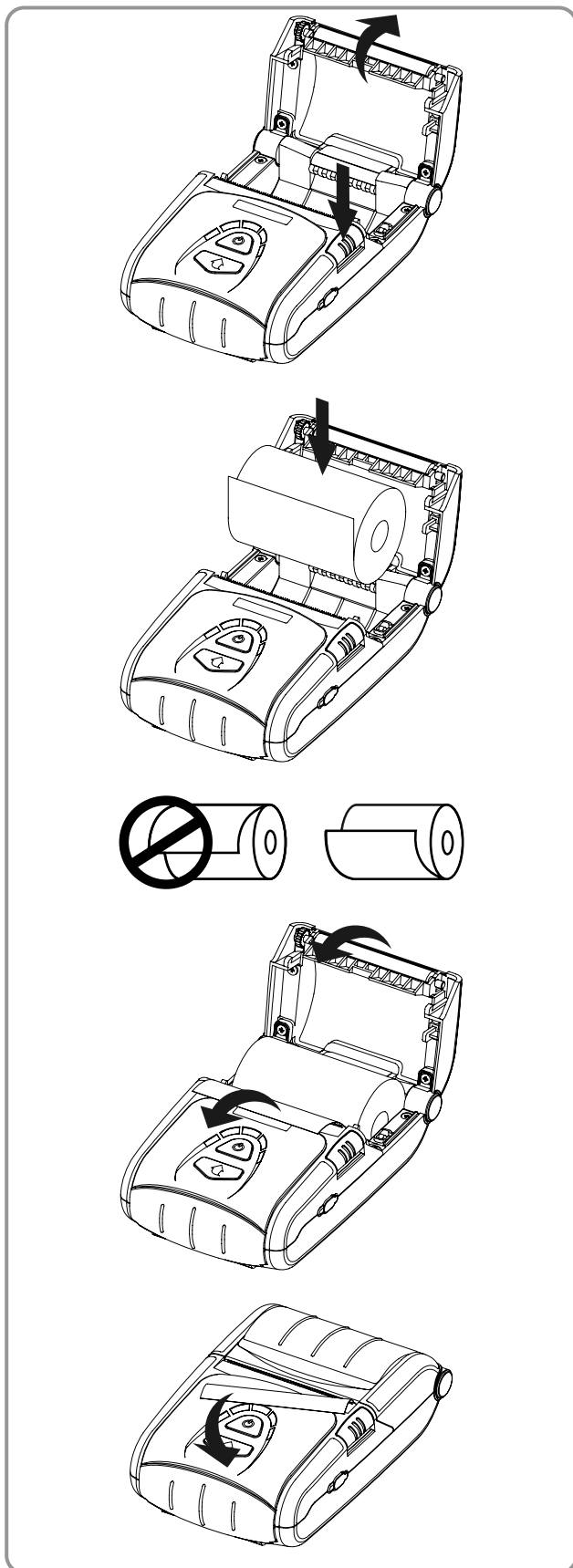

1) Press the Open button to open the paper cover.

2) Insert the paper as shown in the image. (Remove any remaining core of a fully used paper roll.)

3) Take care to align the paper correctly.

4) Pull the paper out as shown in the image and close the paper cover.

5) Tear off any excess paper in the direction of the side of the printer.

3-6 Belt Strap Usage

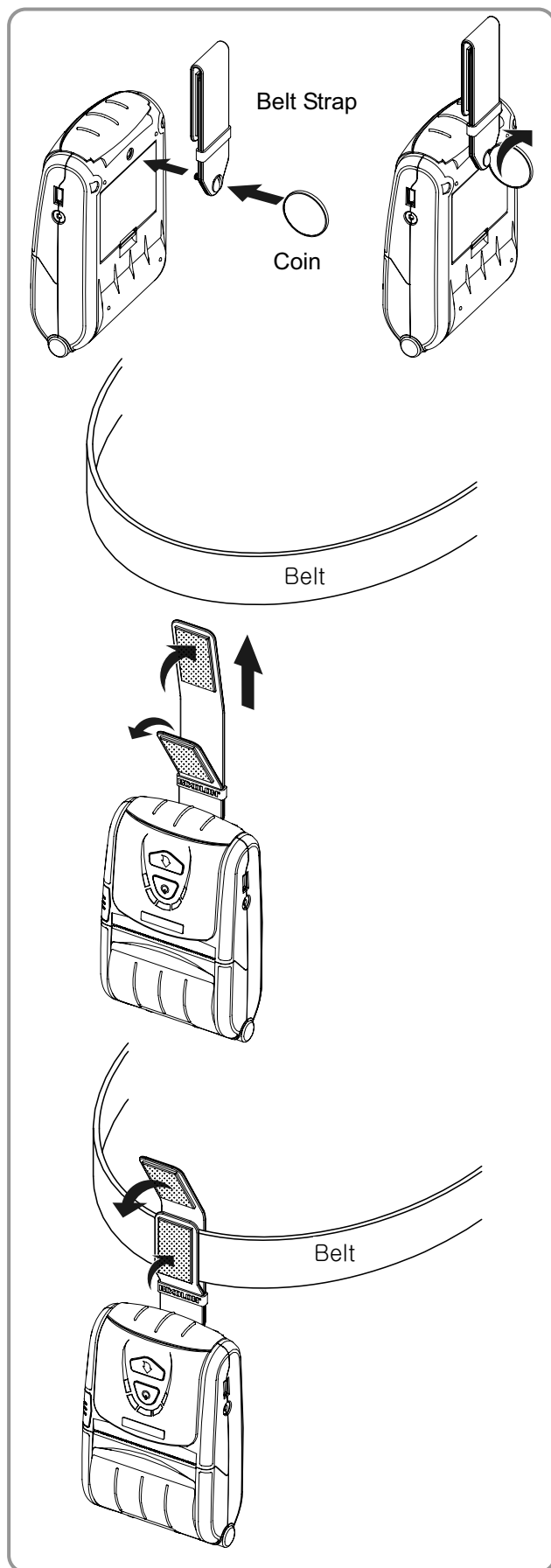

1) Insert the belt strap screw into the belt strap hole.

2) Use a coin to tighten the belt strap screw as shown in the image.

3) Undo the belt strap Velcro.

4) Fasten the belt strap to a belt.

5) Close the Velcro as shown in the image.

3-7 Leather Case (Optional) Usage

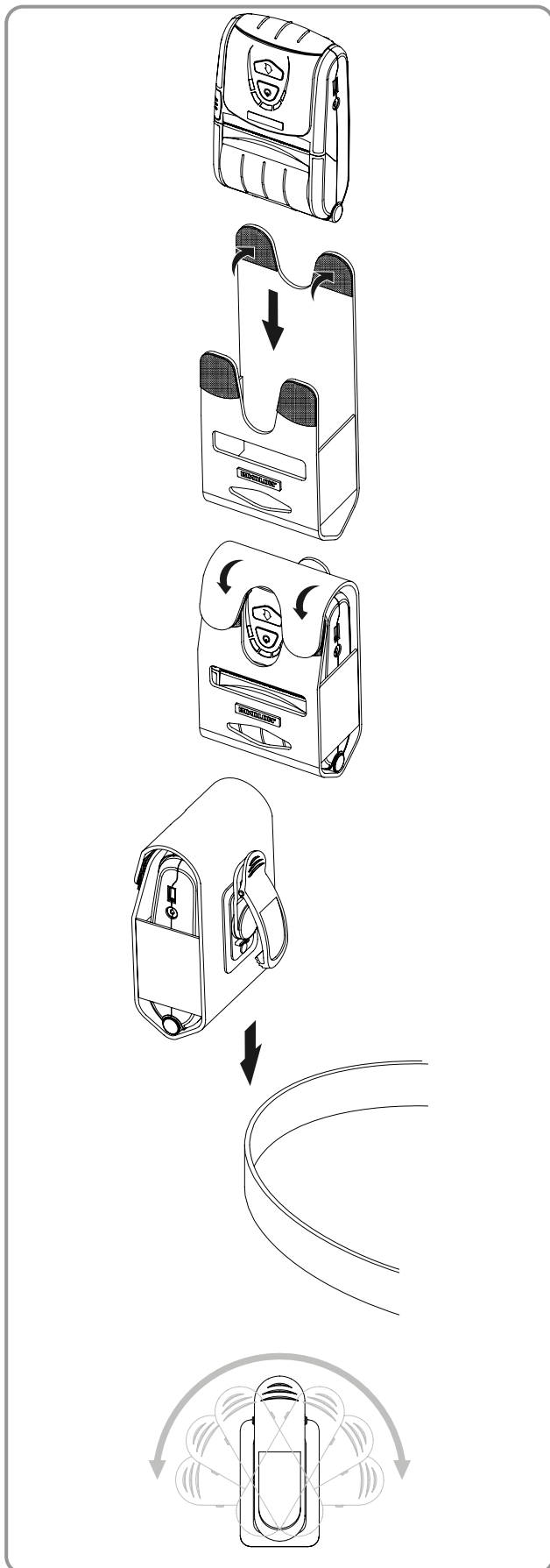

1) Undo the Velcro.

2) Place the printer into the leather case following the direction shown in the image.

3) Close the Velcro.

4) Affix to a belt using the clip at the rear of the case.

 **NOTE**

The clip on the leather case can be rotated three stages by 30° per stage (maximum 90°)

3-8 Control Panel Usage

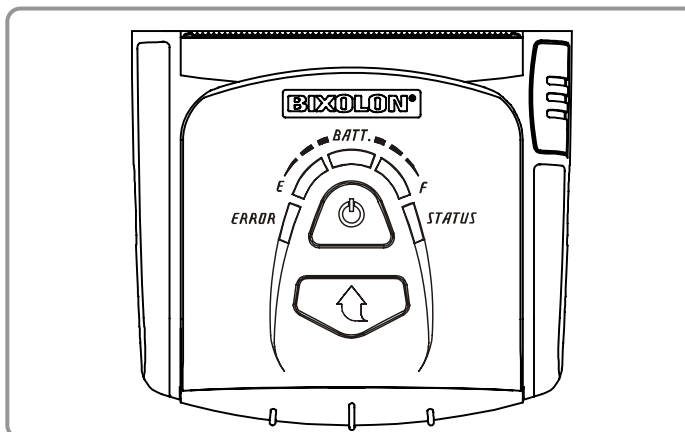

• **Power Button**

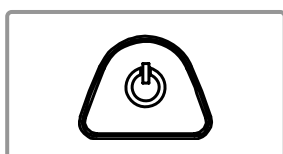

This button is used to turn the printer on and off. When the printer is off, pressing this button for approximately 2 seconds will turn the power on. When the printer is on, pressing this button for approximately 2 seconds will turn the power off.

• **Paper Feed Button**

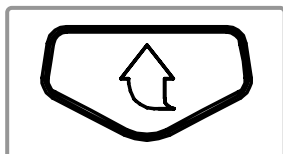

Paper output can be done manually by pressing this button. In addition, self-testing and Hexadecimal Dumping can be done.
 1) Refer to “4. Self-Test” for self-test information.
 2) Refer to the service manual regarding Hexadecimal Dumping.

• **Battery Status Lamp (Blue or Red)**

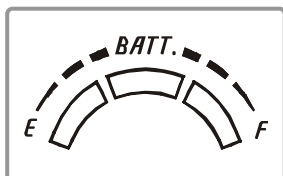

- 1) If three blue lamps are lit, the battery is fully charged.
- 2) If two blue lamps are lit, the battery is half charged.
- 3) If one blue lamp is lit, the battery is at the lowest charge level.
- 4) If the red lamp is lit, the battery must be charged or replaced.

• **Error Lamp (Red)**



- 1) If the red lamp is lit, the paper cover is open.
- 2) If the red lamp is blinking, either the paper has been fully used or the print head is overheated.
 (Fill with paper or turn the printer off for at least 10 minutes.)
- 3) If the red lamp continues to blink, it may indicate a more serious problem with the product, and thus an authorized service dealer should be consulted.

• **Bluetooth Lamp (Green)**

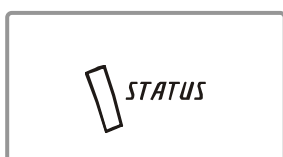

- 1) If the green lamp turns on in unison with the battery status lamp, the printer can be used with Bluetooth wireless communication.
- 2) If only the green lamp is lit, the printer has entered the power saving mode.

NOTE

The power saving mode is activated after the first communication, with the default time interval being 10 seconds.

3-9 MSR Usage

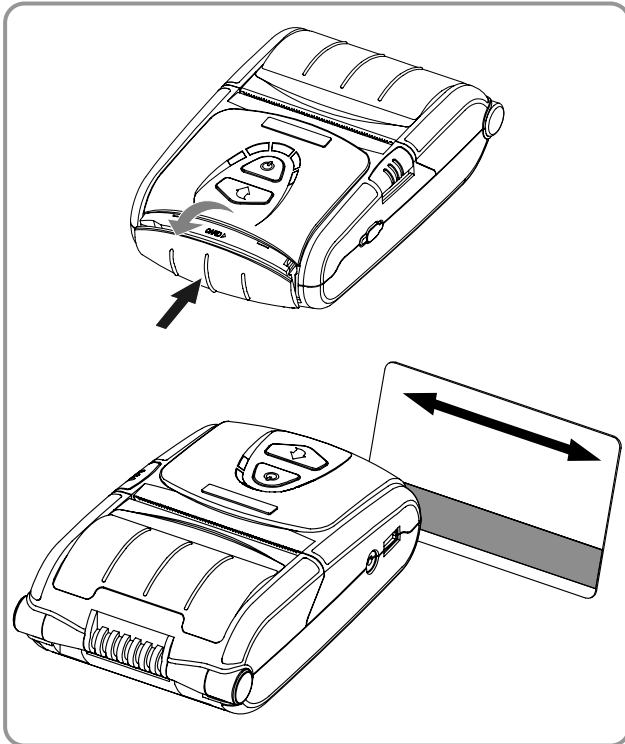

- 1) Press the MSR cover to open.
- 2) Insert the card as shown in the image and swipe in the direction of the arrow. (can be done in both directions)
- 3) When finished using, press the MSR cover to close it.

 **NOTE**

If the card does not register, first check to see if it is properly aligned. When swiping the card, the recommended swiping speed is 100 ~ 1500 mm/sec.

4. Self-Test

Run the self-test when first setting the printer or when encountering a problem, and check the following.

- Control Circuit, Mechanisms, Print Quality, ROM Version, and Memory Switch Settings

If no issue is found with the printer after running the self-test, examine the other devices or peripherals and software. This function is independent of such other devices and software.

• Self-Test Instructions

- 1) Turn the printer power off and close the printer paper cover.
- 2) Pressing the paper feed button and power button simultaneously turns the printer on.
- 3) The printout is produced after releasing the two buttons.
- 4) To add a printout of the ASCII pattern, press the paper feed button once more.
- 5) After the ASCII pattern is printed out, the self-test is automatically terminated.

5. Peripherals Connection

This product can communicate with other devices via Bluetooth communication and cable.

5-1 Bluetooth Connection

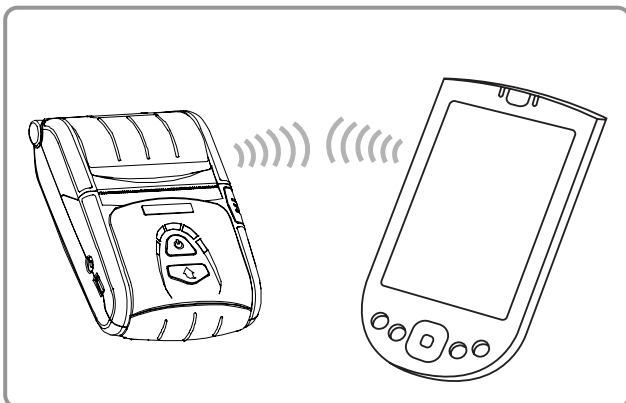

- 1) The printer can be connected to devices equipped with Bluetooth communication capacity (PDAs, PCs, etc.).
- 2) Use the Bluetooth connection function supported by the device to connect to the printer.

 **NOTE**

Refer to the Bluetooth Manual for more details on connection.

 **CAUTION**

The BT Cap(Bluetooth Download Connector) is only for Bluetooth program downloading. Any user other than an authorized service provider should not use this feature.

5-2 Interface Cable Connection

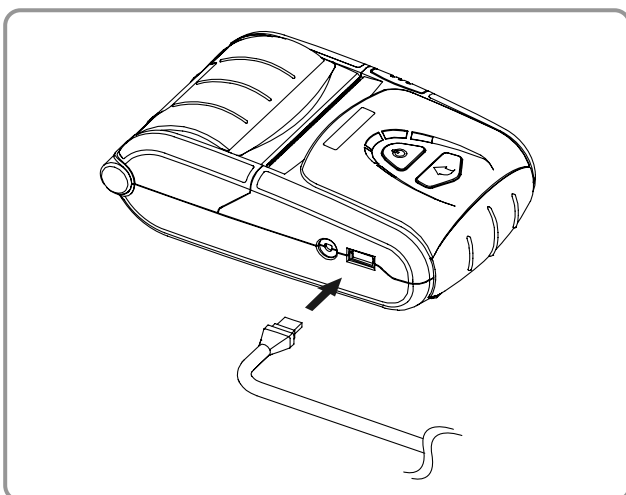

- 1) Connect the interface cable (optional) to the cable connector of the printer.

 **NOTE**

Use only cables (optional) provided by BIXOLON (USB, Serial).

- 2) Connect the interface cable to the USB port of the device (PDAs, PCs, etc.).

 **NOTE**

The interface cable that can be connected with the printer is available in both USB and Serial type.

Refer to the service manual for detailed interface cable specifications.

6. Printer Cleaning

If the interior of the printer is dusty, print quality can decline.
In such a case, follow the instructions below to clean the printer.

⚠ CAUTION

- Make sure to turn the printer power off prior to cleaning.
- As the print head gets very hot during printing, if intending to clean the print head, turn the printer power off and wait approximately 10 minute before commencement.
- When cleaning the print head, take care not to touch the heated portion of the print head.
 - The print head is susceptible to damage from static electricity, etc.
- Take care not to allow the print head to become scratched and/or damaged in any way.

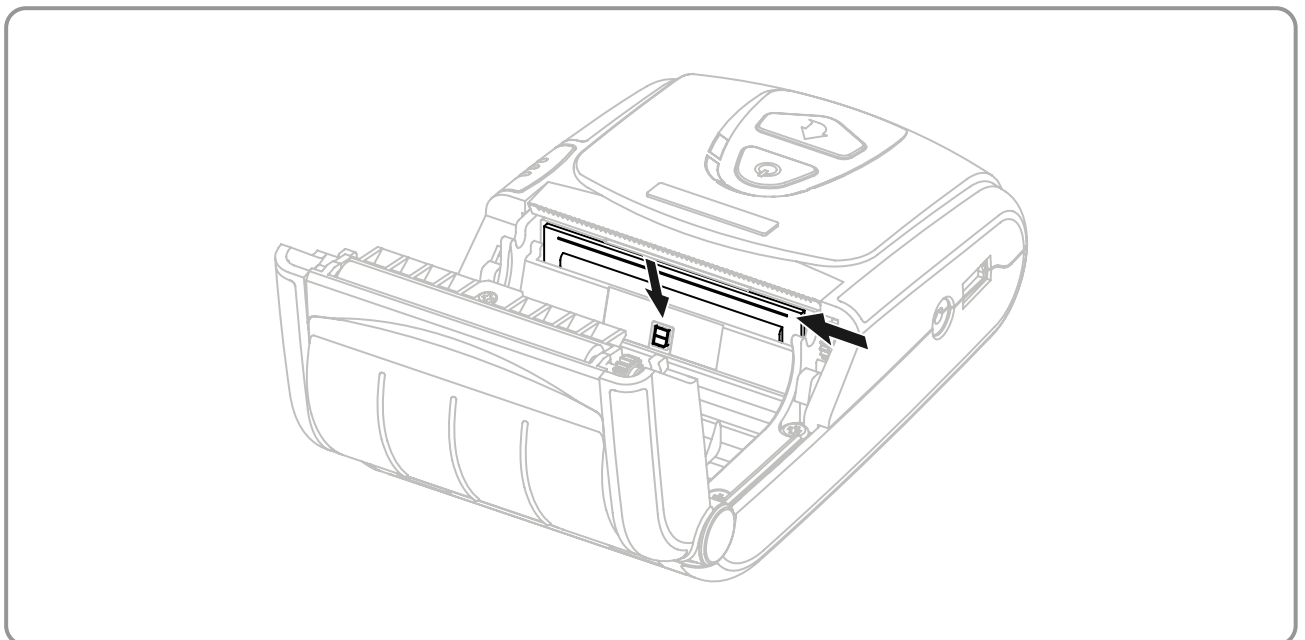

- 1) Open the paper cover and remove any paper that may be present.
- 2) Wipe the print head with a cleaning pen.
- 3) Use a cloth moistened with an alcohol solution to clean the paper sensor area and remove any paper remnants and/or dust.
- 4) Insert paper into the printer 1~2 minutes after completing the cleaning process and close the printer cover.

7. Appendix**7-1 Specifications**

Item	Description	
Printing	Printing Method	Thermal printing
	Printing Speed	80 mm/sec
	Resolution	203 DPI
	Paper Supply Mode	Easy paper loading
	Character Size	Font A: 12 × 24 Font B: 9 × 24
	Characters Per Line	Font A: 32 Font B: 42
	Character Set	English: 95 Expanded Graphics: 128 × 20 pages International: 32
	Barcode	1 Dimension: UPC A, UPC B, CODE 39, CODE 93, Code 128, EAN 8, EAN 13, EAN 18, ITF, Codabar 2 Dimension: PDF417
	Emulation	ESC/POS
	Driver	Windows, WinCE 4.2, WinCE 5.0
	Sensor	No Paper Sensor, Paper Cover Open Switch
	Cutter Type	Manual Cutter
	Language	User language supported
Paper	Paper Type	Thermal paper
	Width	58 ± 0.5 mm (2.28" ± 0.2")
	Diameter	Max. ø40 mm (1.57")
Reliability	TPH	50 km
	Battery	Rechargeable up to 500 times
Communications	Interface	Serial/USB, Bluetooth Class2 V1.2
Battery Charger	Input	Voltage: 100 ~ 250 VAC Current: 1.0A (Max. at 110VA)
	Output	Voltage: 8.4 VDC Current: 0.8A
Battery	Type	Lithium-ion
	Output	Voltage: 7.4 VDC (Available 8.4 ~ 6.8VDC) Capacity: 1200 mAh
	Charging Time	2.5 hours
Usage Conditions	Temperature	Printer: -10~50 °C (14~122 °F) Battery: 0~40 °C (32~104 °F)
	Humidity	Printer: 10~90% RH (No condensation) Battery: 20~70% RH (No condensation)
Dimensions	Printer	79.5mm × 126.7mm × 43.6mm (3.13" × 4.99" × 1.72")
Weight	Printer	Printer: 184g (0.41lbs) Printer + Battery: 236g (0.52lbs) Printer + Battery + Paper: 293g (0.65lbs) Package: approx. 680g (1.5lbs)
Accessories	Basic Package	Battery, Battery Charger, Belt Strap, Cleaning Pen
	Sold Separately	Battery, Battery Holder, Leather Case, Interface Cable, Cigarette Lighter Jack Charger

7-2 Certification

1) EMC & Safety Standards

- Europe: CE Mark: CE 0984, DEMKO GS: EN60950-1: 2001
- North America: FCC rules part 15C
- Safety Standards: CB-scheme: IEC60950-1: 2001

⚠ WARNING

Use of an unprotected interface cable with this printer conflicts with EMC standards. Users should only use cables approved by BIXOLON.

2) CE Mark

- | | |
|-----------------------------------|---|
| • EMC Directive 89/336/EEC | EN55002 Class B:1998+A1:2000
EN55024:1998+A1:2001
EN61000-3-2:2000
EN61000-3-3:1995+A1:2001
EN6100-4-2:1995+A1:1998+A2:2001
EN6100-4-3:1996+A1:1998+A2:2001
EN6100-4-4:1995+A1:2001
EN6100-4-5:1995+A1:2001
EN6100-4-6:1996+A1:2001
EN6100-4-8:1993+A1:2001
EN6100-4-11:1994+A1:2001
EN310489-17 v1.2.1
EN300328 v1.6.1 |
| • Radio Spectrum | Safety: EN60950-1:2001 |
| • Low Voltage Directive 73/23/EEC | |

3) WEEE (Waste Electrical and Electric Equipment)



This mark shown on the product or its literature indicates that the corresponding item should not be discarded at the end of its working life with other household waste. To prevent possible harm to the environment or human health from uncontrolled waste disposal, please separate marked items from other types of waste and recycle them responsibly to promote the sustained reuse of material resources. Household users should contact either the retailer where they purchased this product, or their local government office for details of where and how they can conduct environmentally safe recycling of such items. Commercial users should contact their suppliers and check the terms and conditions of purchase contracts. This product should not be combined with other commercial waste for disposal.

7-3 Label Types

The label types used with this printer is as follows.

- BIXOLON Logo Labels: PC
- Rating Labels: PP
- Other Labels: PET