

3200



Linear Imager

Disclaimer

Hand Held Products, Inc. ("Hand Held Products") reserves the right to make changes in specifications and other information contained in this document without prior notice, and the reader should in all cases consult Hand Held Products to determine whether any such changes have been made. The information in this publication does not represent a commitment on the part of Hand Held Products.

Hand Held Products shall not be liable for technical or editorial errors or omissions contained herein; nor for incidental or consequential damages resulting from the furnishing, performance, or use of this material.

This document contains proprietary information that is protected by copyright. All rights are reserved. No part of this document may be photocopied, reproduced, or translated into another language without the prior written consent of Hand Held Products.

©2008 Hand Held Products, Inc. All rights reserved.

Web Address: www.handheld.com



Table of Contents

Chapter 1 - Getting Started

About This Manual	1-1
Unpacking the Imager.....	1-1
3200 Models	1-1
Connecting the Imager with USB	1-2
USB PC or Macintosh Keyboard	1-2
Plug and Play	1-3
Connecting the Imager When Powered by Host (Keyboard Wedge).....	1-3
Keyboard Wedge Connection	1-4
Laptop Direct Connect	1-4
Connecting the Imager with RS-232 Serial Port.....	1-4
Reading Techniques	1-6
Resetting the Standard Product Defaults	1-6

Chapter 2 - Terminal Interfaces

Terminal ID	2-1
Supported Terminals.....	2-2
Keyboard Country	2-3
Keyboard Style	2-4
Keyboard Modifiers.....	2-4
RS-232 Baud Rate.....	2-6
RS-232 Word Length: Data Bits, Stop Bits, and Parity ..	2-7
RS-232 Handshaking	2-8

Chapter 3 - Output

Good Read Indicators	3-1
Beeper – Good Read	3-1
Beeper Pitch – Good Read	3-1
Trigger Modes	3-1
Manual/Serial Trigger	3-1
Trigger	3-1
Automatic Trigger.....	3-2

Reread Delay	3-2
--------------------	-----

Chapter 4 - Data Editing

Prefix/Suffix Overview.....	4-1
To Clear One or All Prefixes or Suffixes:.....	4-3
To Add a Carriage Return Suffix to all Symbologies	4-3
Prefix Selections.....	4-3
Suffix Selections	4-4
Function Code Transmit.....	4-4
Intercharacter, Interfunction, and Intermesssage Delays	4-4
Intercharacter Delay	4-5
Interfunction Delay	4-5
Intermesssage Delay	4-6

Chapter 5 - Data Formatting

Data Format Editor Introduction	5-1
To Add a Data Format.....	5-1
Other Programming Selections	5-2
Data Format Editor Commands	5-2
Data Format Editor.....	5-3
Data Formatter	5-4

Chapter 6 - Symbologies

Introduction.....	6-1
Message Length.....	6-1
Codabar.....	6-2
Codabar Start/Stop Characters	6-2
Codabar Check Character	6-2
Codabar Message Length.....	6-3
Code 39.....	6-4
Code 39 Start/Stop Characters.....	6-4
Code 39 Check Character.....	6-5
Code 39 Message Length	6-5
Full ASCII.....	6-6
Code 39 Code Page	6-7

Interleaved 2 of 5	6-7
Check Digit.....	6-7
Interleaved 2 of 5 Message Length	6-8
Code 93	6-9
Code 93 Message Length	6-9
Code 93 Code Page	6-9
Straight 2 of 5 Industrial	6-10
Straight 2 of 5 Industrial Message Length	6-10
Straight 2 of 5 IATA Message Length	6-11
Matrix 2 of 5	6-11
Matrix 2 of 5 Message Length	6-12
Code 11	6-12
Check Digits Required	6-12
Code 11 Message Length	6-13
Code 128	6-13
ISBT 128 Concatenation	6-13
Code 128 Message Length	6-14
Code 128 Code Page	6-14
Code 128 Function Code Transmit	6-14
Telepen.....	6-15
Telepen Output	6-15
Telepen Message Length.....	6-15
UPC A.....	6-16
UPC A Check Digit.....	6-16
UPC A Number System	6-16
UPC A Addenda.....	6-16
UPC A Addenda Required	6-17
UPC E0 and UPC E1	6-18
UPC E0 and UPC E1 Expand.....	6-18
UPC E0 and UPC E1 Addenda Required.....	6-19
UPC E0 Check Digit	6-19
UPC E0 Number System.....	6-19
UPC E0 Addenda	6-20

EAN/JAN 13.....	6-20
EAN/JAN 13 Check Digit.....	6-20
EAN/JAN 13 Addenda.....	6-20
EAN/JAN 13 Addenda Required.....	6-21
EAN/JAN 13 Addenda Separator.....	6-21
ISBN Translate.....	6-22
EAN/JAN 8.....	6-22
EAN/JAN 8 Check Digit.....	6-22
EAN/JAN 8 Addenda.....	6-22
EAN/JAN 8 Addenda Required.....	6-23
EAN/JAN 8 Addenda Separator.....	6-23
MSI.....	6-24
MSI Check Character.....	6-24
MSI Message Length.....	6-25
Plessey Code.....	6-25
Plessey Message Length.....	6-25
RSS Limited.....	6-26
RSS Expanded.....	6-27
RSS Expanded Message Length.....	6-27
China Post Code.....	6-28

Chapter 7 - Interface Keys

Keyboard Function Relationships.....	7-1
Supported Interface Keys.....	7-3

Chapter 8 - Utilities

To Add a Test Code I.D. Prefix to All Symbologies.....	8-1
Show Software Revision.....	8-1
Show Data Format.....	8-1
Resetting the Standard Product Defaults.....	8-1

Chapter 9 - Default Chart

Resetting the Standard Product Defaults.....	9-1
Menu Commands.....	9-1

Chapter 10 - Product Specifications

3200 Product Specifications	10-1
-----------------------------------	------

Chapter 11 - Maintenance

Repairs	11-1
Maintenance	11-1
Cleaning the Device	11-1
Inspecting Cords and Connectors	11-1
Replacing the Interface Cable	11-2
Troubleshooting	11-2

Chapter 12 - Customer Support

Technical Assistance	12-1
Online Technical Assistance	12-2
For Further Information	12-2
Product Service and Repair	12-2
Online Product Service and Repair Assistance	12-3
Limited Warranty	12-3

Appendix A

Symbology Chart	A-1
ASCII Conversion Chart (Code Page 1252)	A-2
Code Page Mapping of Printed barcodes	A-4

Sample Symbols



3200 Imager Identification

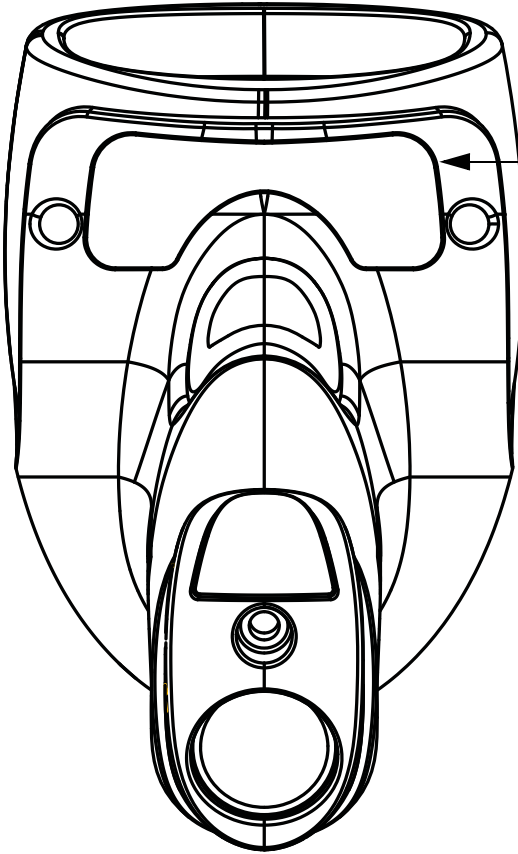

Item Number,
Serial Number and
Compliance
Information
location



Getting Started

About This Manual

This User's Guide provides installation and programming instructions for the 3200. Product specifications, dimensions, warranty, and customer support information are also included.

Hand Held Products barcode imagers are factory programmed for the most common terminal and communications settings. If you need to change these settings, programming is accomplished by scanning the barcodes in this guide.

An asterisk (*) next to an option indicates the default setting.

Unpacking the Imager

After you open the shipping carton containing the 3200, take the following steps:

- Check to make sure everything you ordered is present.
- Save the shipping container for later storage or shipping.
- Check for damage during shipment. Report damage immediately to the carrier who delivered the carton.

3200 Models

Note: The Hand Held Products 3200 imager may be used with two interfaces, which are described in this User's Guide. Refer to the chart below to determine the models that can be used with your interface.

The chart below lists the 3200 imager models. "04" designates ivory and "14" designates black.

Models	Primary Interfaces
3200-04USBE (ivory) 3200-14USBE (black)	USB
3200-04KBWE (ivory) 3200-14KBWE (black)	Keyboard wedge

Connecting the Imager with USB

Note: Hand Held Products recommends connecting the imager end of the cable first and the host end second.

An imager can be connected to the USB port of a computer.

1. Connect the appropriate interface cable to the imager and to the computer.

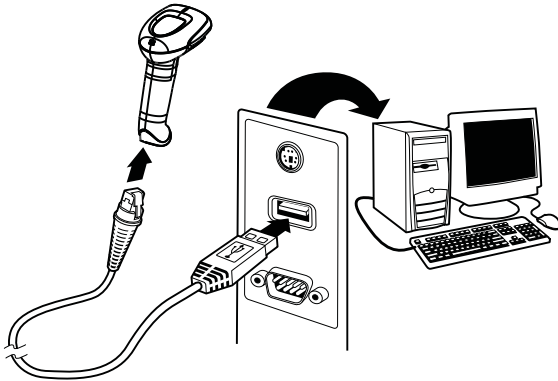

2. The imager beeps.
3. Verify the imager operation by scanning a barcode from the [Sample Symbols](#) in the back of this manual.

For additional USB programming and technical information, refer to the Hand Held Products “USB Application Note,” available at www.handheld.com.

USB PC or Macintosh Keyboard

The 3200 imagers are factory programmed for a USB interface. If this is your interface and you do not need to modify the settings, skip to [Chapter 3](#).

If you programmed the imager for a different terminal interface and you want to change to a USB Keyboard (PC) or USB Keyboard (Mac), scan one of the following codes to program the 3200. Scanning these codes adds a CR and selects the terminal ID (USB PC Keyboard - 124, USB Macintosh Keyboard - 125).



USB Keyboard (PC)



USB Keyboard (Mac)

Plug and Play

Plug and Play barcodes provide instant imager set up for commonly used interfaces.

Note: After you scan one of the codes, power cycle the host terminal to have the interface in effect.

Connecting the Imager When Powered by Host (Keyboard Wedge)

An imager can be connected between the keyboard and PC as a “keyboard wedge,” plugged into the serial port or connected to a portable data terminal. The following is an example of a keyboard wedge connection:

1. Turn off power to the terminal/computer.
2. Disconnect the keyboard cable from the back of the terminal/computer.
3. Connect the appropriate interface cable to the imager and to the terminal/computer.

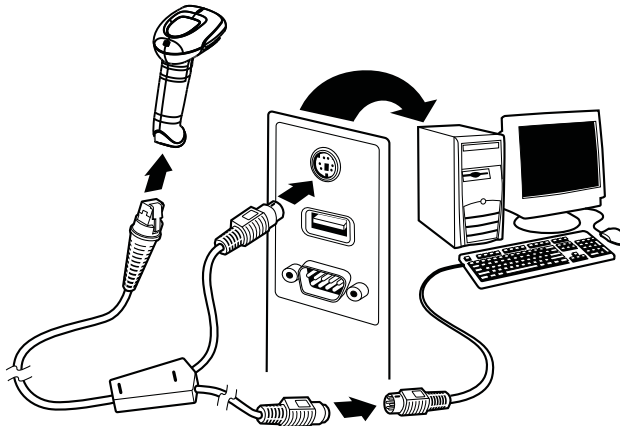

4. Turn the terminal/computer power back on.

Note: You will not hear a power-up beep because the 3200 is factory defaulted to a USB connection. You must scan the [IBM PC AT and Compatibles with CR suffix barcode on page 1-4](#) to enable keyboard wedge ability.

Verify the imager operation by scanning a barcode from the [Sample Symbols](#) in the back of this manual. The imager beeps once.

Keyboard Wedge Connection

Scanning the barcode below allows operation of the 3200 as a keyboard wedge interface to an IBM PC AT with a U. S. keyboard.

If you programmed the imager for a different terminal interface and you want to change to an IBM PC AT and compatibles keyboard wedge interface, scan the barcode below.

Note: The following barcode also programs a carriage return (CR) suffix.



IBM PC AT and Compatibles
with CR suffix

Laptop Direct Connect

For most laptops, scanning the **Laptop Direct Connect** barcode allows operation of the imager in parallel with the integral keyboard. The following Laptop Direct Connect barcode selects terminal ID 03, programs a carriage return (CR) suffix and turns on Emulate External Keyboard ([page 2-4](#)).



Laptop Direct Connect
with CR suffix

Connecting the Imager with RS-232 Serial Port

1. Turn off power to the terminal/computer.
2. Connect the appropriate interface cable to the imager.

Note: For the imager to work properly, you must have the correct cable for your type of terminal/computer.

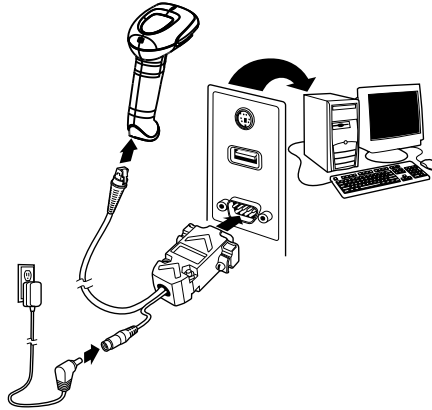

3. Plug the serial connector into the serial port on your computer. Tighten the two screws to secure the connector to the port.
4. Connect the power supply and plug into an outlet.
5. Turn the terminal/computer power back on.

Note: You will not hear a power-up beep because the 3200 is factory defaulted to a USB connection. You must scan the [RS-232 Interface](#) barcode below to enable RS-232 ability.

All communication parameters between the imager and terminal must match for correct data transfer through the serial port using RS-232 protocol. Scanning the RS-232 interface barcode, programs the imager for an RS-232 interface at 38,400 baud, parity–none, 8 data bits, 1 stop bit, and adds a suffix of a CR LF.



RS-232 Interface

Refer to [page 2-6](#) for additional RS-232 configuration settings.

Reading Techniques

The imager has a bright red aiming beam that corresponds to its horizontal field of view. The aiming beam should be centered horizontally over the barcode; it will not read if the aiming beam is in any other direction.

Good Technique



Bad Technique

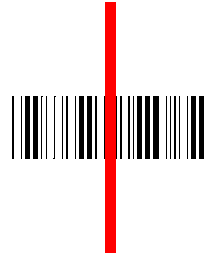

Bad Technique



The best focus point for reading most code densities is about 5 inches (12.7 cm) from the unit. To read a single barcode or multiple barcodes (on a page or on an object), hold the imager at an appropriate distance from the target, pull the trigger, and center the aiming beam on the barcode.

Resetting the Standard Product Defaults

If you aren't sure what programming options are in your imager, or you've changed some options and want the factory settings restored, scan the **Standard Product Default Settings** barcode below.



Standard Product Default Settings

The [Menu Commands](#) starting on [page 9-1](#) lists the factory default settings for each of the commands (indicated by an asterisk (*) on the programming pages).

Terminal Interfaces

Terminal ID

If your interface is not a standard PC AT, refer to [Terminal ID](#), beginning on page 2-1 and locate the Terminal ID number for your PC. Scan the **Terminal ID** barcode below, then scan the numeric barcode(s) from the [Programming Chart](#) inside the back cover of this manual to program the imager for your terminal ID. Scan **Save** to save your selection.

For example, an IBM AT terminal has a Terminal ID of 003. You would scan the **Terminal ID** barcode, then **0, 0, 3** from the [Programming Chart](#) inside the back cover of this manual, then **Save**. If you make an error while scanning the digits (before scanning Save), scan the **Discard** code on the [Programming Chart](#), scan the **Terminal ID** barcode, scan the digits, and the **Save** code again.



Terminal ID



Save

Note: After scanning one of these codes, you must power cycle your computer.

Supported Terminals

<u>Terminal</u>	<u>Model(s)</u>	<u>Terminal ID</u>
RS-232 TTL		000
USB PC Keyboard		124 *
USB Mac Keyboard		125

* Factory default

Keyboard Country

Scan the appropriate country code below to program the keyboard for your country. As a general rule, the following characters are supported, but need special care for countries other than the United States:

@ | \$ # { } [] = / ' \ < > ~



* United States



Belgium



Denmark



Finland



France



Germany/Austria



Great Britain



Italy



Norway



Spain



Switzerland

Please refer to Hand Held Products website (www.handheld.com) for complete keyboard country support information and applicable interfaces. If you need to program a keyboard for a country other than one listed above, scan the **Program Keyboard Country** barcode below, then scan the numeric barcode(s) for the appropriate country from the inside back cover, then the **Save** barcode.



Program Keyboard Country

Keyboard Style

This programs keyboard styles, such as Caps Lock and Shift Lock. *Default = Regular.*

Regular is used when you normally have the Caps Lock key off.



* Regular

Caps Lock is used when you normally have the Caps Lock key on.



Caps Lock

Autocaps via NumLock barcode should be scanned in countries (e.g., Germany, France) where the Caps Lock key cannot be used to toggle Caps Lock. The NumLock option works similarly to the regular Autocaps, but uses the NumLock key to retrieve the current state of the Caps Lock.



Autocaps via NumLock

Emulate External Keyboard should be scanned if you do not have an external keyboard (IBM AT or equivalent).



Emulate External Keyboard

Note: After scanning the Emulate External Keyboard barcode, you must power cycle your computer.

Keyboard Modifiers

This modifies special keyboard features, such as CTRL+ ASCII codes and Turbo Mode.

Control + ASCII Mode On: The imager sends key combinations for ASCII control characters for values 00-1F. Refer to [Keyboard Function Relationships](#), page 7-1 for CTRL+ ASCII Values. *Default = Off*



Control + ASCII Mode On



* Control + ASCII Mode Off

Numeric Keypad Mode: Sends numeric characters as if entered from a numeric keypad. *Default = Off*



Numeric Keypad Mode On



* Numeric Keypad Mode Off

Automatic Direct Connect Mode: This selection can be used if you have an IBM AT style terminal and the system is dropping characters. *Default = Off*



Automatic Direct
Connect Mode On



* Automatic Direct Connect
Mode Off

RS-232 Baud Rate

Baud Rate sends the data from the imager to the terminal at the specified rate. The host terminal must be set for the same baud rate as the imager.
Default = 38,400.



300



1200



4800



19200



57,600



600



2400



9600



* 38400

RS-232 Word Length: Data Bits, Stop Bits, and Parity

Data Bits sets the word length at 7 or 8 bits of data per character. If an application requires only ASCII Hex characters 0 through 7F decimal (text, digits, and punctuation), select 7 data bits. For applications which require use of the full ASCII set, select 8 data bits per character. *Default = 8.*

Stop Bits sets the stop bits at 1 or 2. *Default = 1.*

Parity provides a means of checking character bit patterns for validity. *Default = None.*



7 Data, 1 Stop, Parity Even



7 Data, 1 Stop, Parity Odd



7 Data, 2 Stop Parity None



8 Data, 1 Stop, Parity Even



8 Data, 1 Stop, Parity Odd



7 Data, 1 Stop, Parity None



7 Data, 2 Stop, Parity Even



7 Data, 2 Stop, Parity Odd



* 8 Data, 1 Stop, Parity None

RS-232 Handshaking

RS-232 handshaking is a set of rules concerning the exchange of data between serially communicating devices. *Default = RTS/CTS, XON/XOFF and ACK/NAK Off.*



RTS/CTS On



XON/XOFF On



ACK/NAK On



* RTS/CTS Off



* XON/OFF Off



* ACK/NAK Off

Good Read Indicators

Beeper – Good Read

The beeper may be programmed On or Off in response to a good read. Turning this option off, only turns off the beeper response to a good read indication. All error and menu beeps are still audible. *Default = On.*



* On



Off

Beeper Pitch – Good Read

The beeper pitch codes modify the pitch (frequency) of the beep the imager emits on a good read. *Default = Medium.*



Low (1600 Hz)



* Medium (2550 Hz)



High (4200 Hz)

Trigger Modes

Manual/Serial Trigger

Trigger

The following barcodes will allow you to use the reader in Manual Trigger mode (need to press the trigger to read) or Automatic Trigger mode (the beam is always on).



* Manual/Serial Trigger

Automatic Trigger

The imager scans continuously at full power with illumination fully on.



Automatic Trigger

Reread Delay

This sets the time period before the imager can read the *same* barcode a second time. Setting a reread delay protects against accidental rereads of the same barcode. Longer delays are effective in minimizing accidental rereads at POS (point of sale). Use shorter delays in applications where repetitive barcode scanning is required. *Default = Medium.*

Reread Delay only works when in automatic trigger mode or presentation mode (see [page 3-2](#)).



Short (500 ms)



* Medium (750 ms)



Long (1000 ms)



Extra Long (2000 ms)

Prefix/Suffix Overview

When a barcode is scanned, additional information is sent to the host computer along with the barcode data. This group of barcode data and additional, user-defined data is called a “message string.” The selections in this section are used to build the user-defined data into the message string.

Prefix and Suffix characters are data characters that can be sent before and after scanned data. You can specify if they should be sent with all symbologies, or only with specific symbologies. The following illustration shows the breakdown of a message string:

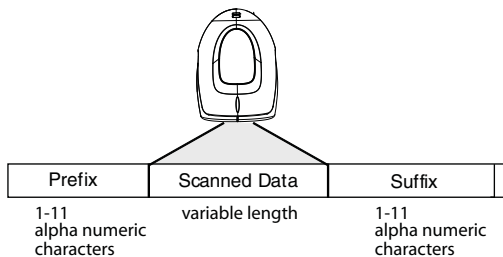

Points to Keep In Mind

- It is not necessary to build a message string. The selections in this chapter are only used if you wish to alter the default settings. *Default prefix = None. Default suffix = None.*
- A prefix or suffix may be added or cleared from one symbology or all symbologies.
- You can add any prefix or suffix from the [ASCII Conversion Chart \(Code Page 1252\)](#) on page A-2, plus Code I.D. and AIM I.D.
- You can string together several entries for several symbologies at one time.
- Enter prefixes and suffixes in the order in which you want them to appear on the output.

To Add a Prefix or Suffix:

- Step 1.** Scan the **Add Prefix** or **Add Suffix** symbol (page 4-3).
- Step 2.** Determine the 2 digit Hex value from the Symbology Chart (included in the [Appendix A](#)) for the symbology to which you want to apply the prefix or suffix. For example, for Code 128, Code ID is “j” and Hex ID is “6A”.
- Step 3.** Scan the 2 hex digits from the [Programming Chart](#) inside the back cover of this manual or scan **9, 9** for all symbologies.
- Step 4.** Determine the hex value from the [ASCII Conversion Chart \(Code Page 1252\)](#) on page A-2, for the prefix or suffix you wish to enter.
- Step 5.** Scan the 2 digit hex value from the [Programming Chart](#) inside the back cover of this manual.
- Step 6.** Repeat Steps 4 and 5 for every prefix or suffix character.
- Step 7.** To add the Code I.D., scan **5, C, 8, 0**.
To add AIM I.D., scan **5, C, 8, 1**.
To add a backslash (\), scan **5, C, 5, C**.

Note: To add a backslash (\) as in Step 7, you must scan 5C twice – once to create the leading backslash and then to create the backslash itself.

- Step 8.** Scan **Save** to exit and save, or scan **Discard** to exit without saving.
Repeat Steps 1-6 to add a prefix or suffix for another symbology.

Example: Add a Suffix to a specific symbology

To send a CR (carriage return) Suffix for UPC only:

- Step 1.** Scan **Add Suffix**.
- Step 2.** Determine the 2 digit hex value from the Symbology Chart (included in the [Appendix A](#)) for UPC.
- Step 3.** Scan **6, 3** from the [Programming Chart](#) inside the back cover of this manual.
- Step 4.** Determine the hex value from the [ASCII Conversion Chart \(Code Page 1252\)](#) on page A-2, for the CR (carriage return).
- Step 5.** Scan **0, D** from the [Programming Chart](#) inside the back cover of this manual.
- Step 6.** Scan **Save**, or scan **Discard** to exit without saving.

To Clear One or All Prefixes or Suffixes:

You can clear a single prefix or suffix, or clear all prefixes/suffixes for a symbology. When you Clear One Prefix (Suffix), the specific character you select is deleted from the symbology you want. When you Clear All Prefixes (Suffixes), all the prefixes or suffixes for a symbology are deleted.

Step 1. Scan the **Clear One Prefix** or **Clear One Suffix** symbol.

Step 2. Determine the 2 digit Hex value from the Symbology Chart (included in the [Appendix A](#)) for the symbology from which you want to clear the prefix or suffix.

Step 3. Scan the 2 digit hex value from the [Programming Chart](#) inside the back cover of this manual or scan **9, 9** for all symbologies.

Your change is automatically saved.

To Add a Carriage Return Suffix to all Symbologies

Scan the following barcode if you wish to add a carriage return suffix to all symbologies at once. This action first clears all current suffixes, then programs a carriage return suffix for all symbologies.



Add CR Suffix
All Symbologies

Prefix Selections



Add Prefix



Clear One Prefix



Clear All Prefixes

Suffix Selections



Add Suffix



Clear One Suffix



Clear All Suffixes

Function Code Transmit

When this selection is enabled and function codes are contained within the scanned data, the imager transmits the function code to the terminal. Charts of these function codes are provided in [Supported Interface Keys](#) starting on [page 7-3](#). When the imager is in keyboard wedge mode, the scan code is converted to a key code before it is transmitted. *Default = Enable.*



* Enable



Disable

Intercharacter, Interfunction, and Intermesssage Delays

Some terminals drop information (characters) if data comes through too quickly. Intercharacter, interfunction, and intermessage delays slow the transmission of data, increasing data integrity.

Each delay is composed of a 5 millisecond step. You can program up to 99 steps (of 5 ms each) for a range of 0-495 ms.

Intercharacter Delay

An intercharacter delay of up to 495 milliseconds may be placed between the transmission of each character of scanned data. Scan the **Intercharacter Delay** barcode below, then scan the number of milliseconds and the **SAVE** barcode using the [Programming Chart](#) inside the back cover of this manual.



To remove this delay, scan the **Intercharacter Delay** barcode, then set the number of steps to 0. Scan the **SAVE** barcode using the [Programming Chart](#) inside the back cover of this manual.

Note: Intercharacter delays are not supported in USB serial emulation.

Interfunction Delay

An interfunction delay of up to 495 milliseconds may be placed between the transmission of each segment of the message string. Scan the **Interfunction Delay** barcode below, then scan the number of milliseconds and the **SAVE** barcode using the [Programming Chart](#) inside the back cover of this manual.

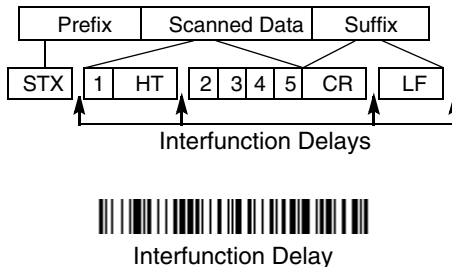

To remove this delay, scan the **Interfunction Delay** barcode, then set the number of steps to 0. Scan the **SAVE** barcode using the [Programming Chart](#) inside the back cover of this manual.

Intermessage Delay

An intermessage delay of up to 495 milliseconds may be placed between each scan transmission. Scan the **Intermessage Delay** barcode below, then scan the number of milliseconds and the **SAVE** barcode using the [Programming Chart](#) inside the back cover of this manual.

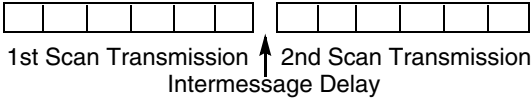

To remove this delay, scan the **Intermessage Delay** barcode, then set the number of steps to 0. Scan the **SAVE** barcode using the [Programming Chart](#) inside the back cover of this manual.

Data Format Editor Introduction

You may use the Data Format Editor to change the imager's output. For example, you can use the Data Format Editor to insert characters at certain points in barcode data as it is scanned. The selections in the following pages are used only if you wish to alter the output. *Default Data Format setting = None.*

Normally, when you scan a barcode, it gets outputted automatically; however when you do a format, you must use a "send" command (see [Send Commands](#) on page 5-2) within the format program to output data.

Multiple formats may be programmed into the imager. They are stacked in the order in which they are entered. However, the following list presents the order in which formats are applied:

1. Specific Term ID, Actual Code ID, Actual Length
2. Specific Term ID, Actual Code ID, Universal Length
3. Specific Term ID, Universal Code ID, Actual Length
4. Specific Term ID, Universal Code ID, Universal Length
5. Universal Term ID, Actual Code ID, Actual Length
6. Universal Term ID, Actual Code ID, Universal Length
7. Universal Term ID, Universal Code ID, Actual Length
8. Universal Term ID, Universal Code ID, Universal Length

If you have changed data format settings, and wish to clear all formats and return to the factory defaults, scan the **Default Data Format** code on [page 5-3](#).

To Add a Data Format

Step 1. Scan the **Enter Data Format** symbol ([page 5-3](#)).

Step 2. Terminal Type

Refer to the Supported Terminals Chart ([page 2-2](#)) and locate the Terminal ID number for your PC. Scan three numeric barcodes on the inside back cover to program the imager for your terminal ID (you must enter 3 digits). For example, scan **0 0 0** for an RS-232 TTL.

Note: The wildcard for all terminal types is 0099.

Step 3. Code I.D.

In the [Appendix A](#), find the symbology to which you want to apply the data format. Locate the Hex value for that symbology and scan the 2 digit hex value from the [Programming Chart](#) inside the back cover of this manual.

Step 4. Length

Specify what length (up to 9999 characters) of data will be acceptable for this symbology. Scan the four digit data length from the [Programming Chart](#) inside the back cover of this manual. (Note: 50 characters is entered as 0050. 9999 is a universal number, indicating all lengths.)

Step 5. Editor Commands

Refer to the Format Editor Commands Chart ([page 5-2](#)). Scan the symbols that represent the command you want to enter. 94 alphanumeric characters may be entered for each symbology data format.

Step 6. Scan **Save** from the [Programming Chart](#) inside the back cover of this manual to save your entries.

Other Programming Selections

- **Clear One Data Format**

This deletes one data format for one symbology. If you are clearing the primary format, scan **0** from the [Programming Chart](#) inside the back cover of this manual. If you are clearing an alternate format, scan **1**, **2**, or **3**, depending on the alternate format you are clearing. Scan the Terminal Type (refer to the Supported Terminals Chart on [page 2-2](#)), Code I.D. (refer to the [Symbology Chart](#) on page A-1), and the barcode data length for the specific data format that you want to delete. All other formats remain unaffected.

- **Save** from the [Programming Chart](#) inside the back cover of this manual
This exits, saving any Data Format changes.

- **Discard** from the [Programming Chart](#) inside the back cover of this manual
This exits without saving any Data Format changes.

Data Format Editor Commands

Send Commands

F1 Send all characters followed by “xx” key or function code, starting from current cursor position. **Syntax = F1xx** (xx stands for the hex value for an ASCII code, see [ASCII Conversion Chart \(Code Page 1252\)](#) on page A-2.)

F2 Send “nn” characters followed by “xx” key or function code, starting from current cursor position. **Syntax = F2nnxx** (nn stands for the numeric value (00-99) for the number of characters and xx stands for the hex value for an ASCII code. See [ASCII Conversion Chart \(Code Page 1252\)](#) on page A-2.)

F3 Send up to but not including “ss” character (Search and Send) starting from current cursor position, leaving cursor pointing to “ss” character followed by “xx” key or function code. **Syntax = F3ssxx** (ss and xx both stand for the hex values for ASCII codes, see [ASCII Conversion Chart \(Code Page 1252\)](#) on page A-2.)

F4 Send “xx” character “nn” times (Insert) leaving cursor in current cursor position. **Syntax = F4xxnn** (xx stands for the hex value for an ASCII code, see [ASCII Conversion Chart \(Code Page 1252\)](#) on page A-2, and nn is the numeric value (00-99) for the number of times it should be sent.)

Move Commands

- F5 Move the cursor ahead “nn” characters from current cursor position.
Syntax = F5nn (nn stands for the numeric value (00-99) for the number of characters the cursor should be moved ahead.)
- F7 Move the cursor to the beginning of the data string. **Syntax = F7.**

Miscellaneous Commands

- FE Compare character in current cursor position to the character “xx.” If characters are equal, increment cursor. If characters are not equal, no format match. **Syntax = FExx** (xx stands for the hex value for an ASCII code, see [ASCII Conversion Chart \(Code Page 1252\)](#) on page A-2.)

Data Format Editor



Enter Data Format



Clear One Data Format



Save



* Default Data Format



Clear All Data Formats



Discard

Data Formatter

When Data Formatter is turned off, the barcode data is output to the host as read (including prefixes and suffixes). Choose one of the following options. *Default = Data Formatter On.*



* Data Formatter On,
but Not Required



Data Formatter Off

When Data Formatter is required, all input data must conform to an edited format or the imager does not transmit the input data to the host device.



Data Format On, Format Required

Introduction

This programming section contains the following menu selections. Refer to [Chapter 9](#) for settings and defaults.

- All Symbologies
- China Post Code
- Codabar
- Code 11
- Code 39
- Code 32 Pharmaceutical (PARAF)
- Code 93
- Code 128
- UPC-A/EAN-13 with Extended Coupon Code
- EAN/JAN 8
- Interleaved 2 of 5
- Matrix 2 of 5
- MSI
- Plessey Code
- RSS-14
- Straight 2 of 5 IATA (two-bar start/stop)
- Straight 2 of 5 Industrial (three-bar start/stop)
- Telepen
- UPC A
- UPC E

All Symbologies

If you want to decode all the symbologies allowable for your imager, scan the **All Symbologies On** code. If on the other hand, you want to decode only a particular symbology, scan All Symbologies Off followed by the On symbol for that particular symbology.



All Symbologies On



All Symbologies Off

Message Length

You are able to set the valid reading length of some of the barcode symbologies. If the data length of the scanned barcode doesn't match the valid reading length, the imager will issue an error beep. You may wish to set the same value for minimum and maximum length to force the imager to read fixed length barcode data. This helps reduce the chances of a misread.

EXAMPLE: Decode only those barcodes with a count of 9-20 characters.
Min. length = 09 Max. length = 20

EXAMPLE: Decode only those barcodes with a count of 15 characters.
Min. length = 15 Max. length = 15

For a value other than the minimum and maximum message length defaults, scan the barcodes included in the explanation of the symbology, then scan the digit value of the message length and **Save** barcodes on the [Programming Chart](#) inside the back cover of this manual. The minimum and maximum lengths and the defaults are included with the respective symbologies.

Codabar

<Default All Codabar Settings>



Codabar



* On



Off

Codabar Start/Stop Characters

Start/Stop characters identify the leading and trailing ends of the barcode. You may either transmit, or not transmit Start/Stop characters.
Default = Don't Transmit.



Transmit



* Don't Transmit

Codabar Check Character

Codabar check characters are created using different “modulos.” You can program the imager to read only Codabar barcodes with Modulo 16 check characters. *Default = No Check Character.*

No Check Character indicates that the imager reads and transmits barcode data with or without a check character.

When Check Character is set to **Validate and Transmit**, the imager will only read Codabar barcodes printed with a check character, and will transmit this character at the end of the scanned data.

When Check Character is set to **Validate, but Don't Transmit**, the unit will only read Codabar barcodes printed **with** a check character, but will not transmit the check character with the scanned data.



* No Check Character



Validate Modulo 16, but
Don't Transmit



Validate Modulo 16 and Transmit

Codabar Message Length

Scan the barcodes below to change the message length. Refer to [Message Length](#) on page 6-1 for additional information. Minimum and Maximum lengths = 2-60. Minimum Default = 4, Maximum Default = 60.



Minimum Message Length



Maximum Message Length

Code 39

< Default All Code 39 Settings >



Code 39



* On



Off

Code 39 Start/Stop Characters

Start/Stop characters identify the leading and trailing ends of the barcode. You may either transmit, or not transmit Start/Stop characters. *Default = Don't Transmit.*



Transmit



* Don't Transmit

Code 39 Check Character

No Check Character indicates that the imager reads and transmits barcode data with or without a check character.

When Check Character is set to **Validate, but Don't Transmit**, the unit only reads Code 39 barcodes printed with a check character, but will not transmit the check character with the scanned data.

When Check Character is set to **Validate and Transmit**, the imager only reads Code 39 barcodes printed with a check character, and will transmit this character at the end of the scanned data. *Default = No Check Character.*



* No Check Character



Validate, but Don't Transmit



Validate and Transmit

Code 39 Message Length

Scan the barcodes below to change the message length. Refer to [Message Length](#) on page 6-1 for additional information. Minimum and Maximum lengths = 0-48. Minimum Default = 0, Maximum Default = 48.



Minimum Message Length



Maximum Message Length

Code 32 Pharmaceutical (PARAF)

Code 32 Pharmaceutical is a form of the Code 39 symbology used by Italian pharmacies. This symbology is also known as PARAF.



On



* Off

Full ASCII

If Full ASCII Code 39 decoding is enabled, certain character pairs within the barcode symbol will be interpreted as a single character. For example: \$V will be decoded as the ASCII character SYN, and /C will be decoded as the ASCII character #. *Default = Off.*

NUL %U	DLE \$P	SP SPACE	0 0	@ %V	P P	' %W	p +P
SOH \$A	DC1 \$Q	! /A	1 1	A A	Q Q	a +A	q +Q
STX \$B	DC2 \$R	" /B	2 2	B B	R R	b +B	r +R
ETX \$C	DC3 \$S	# /C	3 3	C C	S S	c +C	s +S
EOT \$D	DC4 \$T	\$ /D	4 4	D D	T T	d +D	t +T
ENQ \$E	NAK \$U	% /E	5 5	E E	U U	e +E	u +U
ACK \$F	SYN \$V	& /F	6 6	F F	V V	f +F	v +V
BEL \$G	ETB \$W	' /G	7 7	G G	W W	g +G	w +W
BS \$H	CAN \$X	(/H	8 8	H H	X X	h +H	x +X
HT \$I	EM \$Y) /I	9 9	I I	Y Y	i +I	y +Y
LF \$J	SUB \$Z	* /J	:	/Z	J J	Z Z	j +J z +Z
VT \$K	ESC %A	+ /K	;	%F	K K	[%K	k +K { %P
FF \$L	FS %B	, /L	<	%G	L L	\ %L	l +L %Q
CR \$M	GS %C	- -	=	%H	M M] %M	m +M } %R
SO \$N	RS %D	. .	>	%I	N N	^ %N	n +N ~ %S
SI \$O	US %E	/ /O	?	%J	O O	_ %O	o +O DEL %T

Character pairs /M and /N decode as a minus sign and period respectively. Character pairs /P through /Y decode as 0 through 9.



Full ASCII On



* Full ASCII Off

Code 39 Code Page

Code pages define the mapping of character codes to characters. If the data received does not display with the proper characters, it may be because the barcode being scanned was created using a code page that is different from the one the host program is expecting. If this is the case, scan the barcode below, select the code page with which the barcodes were created from the chart, [Code Page Mapping of Printed barcodes](#) on page A-4, and scan the value and the **SAVE** barcode from the [Programming Chart](#) inside the back cover of this manual. The data characters should then appear properly.



Code 39 Code Page

Interleaved 2 of 5

< *Default All Interleaved 2 of 5 Settings* >



Interleaved 2 of 5



* On



Off

Check Digit

No Check Digit indicates that the imager reads and transmits barcode data with or without a check digit.

When Check Digit is set to **Validate, but Don't Transmit**, the unit only reads Interleaved 2 of 5 barcodes printed with a check digit, but will not transmit the check digit with the scanned data.

When Check Digit is set to **Validate and Transmit**, the imager only reads Interleaved 2 of 5 barcodes printed with a check digit, and will transmit this digit at the end of the scanned data. *Default = No Check Digit.*



* No Check Digit



Validate, but Don't Transmit



Validate and Transmit

Interleaved 2 of 5 Message Length

Scan the barcodes below to change the message length. Refer to [Message Length](#) on page 6-1 for additional information. Minimum and Maximum lengths = 2-80. Minimum Default = 4, Maximum Default = 80.



Minimum Message Length



Maximum Message Length

Code 93

< Default All Code 93 Settings >



Code 93



* On



Off

Code 93 Message Length

Scan the barcodes below to change the message length. Refer to [Message Length](#) on page 6-1 for additional information. Minimum and Maximum lengths = 0-80. Minimum Default = 0, Maximum Default = 80.



Minimum Message Length



Maximum Message Length

Code 93 Code Page

Code pages define the mapping of character codes to characters. If the data received does not display with the proper characters, it may be because the barcode being scanned was created using a code page that is different from the one the host program is expecting. If this is the case, scan the barcode below, select the code page with which the barcodes were created from the chart, [Code Page Mapping of Printed barcodes](#) on page A-4, and scan the value and the **SAVE** barcode from the [Programming Chart](#) inside the back cover of this manual. The data characters should then appear properly.



Code 93 Code Page

Straight 2 of 5 Industrial (three-bar start/stop)

<Default All Straight 2 of 5 Settings>



Straight 2 of 5 Industrial



On



* Off

Straight 2 of 5 Industrial Message Length

Scan the barcodes below to change the message length. Refer to [Message Length](#) on page 6-1 for additional information. Minimum and Maximum lengths = 1-48. Minimum Default = 4, Maximum Default = 48.



Minimum Message Length



Maximum Message Length

Straight 2 of 5 IATA (two-bar start/stop)

<Default All Code IATA 2 of 5 Settings>



Straight 2 of 5 IATA



On



* Off

Straight 2 of 5 IATA Message Length

Scan the barcodes below to change the message length. Refer to [Message Length](#) on page 6-1 for additional information. Minimum and Maximum lengths = 1-48. Minimum Default = 4, Maximum Default = 48.



Minimum Message Length



Maximum Message Length

Matrix 2 of 5

<Default All Matrix 2 of 5 Settings>



Matrix 2 of 5



On



* Off

Matrix 2 of 5 Message Length

Scan the barcodes below to change the message length. Refer to [Message Length](#) on page 6-1 for additional information. Minimum and Maximum lengths = 1-80. Minimum Default = 4, Maximum Default = 80.



Minimum Message Length



Maximum Message Length

Code 11

<Default All Code 11 Settings>



Code 11



On



* Off

Check Digits Required

This option sets whether 1 or 2 check digits are required with Code 11 barcodes. *Default = Two Check Digits.*



One Check Digit



* Two Check Digits

Code 11 Message Length

Scan the barcodes below to change the message length. Refer to [Message Length](#) on page 6-1 for additional information. Minimum and Maximum lengths = 1-80. Minimum Default = 4, Maximum Default = 80.



Minimum Message Length



Maximum Message Length

Code 128

<Default All Code 128 Settings>



Code 128



* On



Off

ISBT 128 Concatenation

In 1994 the International Society of Blood Transfusion (ISBT) ratified a standard for communicating critical blood information in a uniform manner. The use of ISBT formats requires a paid license. The ISBT 128 Application Specification describes 1) the critical data elements for labeling blood products, 2) the current recommendation to use Code 128 due to its high degree of security and its space-efficient design, 3) a variation of Code 128 that supports concatenation of neighboring symbols, and 4) the standard layout for barcodes on a blood product label. Use the barcodes below to turn concatenation on or off. *Default = Off.*



On



* Off

Code 128 Message Length

Scan the barcodes below to change the message length. Refer to [Message Length](#) on page 6-1 for additional information. Minimum and Maximum lengths = 0-80. Minimum Default = 0, Maximum Default = 80.



Minimum Message Length



Maximum Message Length

Code 128 Code Page

Code pages define the mapping of character codes to characters. If the data received does not display with the proper characters, it may be because the barcode being scanned was created using a code page that is different from the one the host program is expecting. If this is the case, scan the barcode below, select the code page with which the barcodes were created from the chart, [Code Page Mapping of Printed barcodes](#) on page A-4, and scan the value and the **SAVE** barcode from the [Programming Chart](#) inside the back cover of this manual. The data characters should then appear properly.



Code 128 Code Page

Code 128 Function Code Transmit

By default, Code 128 function codes are not transmitted with Code 128 barcode data. However, if you wish to transmit Code 128 function codes with the barcode data, scan the **Function Codes On** barcode, below.



* Function Codes Off



Function Codes On

Telepen

<Default All Telepen Settings>



Telepen



On



* Off

Telepen Output

Using AIM Telepen Output, the imager reads symbols with start/stop pattern 1 and decodes them as standard full ASCII (start/stop pattern 1). When Original Telepen Output is selected, the imager reads symbols with start/stop pattern 1 and decodes them as compressed numeric with optional full ASCII (start/stop pattern 2). *Default = AIM Telepen Output.*



* AIM Telepen Output



Original Telepen Output

Telepen Message Length

Scan the barcodes below to change the message length. Refer to [Message Length](#) on page 6-1 for additional information. Minimum and Maximum lengths = 1-60. Minimum Default = 1, Maximum Default = 60.



Minimum Message Length



Maximum Message Length

UPC A

<Default All UPC A Settings>



UPC A



* On



Off

UPC A Check Digit

This selection allows you to specify whether the check digit should be transmitted at the end of the scanned data or not. Default = On.



* On



Off

UPC A Number System

The numeric system digit of a U.P.C. symbol is normally transmitted at the beginning of the scanned data, but the unit can be programmed so it will not transmit it. *Default = On.*



* On



Off

UPC A Addenda

This selection adds 2 or 5 digits to the end of all scanned UPC A data.
Default = Off for both 2 Digit Addenda and 5 Digit Addenda.



2 Digit Addenda On



* 2 Digit Addenda Off



5 Digit Addenda On



* 5 Digit Addenda Off

UPC A Addenda Required

When Addenda Required is set to on, the imager will only read UPC A barcodes that have addenda. *Default = Not Required.*



Required



* Not Required

UPC-A/EAN-13 with Extended Coupon Code

Use the following codes to enable or disable UPC-A **and** EAN-13 with Extended Coupon Code. *Default = On.*



* On



Off

UPC E

<Default All UPC E Settings>



UPC E0 and UPC E1

Most U.P.C. barcodes lead with the 0 number system. For these codes, use the UPC E0 selection. If you need to read codes that lead with the 1 number system, use the UPC E1 selection. *Default = On (UPC E0) and Off (UPC E1).*



* UPC E0 On



UPC E0 Off



UPC E1 On



* UPC E1 Off

UPC E0 and UPC E1 Expand

UPC E Expand expands the UPC E code to the 12 digit, UPC A format. *Default = Off.*



On



* Off

UPC E0 and UPC E1 Addenda Required

When Addenda Required is set to on, the imager will only read UPC E barcodes that have addenda. *Default = Not Required.*



Required



* Not Required

UPC E0 Check Digit

Check Digit specifies whether the check digit should be transmitted at the end of the scanned data or not. *Default = On.*



* On



Off

UPC E0 Number System

The numeric system digit of a U.P.C. symbol is normally transmitted at the beginning of the scanned data, but the unit can be programmed so it will not transmit it. *Default = On.*



* On



Off

UPC E0 Addenda

This selection adds 2 or 5 digits to the end of all scanned UPC E data.
Default = Off for both 2 Digit and 5 Digit Addenda.



2 Digit Addenda On



* 2 Digit Addenda Off



5 Digit Addenda On



* 5 Digit Addenda Off

EAN/JAN 13

<Default All EAN/JAN Settings>



EAN/JAN 13



* On



Off

EAN/JAN 13 Check Digit

This selection allows you to specify whether the check digit should be transmitted at the end of the scanned data or not. *Default = On.*



* On



Off

EAN/JAN 13 Addenda

This selection adds 2 or 5 digits to the end of all scanned EAN/JAN 13 data.
Default = Off for both 2 Digit and 5 Digit Addenda.



2 Digit Addenda On



* 2 Digit Addenda Off



5 Digit Addenda On



* 5 Digit Addenda Off

EAN/JAN 13 Addenda Required

When Addenda Required is set to on, the imager will only read EAN/JAN 13 barcodes that have addenda. *Default = Not Required.*



Required



* Not Required

EAN/JAN 13 Addenda Separator

When this feature is on, there is a space between the data from the barcode and the data from the addenda. When turned off, there is no space.
Default = On.



* On



Off

Note: If you want to enable or disable EAN13 with Extended Coupon Code, refer to [UPC-A/EAN-13 with Extended Coupon Code](#) on page 6-17.

ISBN Translate

This selection causes EAN-13 Bookland symbols to be translated into their equivalent ISBN number format. *Default = Off.*



On



* Off

EAN/JAN 8

<Default All EAN/JAN 8 Settings>



EAN/JAN 8



* On



Off

EAN/JAN 8 Check Digit

This selection allows you to specify whether the check digit should be transmitted at the end of the scanned data or not. *Default = On.*



* On



Off

EAN/JAN 8 Addenda

This selection adds 2 or 5 digits to the end of all scanned EAN/JAN 8 data.
Default = Off for both 2 Digit and 5 Digit Addenda.



2 Digit Addenda On



* 2 Digit Addenda Off



5 Digit Addenda On



* 5 Digit Addenda Off

EAN/JAN 8 Addenda Required

When Addenda Required is set to on, the imager will only read EAN/JAN 8 barcodes that have addenda. *Default = Not Required.*



Required



* Not Required

EAN/JAN 8 Addenda Separator

When this feature is on, there is a space between the data from the barcode and the data from the addenda. When turned off, there is no space.
Default = On.



* On



Off

MSI

<Default All MSI Settings>



MSI



On



* Off

MSI Check Character

Different types of check characters are used with MSI barcodes. You can program the imager to read MSI barcodes with Type 10 check characters. *Default = Validate Type 10, but Don't Transmit.*

When Check Character is set to **Validate and Transmit**, the imager will only read MSI barcodes printed with the specified type check character, and will transmit this character at the end of the scanned data.

When Check Character is set to **Validate, but Don't Transmit**, the unit will only read MSI barcodes printed with the specified type check character, but will not transmit the check character with the scanned data.



* Validate Type 10, but Don't
Transmit



Validate Type 10 and Transmit

MSI Message Length

Scan the barcodes below to change the message length. Refer to [Message Length](#) on page 6-1 for additional information. Minimum and Maximum lengths = 4-48. Minimum Default = 4, Maximum Default = 48.



Minimum Message Length



Maximum Message Length

Plessey Code

<Default All Plessey Code Settings>



Plessey Code



On



* Off

Plessey Message Length

Scan the barcodes below to change the message length. Refer to [Message Length](#) on page 6-1 for additional information. Minimum and Maximum lengths = 4-48. Minimum Default = 4, Maximum Default = 48.



Minimum Message Length



Maximum Message Length

RSS-14

< Default All RSS-14 Settings >



RSS-14



* On



Off

RSS Limited

< Default All RSS Limited Settings >



RSS Limited



* On



Off

RSS Expanded

< Default All RSS Expanded Settings >



RSS Expanded



* On



Off

RSS Expanded Message Length

Scan the barcodes below to change the message length. Refer to [Message Length](#) on page 6-1 for additional information. Minimum and Maximum lengths = 4-74. Minimum Default = 4, Maximum Default = 74.



Minimum Message Length



Maximum Message Length

EAN•UCC Emulation

The imager can automatically format the output from any EAN•UCC data carrier to emulate what would be encoded in an equivalent UCC/EAN-128 or RSS+Composite symbol. EAN•UCC data carriers include UPC-A and UPC-E, EAN-13 and EAN-8, ITF-14, UCC/EAN-128, and EAN•UCC RSS and Composites. If UCC/EAN-128 Emulation is selected, the AIM Symbology Identifier will be reported as “]C1”. If RSS Emulation is selected, the AIM Symbology Identifier will be reported as “]e0.” Any application that accepts EAN•UCC data can be simplified since it only needs to recognize one data carrier type. *Default = EAN•UCC Emulation Off.*



RSS Emulation



128 Emulation



* EAN•UCC Emulation Off

China Post Code

<Default All China Post Code Settings>



China Post Code



On



* Off

China Post Message Length

Scan the barcodes below to change the message length. Refer to [Message Length](#) on page 6-1 for additional information. Minimum and Maximum lengths = 2-80. Minimum Default = 4, Maximum Default = 80.



Minimum Message Length



Maximum Message Length

Keyboard Function Relationships

The following Keyboard Function Code, Hex/ASCII Value, and Full ASCII "CTRL"+ relationships apply to all terminals that can be used with the imager. Refer to page 2-5 enable Control + ASCII mode.

Function Code	HEX/ASCII Value	Full ASCII "CTRL" +
NUL	00	2
SOH	01	A
STX	02	B
ETX	03	C
EOT	04	D
ENQ	05	E
ACK	06	F
BEL	07	G
BS	08	H
HT	09	I
LF	0A	J
VT	0B	K
FF	0C	L
CR	0D	M
SO	0E	N
SI	0F	O
DLE	10	P
DC1	11	Q
DC2	12	R
DC3	13	S
DC4	14	T
NAK	15	U
SYN	16	V
ETB	17	W
CAN	18	X
EM	19	Y
SUB	1A	Z
ESC	1B	[
FS	1C	\
GS	1D]
RS	1E	6
US	1F	-

The last five characters in the Full ASCII “CTRL”+ column ([\]6 -), apply to US only. The following chart indicates the equivalents of these five characters for different countries.

Country	Codes				
United States	[\]	6	-
Belgium	[<]	6	-
Scandinavia	8	<	9	6	-
France	^	8	\$	6	=
Germany		Ã	+	6	-
Italy		\	+	6	-
Switzerland		<	..	6	-
United Kingdom	[¢]	6	-
Denmark	8	\	9	6	-
Norway	8	\	9	6	-
Spain	[\]	6	-

Supported Interface Keys

ASCII	HEX	IBM AT/XT and PS/2 Compatibles, WYSE PC/AT Supported Keys	IBM XTs and Compatibles Supported Keys
NUL	00	Reserved	Reserved
SOH	01	Enter (KP)	CR/Enter
STX	02	Cap Lock	Caps Lock
ETX	03	ALT make	Reserved
EOT	04	ALT break	Reserved
ENQ	05	CTRL make	Reserved
ACK	06	CTRL break	Reserved
BEL	07	CR/Enter	CR/Enter
BS	08	Reserved	Reserved
HT	09	Tab	Tab
LF	0A	Reserved	Reserved
VT	0B	Tab	Tab
FF	0C	Delete	Delete
CR	0D	CR/Enter	CR/Enter
SO	0E	Insert	Insert
SI	0F	Escape	Escape
DLE	10	F11	Reserved
DC1	11	Home	Home
DC2	12	Print	Print
DC3	13	Back Space	Back Space
DC4	14	Back Tab	Back Tab
NAK	15	F12	Reserved
SYN	16	F1	F1
ETB	17	F2	F2
CAN	18	F3	F3
EM	19	F4	F4
SUB	1A	F5	F5
ESC	1B	F6	F6
FS	1C	F7	F7
GS	1D	F8	F8
RS	1E	F9	F9
US	1F	F10	F10

* IBM 3191/92, 3471/72, 3196/97, 3476/77, Telex (all models)



To Add a Test Code I.D. Prefix to All Symbologies

This selection allows you to turn on transmission of a Code I.D. before the decoded symbology. (See the Symbology Chart, included in the [Appendix A](#), page A-1) for the single character code that identifies each symbology.) This action first clears all current prefixes, then programs a Code I.D. prefix for all symbologies. This is a temporary setting that will be removed when the unit is power cycled.



Add Code I.D. Prefix to
All Symbologies (Temporary)

Show Software Revision

Scan the barcode below to output the current software revision, unit serial number, and other product information.



Show Revision

Show Data Format

Scan the barcode below to show current data format settings.



Data Format Settings

Resetting the Standard Product Defaults

If you aren't sure what programming options are in your imager, or you've changed some options and want the standard product default settings restored, scan the **Standard Product Default Settings** barcode below.



Standard Product Default Settings

The [Menu Commands](#) starting on [page 9-1](#) lists the standard product default settings for each of the commands (indicated by an asterisk (*) on the programming pages).



Default Chart

Resetting the Standard Product Defaults

If you aren't sure what programming options are in your imager, or you've changed some options and want the factory settings restored, scan the **Standard Product Default Settings** barcode below.



Standard Product Default Settings

The chart on the following pages lists the factory default settings for each of the menu commands (indicated by an asterisk (*) on the programming pages).

Menu Commands

The following chart lists all of the menu commands and the defaults and ranges for each entry.

Selection	Setting <i>* Indicates default</i>	Page
Factory Default Settings	Default	
<i>Terminal Interfaces</i>		
Terminal ID	USB PC Keyboard	2-2
Program Keyboard Country	*USA	2-3
	Belgium	2-3
	Denmark	2-3
	Finland	2-3
	France	2-3
	Germany/Austria	2-3
	Great Britain	2-3
	Italy	2-3
	Norway	2-3
	Spain	2-3
	Switzerland	2-3
Keyboard Style	*Regular	2-4
	Emulate External Keyboard	2-4

Selection	Setting <i>* Indicates default</i>	Page
Keyboard Modifiers	*Control + ASCII Off	2-5
	Control + ASCII On	2-5
	*Numeric Keypad Off	2-5
	Numeric Keypad On	2-5
	*Auto Direct Conn. Off	2-5
	Auto Direct Conn. On	2-5
Serial Port Connection	RS-232	1-5
Baud Rate	300 BPS	2-6
	600 BPS	2-6
	1200 BPS	2-6
	2400 BPS	2-6
	4800 BPS	2-6
	9600 BPS	2-6
	19200 BPS	2-6
	*38400 BPS	2-6
57600 BPS	2-6	
Word Length: Data Bits, Stop Bits, and Parity	7 Data, 1 Stop, Parity Even	2-7
	7 Data, 1 Stop, Parity None	2-7
	7 Data, 1 Stop, Parity Odd	2-7
	7 Data, 2 Stop, Parity Even	2-7
	7 Data, 2 Stop, Parity None	2-7
	7 Data, 2 Stop, Parity Odd	2-7
	8 Data, 1 Stop, Parity Even	2-7
	*8 Data, 1 Stop, Parity None	2-7
	8 Data, 1 Stop, Parity Odd	2-7
RS-232 Handshaking	*RTS/CTS Off	2-8
	RTS/CTS On	2-8
	*XON/XOFF Off	2-8
	XON/XOFF On	2-8
	*ACK/NAK Off	2-8
	ACK/NAK On	2-8
<i>Output Selections</i>		
Beeper - Good Read	Off	3-1
	*On	3-1

Selection	Setting <i>* Indicates default</i>	Page
Beeper Volume - Good Read	Off	3-1
	Low	3-1
	Medium	3-1
	*High	3-1
Beeper Pitch - Good Read (Frequency)	Low (1600) (min 400Hz)	3-1
	*Medium (2550)	3-1
	High (4200) (max 9000Hz)	3-1
Trigger Mode	*Manual/Serial Trigger	3-1
	Automatic Trigger	3-2
Reread Delay	Short (500 ms)	3-2
	*Medium (750 ms)	3-2
	Long (1000 ms)	3-2
	Extra Long (2000 ms)	3-2
<i>Prefix/Suffix Selections</i>		
Add CR Suffix to All Symbolologies		4-3
Prefix	Add Prefix	4-3
	Clear One Prefix	4-3
	Clear All Prefixes	4-3
Suffix	Add Suffix	4-4
	Clear One Suffix	4-4
	Clear All Suffixes	4-4
Function Code Transmit	*Enable	4-4
	Disable	4-4
Intercharacter Delay		4-5
Interfunction Delay		4-5
Intermessage Delay		4-6
<i>Data Formatter Selections</i>		
Data Format Editor	*Default Data Format (None)	5-3
	Enter Data Format	5-3
	Clear One Data Format	5-3
	Clear All Data Formats	5-3
Data Formatter	Off	5-4
	*On, but Not Required	5-4
	On, Required	5-4

Selection	Setting <i>* Indicates default</i>	Page
<i>Symbologies</i>		
All Symbologies	All Symbologies Off	6-1
	All Symbologies On	6-1
Codabar	Default All Codabar Settings	6-2
Codabar	Off	6-2
	*On	6-2
Codabar Start/Stop Char.	*Don't Transmit	6-2
	Transmit	6-2
Codabar Check Char.	*No Check Char.	6-3
	Validate, But Don't Transmit	6-3
	Validate, and Transmit	6-3
Codabar Message Length	Minimum (2 - 60) *4	6-3
	Maximum (2 - 60) *60	6-3
Code 39	Default All Code 39 Settings	6-4
Code 39	Off	6-4
	*On	6-4
Code 39 Start/Stop Char.	*Don't Transmit	6-4
	Transmit	6-4
Code 39 Check Char.	*No Check Char.	6-5
	Validate, But Don't Transmit	6-5
	Validate, and Transmit	6-5
Code 39 Message Length	Minimum (0 - 48) *0	6-5
	Maximum (0 - 48) *48	6-5
Code 32 Pharmaceutical (PARAF)	*Off	6-5
	On	6-5
Code 39 Full ASCII	*Off	6-6
	On	6-6
Interleaved 2 of 5	Default All Interleaved 2 of 5 Settings	6-7
Interleaved 2 of 5	Off	6-7
	*On	6-7

Selection	Setting <i>* Indicates default</i>	Page
Interleaved 2 of 5 Check Digit	*No Check Char.	6-8
	Validate, But Don't Transmit	6-8
	Validate, and Transmit	6-8
Interleaved 2 of 5 Message Length	Minimum (2 - 80) *4	6-8
	Maximum (2 - 80) *80	6-8
Code 93	Default All Code 93 Settings	6-9
Code 93	Off	6-9
	*On	6-9
Code 93 Message Length	Minimum (0 - 80) *0	6-9
	Maximum (0 - 80) *80	6-9
Straight 2 of 5 Industrial	Default All Straight 2 of 5 Settings	6-10
Straight 2 of 5 Industrial	*Off	6-10
	On	6-10
Straight 2 of 5 Industrial Message Length	Minimum (1 - 48) *4	6-10
	Maximum (1 - 48) *48	6-10
Straight 2 of 5 IATA	Default All Straight 2 of 5 IATA Settings	6-11
Straight 2 of 5 IATA	*Off	6-11
	On	6-11
Straight 2 of 5 IATA Message Length	Minimum (1 - 48) *4	6-11
	Maximum (1 - 48) *48	6-11
Matrix 2 of 5	Default All Matrix 2 of 5 Settings	6-11
Matrix 2 of 5	*Off	6-11
	On	6-11
Matrix 2 of 5 Message Length	Minimum (1 - 80) *4	6-12
	Maximum (1 - 80) *80	6-12
Code 11	Default All Code 11 Settings	6-12
Code 11	*Off	6-12
	On	6-12
Code 11 Check Digits Required	1 Check Digit	6-12
	*2 Check Digits	6-12

Selection	Setting <i>* Indicates default</i>	Page
Code 11 Message Length	Minimum (1 - 80) *4	6-13
	Maximum (1 - 80) *80	6-13
Code 128	Default All Code 128 Settings	6-13
Code 128	Off	6-13
	*On	6-13
ISBT Concatenation	On	6-13
	*Off	6-13
Code 128 Message Length	Minimum (0 - 80) *0	6-14
	Maximum (0 - 80) *80	6-14
Code 128 Code Page	Code 128 Code Page	6-14
Code 128 Function Code Transmit	*Off	6-14
	On	6-14
ISBT Concatenation	*Off	6-13
	On	6-13
Telepen	Default All Telepen Settings	6-15
Telepen	*Off	6-15
	On	6-15
Telepen Output	*AIM Telepen Output	6-15
	Original Telepen Output	6-15
Telepen Message Length	Minimum (1 - 60) *1	6-15
	Maximum (1 - 60) *60	6-15
UPC A	Default All UPC A Settings	6-16
UPC A	Off	6-16
	*On	6-16
UPC A Check Digit	Off	6-16
	*On	6-16
UPC A Number System	Off	6-16
	*On	6-16
UPC A 2 Digit Addenda	*Off	6-17
	On	6-17
UPC A 5 Digit Addenda	*Off	6-17
	On	6-17

Selection	Setting <i>* Indicates default</i>	Page
UPC A Addenda Required	*Not Required	6-17
	Required	6-17
UPC E	Default All UPC E Settings	6-18
UPC E0	Off	6-18
	*On	6-18
UPC E1	*Off	6-18
	On	6-18
UPC E Expand	*Off	6-18
	On	6-18
UPC E Check Digit	Off	6-19
	*On	6-19
UPC E Number System	Off	6-19
	*On	6-19
UPC E 2 Digit Addenda	*Off	6-20
	On	6-20
UPC E 5 Digit Addenda	*Off	6-20
	On	6-20
UPC E Addenda Required	*Not Required	6-19
	Required	6-19
EAN/JAN 13	Default All EAN/ JAN 13 Settings	6-20
EAN/JAN 13	Off	6-20
	*On	6-20
EAN/JAN 13 Check Digit	Off	6-20
	*On	6-20
EAN/JAN 13 2 Digit Addenda	*Off	6-21
	On	6-21
EAN/JAN 13 5 Digit Addenda	*Off	6-21
	On	6-21
EAN/JAN 13 Addenda Required	*Not Required	6-21
	Required	6-21
EAN/JAN 13 Addenda Separator	Off	6-21
	*On	6-21
ISBN Translate	*Off	6-22
	On	6-22

Selection	Setting <i>* Indicates default</i>	Page
EAN/JAN 8	Default All EAN/ JAN 8 Settings	6-22
EAN/JAN 8	Off	6-22
	*On	6-22
EAN/JAN 8 Check Digit	Off	6-22
	*On	6-22
EAN/JAN 8 2 Digit Addenda	*Off	6-23
	On	6-23
EAN/JAN 8 5 Digit Addenda	*Off	6-23
	On	6-23
EAN/JAN 8 Addenda Required	*Not Required	6-23
	Required	6-23
EAN/JAN 8 Addenda Separator	Off	6-23
	*On	6-23
Coupon Code	Off	6-23
	*On	6-17
MSI	Default All MSI Settings	6-24
MSI	*Off	6-24
	On	6-24
MSI Check Character	*Validate Type 10, but Don't Transmit	6-24
	Validate Type 10 and Transmit	6-24
MSI Message Length	Minimum (4 - 48) *4	6-25
	Maximum (4 - 48) *48	6-25
Plessey Code	Default All Plessey Settings	6-25
Plessey Code	*Off	6-25
	On	6-25
Plessey Message Length	Minimum (4 - 48) *4	6-25
	Maximum (4 - 48) *48	6-25
RSS-14	Default All RSS-14 Settings	6-26
RSS-14	Off	6-26
	*On	6-26
RSS Limited	Default All RSS-14 Limited Settings	6-26

Selection	Setting <i>* Indicates default</i>	Page
RSS Limited	Off	6-26
	*On	6-26
RSS Expanded	Default All RSS-14 Expanded Settings	6-27
RSS Expanded	Off	6-27
	*On	6-27
RSS Expanded Msg. Length	Minimum (4 - 74) *4	6-27
	Maximum (4 - 74) *74	6-27
EAN•UCC Emulation	RSS Emulation	6-27
	128 Emulation	6-27
	*EAN•UCC Emulation Off	6-27
China Post Code	Default All China Post Code Settings	6-28
China Post Code	*Off	6-28
	On	6-28
China Post Code Msg. Length	Minimum (2 - 80) *4	6-28
	Maximum (2 - 80) *80	6-28



Product Specifications

3200 Product Specifications

<i>Parameter</i>	<i>Specification</i>
Dimensions (Typical):	
Height	3.8 inches (9.52 cm)
Length	6 inches (15.3 cm)
Width	2.7 inches (6.8 cm)
Weight	5.1 ounces (145 g)
Light Source	626 nm ± 30nm visible red LED
Scan Rate	270 scans per second in most usages
Skew Angle	±55 degrees
Pitch Angle	±55 degrees
Scan Contrast	20% minimum
Voltage Requirements	5VDC ±5% at imager
Current Draw (Max):	<u>Scanning</u> <u>Standby</u>
3200 @ 4.75 - 5.25Vdc	245mA 90mA
Temperature Ranges:	
Operating	32° F to +122° F (0° C to +50° C)
Storage	-4° F to +140° F (-20° C to +60° C)
Humidity	0 to 95% non-condensing at 122° F (50° C)
Mechanical Drop	Operational after 25 drops from 4 feet (1.2 m) to concrete
Vibration	Withstands 5G peak from 22 to 300 Hz
ESD Sensitivity	8 kV Air discharge
Sealant Rating	IP41
Product Agency Compliance	International: IEC60825-1 Eye Safety (Class 1 LED) Japan: VCCI Taiwan: BSMI South Korea: MIC Australia/NZ: C-Tick marked. Europe: CE 2004/108/EC EMC directive (Class B EMI) USA: FCC (Class B) Canada: ICES-003 (Class B)

Standard Cable Pinouts

Keyboard Wedge

10 Pin RJ41 Modular Plug
connects to the imager handle

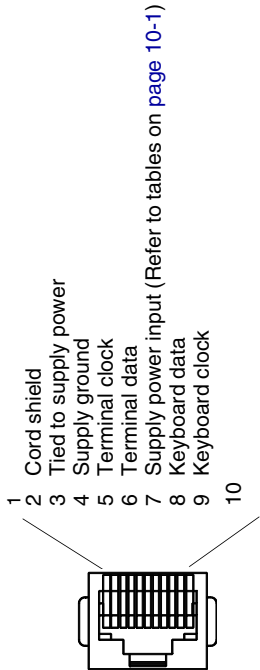

Standard Cable Pinouts

Serial Output

10 Pin RJ41 Modular Plug
connects to the imager handle

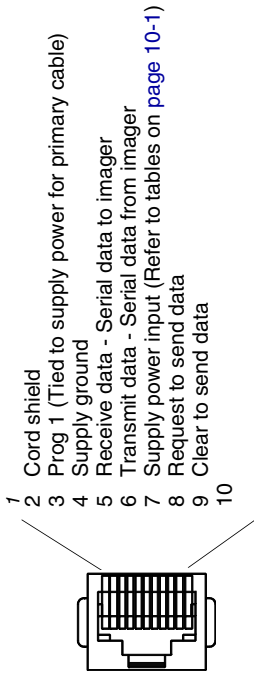

Standard Cable Pinouts

USB

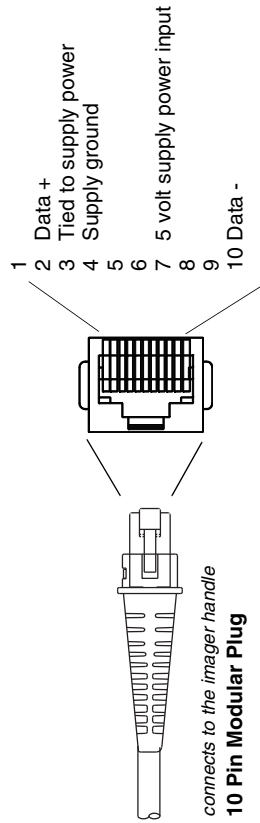

Repairs

Repairs and/or upgrades are not to be performed on this product. These services are to be performed only by an authorized service center. Please see [Customer Support](#) on page 12-1 for further information.

Maintenance

The 3200 provides reliable and efficient operation with a minimum of care. Although specific maintenance is not required, the following periodic checks ensure dependable scanner operation:

Cleaning the Device

Reading performance may degrade if the scanner's window is not clean. If the window is visibly dirty, or if the scanner isn't operating well, clean the window with a soft cloth or lens tissue dampened with water (or a mild soapy water solution). If a soapy water solution is used, rinse with a clean lens tissue dampened with water only.

The scanner's housing may also be cleaned the same way.



Caution:

Do not submerge the imager in water. Do not use abrasive wipes or tissues on the imager's window – abrasive wipes may scratch the window.

Never use solvents (e.g., acetone, benzene, ether, or phenol-based agents) on the housing or window – solvents may damage the finish or the window.

Inspecting Cords and Connectors

Inspect the scanner's interface cable and connector for wear or other signs of damage. A badly worn cable or damaged connector may interfere with scanner operation. Contact your Hand Held Products distributor for information about cable replacement. Cable replacement instructions are on [page 11-2](#).

Replacing the Interface Cable

The standard interface cable is attached to the scanner with an 10-pin modular connector. When properly seated, the connector is held in the 3200 scanner's handle by a flexible retention tab. The interface cable is designed to be field replaceable.

- Order replacement cables from Hand Held Products or from an authorized distributor.
- When ordering a replacement cable, specify either the 6 ft. USB cable (p/n AMCBC000800DAR0) or the 6 ft keyboard wedge cable (p/n AMCBC000900DAR0).

To Replace the 3200 Interface Cable:

1. Turn the power to the host system OFF.
2. Disconnect the scanner's cable from the terminal or computer.
3. Locate the small hole on the bottom of the scanner's handle. This is the cable release.
4. Straighten one end of a paper clip.
5. Insert the end of the paper clip into the small hole and press in. This depresses the retention tab, releasing the connector. Pull the connector out while maintaining pressure on the paper clip, then remove the paper clip.
6. Replace with the new cable. Insert the connector into the opening and press firmly. The connector is keyed to go in only one way, and will click into place.

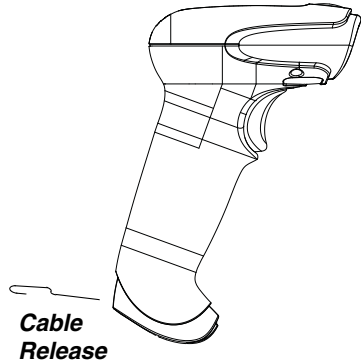

Troubleshooting

The scanner automatically performs self-tests whenever you turn it on. If your scanner is not functioning properly, review the following Troubleshooting Guide to try to isolate the problem.

Is the power on? Is the red aiming illumination line on?

If the red aiming illumination line isn't illuminated, check that:

- The cable is connected properly.
- The host system power is on (if external power isn't used).
- The trigger works.

Is the scanner having trouble reading your symbols?

If the scanner isn't reading symbols well, check that the symbols:

- Aren't smeared, rough, scratched, or exhibiting voids.
- Aren't coated with frost or water droplets on the surface.
- Are enabled in the scanner or in the decoder to which the scanner connects.

Is the barcode displayed but not entered?

The barcode is displayed on the host device correctly, but you still have to press a key to enter it (the Enter/Return key or the Tab key, for example).

You need to program a suffix. Programming a suffix enables the scanner to output the barcode data plus the key you need (such as "CR") to enter the data into your application. Refer to [Prefix/Suffix Overview](#) on page 4-1 for further information.

Does the scanner read the barcode incorrectly?

If the scanner reads a barcode, but the data is not displayed correctly on the host screen:

- The scanner may not be programmed for the appropriate terminal interface. For example, you scan "12345" and the host displays "@es%."

Reprogram the scanner with the correct Plug and Play or Terminal selection barcode. See [Chapter 1](#) and [Chapter 2](#).

- The scanner may not be programmed to output your barcode data properly. For example, you scan "12345" and the host displays "A12345B."

Reprogram the scanner with the proper symbology selections. See [Chapter 6](#).

The scanner won't read your barcode at all.

1. Scan the sample barcodes in the back of this manual. If the scanner reads the sample barcodes, check that your barcode is readable. Verify that your barcode symbology is enabled (see [Chapter 6](#)).
2. If the scanner still can't read the sample barcodes, scan [All Symbologies](#) on page 6-1.

If you aren't sure what programming options have been set in the scanner, or if you want the factory default settings restored, scan [Resetting the Standard Product Defaults](#) on page 9-1.



Technical Assistance

If you need assistance installing or troubleshooting, please call your Distributor or the nearest Hand Held Products technical support office:

North America/Canada

Telephone: (800) 782-4263
Fax number: (315) 554-6705
E-mail: natechsupport@handheld.com

Latin America

Telephone: (803) 835-8000
Telephone: (800) 782-4263
E-mail: latechsupport@handheld.com

Brazil

Telephone: +55 (21) 3535-9100
Fax: +55 (21) 3535-9105
E-mail: brsuporte@handheld.com

Mexico

Telephone: (803) 835-8000
E-mail: latechsupport@handheld.com

Europe, Middle East, and Africa

Telephone: +31 (0) 40 7999 393
Fax: +31 (0) 40 2425 672
E-mail: eurosupport@handheld.com

Asia Pacific

Telephone - Hong Kong: +852-3188-3485 or 2511-3050
Telephone - China: +86 21 6361 3818
E-mail: aptechsupport@handheld.com

Japan

Telephone: +813 5770-6312
E-mail: aptechsupport@handheld.com

Malaysia

Telephone: +603-6201-7020
E-mail: aptechsupport@handheld.com

Online Technical Assistance

You can also access technical assistance online at www.handheld.com.

For Further Information

To download the full User's Guide for these products, visit our website at www.handheld.com.

Product Service and Repair

Hand Held Products provides service for all its products through service centers throughout the world. To obtain warranty or non-warranty service, return the unit to Hand Held Products (postage paid) with a copy of the dated purchase record attached. Contact the appropriate location below to obtain a Return Material Authorization number (RMA #) before returning the product.

North America

Telephone: (800) 782-4263
Fax: (803) 835-8012
E-mail: naservice@handheld.com

Latin America

Telephone: (803) 835-8000
Telephone: (800) 782-4263
Fax: (239) 263-9689
E-mail: laservice@handheld.com

Brazil

Telephone: +55 (21) 3535-9100
Fax: +55 (21) 3535-9105
E-mail: brservice@handheld.com

Mexico

Telephone: +52 (55) 5203-2100
Fax: +52 (55) 5531-3672
E-mail: mxservice@handheld.com

Europe, Middle East, and Africa

Telephone: +31 (0) 40 2901 633
Fax: +31 (0) 40 2901 631
E-mail: euserice@handheld.com

Asia Pacific

Telephone: +852-2511-3050
Fax: +852-2511-3557
E-mail: apservice@handheld.com

Japan

Telephone: +813-5770-6312

Fax: +813-5770-6313

E-mail: apservice@handheld.com

Online Product Service and Repair Assistance

You can also access product service and repair assistance online at www.handheld.com.

Limited Warranty

Hand Held Products, Inc. ("Hand Held Products") warrants its products to be free from defects in materials and workmanship and to conform to Hand Held Products' published specifications applicable to the products purchased at the time of shipment. This warranty does not cover any Hand Held Products product which is (i) improperly installed or used; (ii) damaged by accident or negligence, including failure to follow the proper maintenance, service, and cleaning schedule; or (iii) damaged as a result of (A) modification or alteration by the purchaser or other party, (B) excessive voltage or current supplied to or drawn from the interface connections, (C) static electricity or electro-static discharge, (D) operation under conditions beyond the specified operating parameters, or (E) repair or service of the product by anyone other than Hand Held Products or its authorized representatives.

This warranty shall extend from the time of shipment for the duration published by Hand Held Products for the product at the time of purchase ("Warranty Period"). Any defective product must be returned (at purchaser's expense) during the Warranty Period to Hand Held Products' factory or authorized service center for inspection. No product will be accepted by Hand Held Products without a Return Materials Authorization, which may be obtained by contacting Hand Held Products. In the event that the product is returned to Hand Held Products or its authorized service center within the Warranty Period and Hand Held Products determines to its satisfaction that the product is defective due to defects in materials or workmanship, Hand Held Products, at its sole option, will either repair or replace the product without charge, except for return shipping to Hand Held Products.

EXCEPT AS MAY BE OTHERWISE PROVIDED BY APPLICABLE LAW, THE FOREGOING WARRANTY IS IN LIEU OF ALL OTHER COVENANTS OR WARRANTIES, EITHER EXPRESSED OR IMPLIED, ORAL OR WRITTEN, INCLUDING, WITHOUT LIMITATION, ANY IMPLIED WARRANTIES OF MERCHANTABILITY OR FITNESS FOR A PARTICULAR PURPOSE.

HAND HELD PRODUCTS' RESPONSIBILITY AND PURCHASER'S EXCLUSIVE REMEDY UNDER THIS WARRANTY IS LIMITED TO THE REPAIR OR REPLACEMENT OF THE DEFECTIVE PRODUCT. IN NO EVENT SHALL HAND HELD PRODUCTS BE LIABLE FOR INDIRECT, INCIDENTAL, OR CONSEQUENTIAL DAMAGES, AND, IN NO EVENT, SHALL ANY LIABILITY OF HAND HELD PRODUCTS ARISING IN CONNECTION WITH

ANY PRODUCT SOLD HEREUNDER (WHETHER SUCH LIABILITY ARISES FROM A CLAIM BASED ON CONTRACT, WARRANTY, TORT, OR OTHERWISE) EXCEED THE ACTUAL AMOUNT PAID TO HAND HELD PRODUCTS FOR THE PRODUCT. THESE LIMITATIONS ON LIABILITY SHALL REMAIN IN FULL FORCE AND EFFECT EVEN WHEN HAND HELD PRODUCTS MAY HAVE BEEN ADVISED OF THE POSSIBILITY OF SUCH INJURIES, LOSSES, OR DAMAGES. SOME STATES, PROVINCES, OR COUNTRIES DO NOT ALLOW THE EXCLUSION OR LIMITATIONS OF INCIDENTAL OR CONSEQUENTIAL DAMAGES, SO THE ABOVE LIMITATION OR EXCLUSION MAY NOT APPLY TO YOU.

All provisions of this Limited Warranty are separate and severable, which means that if any provision is held invalid and unenforceable, such determination shall not affect the validity of enforceability of the other provisions hereof. Use of any peripherals not manufactured/sold by Hand Held Products voids the warranty. This includes but is not limited to: cables, power supplies, cradles, and docking stations. Hand Held Products, Inc. extends these warranties only to the first end-users of the products. These warranties are nontransferable.

The limited duration of the warranty for the 3200 is for two (2) years and six (6) months for the cables.

Appendix A

Symbology Chart

Symbology	Code ID	AIM ID	Hex ID	Symbology	Code ID	AIM ID	Hex ID
China Post	Q]X0	51	IATA 2 of 5	f]R <i>m</i>	66
Codabar	a]F <i>m</i>	61	Interleaved 2 of 5	e]I <i>m</i>	65
Codablock F	q]O <i>m</i>	71	Korea Post	?]X0	3F
Code 2 of 5	f]R <i>m</i>	66	Matrix 2 of 5	m]X0	6D
Code 11	h]H <i>m</i>	68	MSI	g]M <i>m</i>	67
Code 16K	o]K <i>m</i>	6F	No Read			9C
Code 39	b]A <i>m</i>	62	Plessey Code	n]P0	6E
Code 32 Pharmaceutical (PARAF)	<]X0	3C	PosiCode	W]p <i>m</i>	57
Code 49	l]T <i>m</i>	6C	Reduced Space Symbology (RSS-14, RSS Limited, RSS Expanded)	y]e <i>m</i>	79
Code 93	i]G <i>m</i>	69	Telepen	t]B <i>m</i>	74
Code 128	j]C <i>m</i>	6A	Trioptic Code	=]X0	3D
UCC/EAN-128	l]C1	49	UPC-A	c]E0	63
EAN/JAN-8	D]E4	44	UPC-A with Extended Coupon Code	c]E3	63
EAN/JAN-13	d]E0	64	UPC-E	E]E0	45
EAN-13 with Extended Coupon Code	d]E3	64	<i>All Symbologies</i>			99

Note: “m” represents the AIM modifier character. Refer to *International Technical Specification, Symbology Identifiers*, for AIM modifier character details.

Note: Prefix/Suffix entries for specific symbologies override the universal (*All Symbologies*, 99) entry.

Refer to [Data Editing](#) beginning on page 4-1 and [Data Formatting](#) beginning on page 5-1 for information about using Code ID and AIM ID.

ASCII Conversion Chart (Code Page 1252)

Note: This table applies to U.S. style keyboards. Certain characters may differ depending on your Country Code/PC regional settings.

Dec	Hex	Char	Dec	Hex	Char	Dec	Hex	Char	Dec	Hex	Char
0	00	NUL	32	20		64	40	@	96	60	'
1	01	SOH	33	21	!	65	41	A	97	61	a
2	02	STX	34	22	"	66	42	B	98	62	b
3	03	ETX	35	23	#	67	43	C	99	63	c
4	04	EOT	36	24	\$	68	44	D	100	64	d
5	05	ENQ	37	25	%	69	45	E	101	65	e
6	06	ACK	38	26	&	70	46	F	102	66	f
7	07	BEL	39	27	'	71	47	G	103	67	g
8	08	BS	40	28	(72	48	H	104	68	h
9	09	HT	41	29)	73	49	I	105	69	i
10	0A	LF	42	2A	*	74	4A	J	106	6A	j
11	0B	VT	43	2B	+	75	4B	K	107	6B	k
12	0C	FF	44	2C	,	76	4C	L	108	6C	l
13	0D	CR	45	2D	-	77	4D	M	109	6D	m
14	0E	SO	46	2E	.	78	4E	N	110	6E	n
15	0F	SI	47	2F	/	79	4F	O	111	6F	o
16	10	DLE	48	30	0	80	50	P	112	70	p
17	11	DC1	49	31	1	81	51	Q	113	71	q
18	12	DC2	50	32	2	82	52	R	114	72	r
19	13	DC3	51	33	3	83	53	S	115	73	s
20	14	DC4	52	34	4	84	54	T	116	74	t
21	15	NAK	53	35	5	85	55	U	117	75	u
22	16	SYN	54	36	6	86	56	V	118	76	v
23	17	ETB	55	37	7	87	57	W	119	77	w
24	18	CAN	56	38	8	88	58	X	120	78	x
25	19	EM	57	39	9	89	59	Y	121	79	y
26	1A	SUB	58	3A	:	90	5A	Z	122	7A	z
27	1B	ESC	59	3B	;	91	5B	[123	7B	{
28	1C	FS	60	3C	<	92	5C	\	124	7C	
29	1D	GS	61	3D	=	93	5D]	125	7D	}
30	1E	RS	62	3E	>	94	5E	^	126	7E	~
31	1F	US	63	3F	?	95	5F	_	127	7F	

Dec	Hex	Char	Dec	Hex	Char	Dec	Hex	Char	Dec	Hex	Char
128	80	€	160	A0		192	C0	À	224	E0	à
129	81	□	161	A1	ı	193	C1	Á	225	E1	á
130	82	,	162	A2	ç	194	C2	Â	226	E2	â
131	83	f	163	A3	£	195	C3	Ã	227	E3	ã
132	84	„	164	A4	□	196	C4	Ä	228	E4	ä
133	85	...	165	A5	¥	197	C5	Å	229	E5	å
134	86	†	166	A6	ı	198	C6	Æ	230	E6	æ
135	87	‡	167	A7	§	199	C7	Ç	231	E7	ç
136	88	^	168	A8	ˆ	200	C8	È	232	E8	è
137	89	‰	169	A9	©	201	C9	É	233	E9	é
138	8A	Š	170	AA	š	202	CA	Ê	234	EA	ê
139	8B	<	171	AB	«	203	CB	Ë	235	EB	ë
140	8C	Œ	172	AC	¬	204	CC	Ì	236	EC	ì
141	8D	□	173	AD	-	205	CD	Í	237	ED	í
142	8E	Ž	174	AE	®	206	CE	Î	238	EE	î
143	8F	□	175	AF	˘	207	CF	Ï	239	EF	ï
144	90	□	176	B0	°	208	D0	Ð	240	F0	ð
145	91	‘	177	B1	±	209	D1	Ñ	241	F1	ñ
146	92	’	178	B2	²	210	D2	Ò	242	F2	ò
147	93	“	179	B3	³	211	D3	Ó	243	F3	ó
148	94	”	180	B4	´	212	D4	Ô	244	F4	ô
149	95	•	181	B5	µ	213	D5	Õ	245	F5	õ
150	96	–	182	B6	¶	214	D6	Ö	246	F6	ö
151	97	—	183	B7	·	215	D7	×	247	F7	÷
152	98	˜	184	B8	¸	216	D8	Ø	248	F8	ø
153	99	™	185	B9	¹	217	D9	Ù	249	F9	ù
154	9A	š	186	BA	º	218	DA	Ú	250	FA	ú
155	9B	›	187	BB	»	219	DB	Û	251	FB	û
156	9C	œ	188	BC	¼	220	DC	Ü	252	FC	ü
157	9D	□	189	BD	½	221	DD	Ý	253	FD	ý
158	9E	ž	190	BE	¾	222	DE	Þ	254	FE	þ
159	9F	ÿ	191	BF	¿	223	DF	ß	255	FF	ÿ

Code Page Mapping of Printed barcodes

Code pages define the mapping of character codes to characters. If the data received does not display with the proper characters, it may be because the barcode being scanned was created using a code page that is different from the one the host program is expecting. If this is the case, select the code page with which the barcodes were created. The data characters should then appear properly.

Note: The Code Page option is available for Code 39, Code 93, and Code 128.

Code Page	Standard	Description
1	CP ISO646	
2 (Default)	ISO 2022	Automatic National Replacement Characters
3	CP Binary	
82	ISO 2022 11 Swe	Swedish Replacement Characters
83	ISO 2022 69 Fra	French/Belgium Replacement Characters
81	ISO 2022 25 Fra	French/Belgium Replacement Characters
84	ISO 2022 11 Ger	German Replacement Characters
85	ISO 2022 11 Ita	Italian Replacement Characters
86	ISO 2022 11 Swi	Swiss Replacement Characters
87	ISO 2022 11 UK	British Replacement Characters
88	ISO 2022 11 Dan	Danish Replacement Characters
89	ISO 2022 11 Nor	Norwegian Replacement Characters
90	ISO 2022 11 Spa	Spanish Replacement Characters

Sample Symbols

UPC A

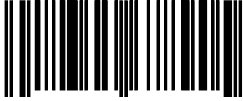

0 123456 7890

Interleaved 2 of 5



1234567890

Code 128



Code 128

EAN 13

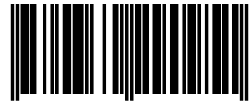

9 780330 290951

EAN 8

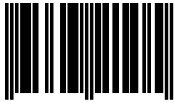

654 3210 5

UPC-E



0 456123 8

Sample Symbols

Code 39

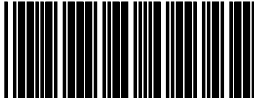

BC321

Codabar

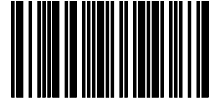

A13579B

Code 93



123456-9\$

Straight 2 of 5 Industrial

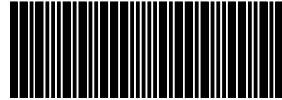

123456

Matrix 2 of 5



6543210

RSS-14



(01)00123456789012

Programming Chart



0



2



4



6



8



A



C



E



1



3



5



7



9



B



D



F



Discard



Save

Note: If you make an error while scanning the letters or digits (before scanning Save), scan Discard, scan the correct letters or digits, and **Save**.

Hand Held Products, Inc.

700 Visions Drive

P.O. Box 208

Skaneateles Falls, NY 13153-0208